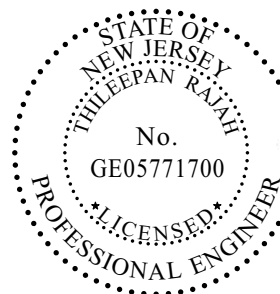




# GEOTECHNICAL RECOMMENDATIONS REPORT

**Clinton Commons**  
Town of Clinton, Hunterdon County,  
New Jersey

October 30, 2023



Thileepan Rajah, P.E.

NJ PE No. 24GE05771700

*Vatsal Shah* 10/30/2023

Vatsal Shah, P.E., Ph.D.

NJ PE No. 24GE04932300

# Table of Contents

<b>1</b>	<b>Executive Summary .....</b>	<b>1</b>
<b>2</b>	<b>Project Understanding .....</b>	<b>3</b>
<b>3</b>	<b>Methodology .....</b>	<b>4</b>
3.1	Test Borings .....	4
3.2	Phase II Investigations .....	6
3.3	Investigations Performed By Others .....	7
<b>4</b>	<b>Geology and Subsurface Conditions .....</b>	<b>7</b>
4.1	Results of Phase II Investigations Completed by ANS Geo .....	7
4.1.1	Previous Standard Penetration Tests by ANS Geo.....	8
4.2	Generalized Subsurface Profile .....	8
4.2.1	Region 1.....	8
4.2.2	Region 2.....	8
4.2.3	Region 3.....	9
4.2.4	Bedrock.....	9
4.2.5	Proposed Sewer Location Near Central Avenue.....	10
4.3	Groundwater Conditions.....	10
4.4	Frost Depth .....	10
<b>5</b>	<b>Laboratory Results.....</b>	<b>10</b>
5.1	Modified Proctor Compaction Testing.....	11
<b>6</b>	<b>Seismic Site Classification .....</b>	<b>11</b>
<b>7</b>	<b>Stormwater Basin Recommendations .....</b>	<b>12</b>
<b>8</b>	<b>Foundation Recommendations .....</b>	<b>12</b>
8.1	Deep Foundation Option for Region 3 - Helical Pile Recommendations .....	15
8.2	Retaining Wall Design .....	15
<b>9</b>	<b>Construction Recommendations .....</b>	<b>15</b>
9.1	Excavation.....	15
9.1.1	Excavation of Rock.....	16
9.2	Dewatering.....	16
9.2.1	Groundwater Runoff Maintenance .....	16
9.3	Subgrade Preparation and Compaction.....	16
9.3.1	Foundation Subgrade Quality Assurance .....	18
9.3.2	Helical Pile Installation Recommendations .....	18
9.3.3	Retaining Wall Foundation Preparation .....	19
9.3.4	Bedrock Strength Reduction Mitigation.....	19
9.4	Backfilling and Re-use of Native Soils .....	19
9.5	Recommended Services .....	20
9.6	Karst Mitigation Plan.....	20
<b>10</b>	<b>Limitations .....</b>	<b>21</b>



**Tables**

Table 1: ANS Geo’s Subsurface Exploration Summary ..... 5  
 Table 2: Borings In Footprint of Proposed Structures ..... 6  
 Table 3: Percussion Probe Summary ..... 6  
 Table 4: Phase II Test Borings: May and September 2022 ..... 8  
 Table 5: Sieve Analysis Results.....10  
 Table 6: Atterberg Limits Testing .....11  
 Table 7: Rock Strength Testing .....11  
 Table 8: Modified Proctor Test Results .....11  
 Table 9: Bearing Capacities for Proposed Structures By Bearing Material.....14  
 Table 10: Geotechnical Design Parameters.....14  
 Table 11: Recommended Gradation of Structural Fill .....17

**Figures**

Figure 1: Project Vicinity Map ..... 3  
 Figure 2: Project Site Map ..... 4  
 Figure 3: Bearing Surface Regions .....13

**Appendices**

Appendix A – Investigation Location Plans and Bearing Surface Region Plan  
 Appendix B – Test Boring Logs  
 Appendix C – NRCS Soil Report  
 Appendix D – Laboratory Results  
 Appendix E – Seismic Site Class Data  
 Appendix F – Retaining Wall Design by Others  
 Appendix G – ANS Geo Phase II Geophysical Investigation Report  
 Appendix H – ANS Geo Karst Mitigation Plan

## 1 Executive Summary

ANS Geo, Inc. is pleased to present this Geotechnical Recommendations Report in accordance with the Soils and Foundations Chapter of the New Jersey Edition of the 2021 International Building Code (NJ-IBC 2021) to Concept Engineering Consultants (Client) for use in the design and construction of the Clinton Commons townhomes and commercial development project in the Town of Clinton, Hunterdon County, New Jersey. The contents of this report summarize the data gathered from our most recent subsurface investigation program which took place from August 21<sup>st</sup> to August 23<sup>rd</sup>, 2023, at the project site, previous subsurface and geophysical investigation data, and our foundation recommendations for the proposed new structures.

The 28.06-acre project site is located at Lot 32 of Block 14, in the Town of Clinton. The site is bounded by Route 31 to the North, seven private residences along George's Place to the East, seven private residences, Clinton Presbyterian Church and Riverside Cemetery along Center Street to the South, and South Branch River to the West. An approximately 0.38-acre lot, occupied by a single-family residential home, lies at the end of Central Avenue, which reaches approximately 300 feet towards the center of the project site from Center Street to the South.

Previously, ANS Geo was retained by Concept Engineering Consultants to conduct a geophysical investigation to evaluate potential karst conditions at the proposed Clinton Commons project site and complete a Phase II Carbonate Area District Report per the Municipal Zoning Regulations of the Town of Clinton. This investigation and report followed investigations of this same project site completed by Engineering and Land Planning Associates in June 2009 and April 2020. ANS Geo completed 12 test borings and a percussion probe program to corroborate the previously obtained data. The Phase II Geophysical Investigation Report and its appendices as previously submitted to the Client and the Town of Clinton are provided as **Appendix G** to this report.

Considering the previous investigation report and the Client's need for geotechnical recommendations per NJ-IBC 2021, ANS Geo developed an investigation plan, consolidated our findings, and made use of all past and recent data to generate the recommendations found in this report, which are summarized below:

- a) Following an Electrical Resistivity Imaging survey of the project site performed by ANS Geo in February and March of 2022, a total of 12 borings and ten (10) percussion probes were advanced within the project site, also by ANS Geo, in May and September of 2022. Soils encountered generally consisted of silty gravels and sands with varying amounts of silts, clays, residual soil, and weathered bedrock. The bedrock surface varied from existing grade to 23 feet below ground surface (BGS). The geophysical testing identified three regions of the project site which were most likely to have karstic formations; these regions were then investigated and considered as unlikely to have conditions problematic to construction based on borings and percussion probes, however, a Karst Mitigation Plan has been prepared to be used during construction for any unforeseen karst conditions encountered during construction.
- b) Seven additional borings were advanced at the project site specifically within in the footprint of proposed structures and in proximity to the proposed utility near Center Street by ANS Geo between August 21 and 23, 2023. Soils encountered generally consisted of silty gravels and silt with varying amounts of sands and clays, underlain by residual soil, clays, and weathered bedrock. The results of this investigation and the depth to bedrock are consistent with past investigations, with the deepest bedrock surface encountered at 25 feet BGS.

- c) Groundwater was not observed in any of the test borings, though geologic mapping indicates groundwater may be encountered within six feet of the ground surface in a Northwestern portion of the site that does not underly any proposed construction.
- d) The Seismic Site Classification based on completed borings and ASCE 7-10 mapping is **Seismic Site Class C**.
- e) ANS Geo understands that a retaining wall has been proposed to manage the changes in elevation throughout the development. The allowable bearing capacity for the proposed retaining wall is 1,000 psf. The design of the retaining wall has been completed by others. For ease of reference, ANS Geo has included the proposed retaining wall design in **Appendix F**.
- f) The allowable bearing capacities and bearing resistance for structures vary throughout the project site due to the range of depths to bedrock and strength properties of surficial soils. Therefore, ANS Geo has identified Regions 1, 2, and 3 of the project site as distinct in terms of the bearing material and calculated values for construction. Helical piles may be considered as an alternative foundation option for the food market building. See Section 8 for foundation recommendations and Figure 3 depicting these portions of the project site, and **Appendix A** for the same figure. The Table below summarizes the bearing values across the project site.

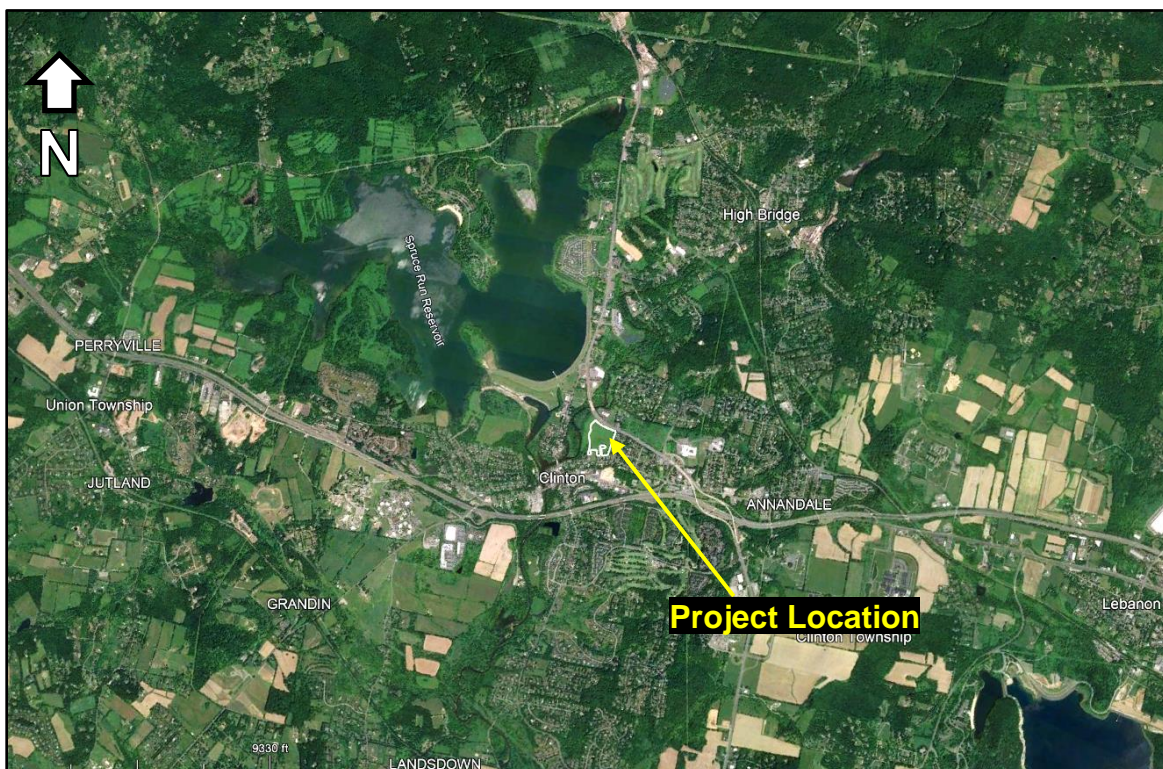
Footing Type	Bearing Stratum	Ultimate Bearing Capacity (psf)	Allowable Bearing Capacity (psf)
<b>Region 1: Townhome Buildings 1, 3, 6, 7, 8, 9, 10</b>			
Strip (Wall) (B = 3 ft, L = 30 ft)	Competent Bedrock	8,000	4,000
Spread (Column) (B = 5 ft, L = 5 ft)			
<b>Region 2: Commercial Restaurant, Townhome Buildings 2, 4, 5</b>			
Strip (Wall) (B = 3 ft, L = 30 ft)	Crushed Stone/ Structural Fill Over Dense Gravels	6,000	2,500
Spread (Column) (B = 5 ft, L = 5 ft)			
<b>Region 3</b>			
<b>Townhome Building 11/Gas Station</b>			
Strip (Wall) (B = 1.5 ft, L = 30 ft)	Crushed Stone/ Structural Fill Over Gravel and Clay	6,000	3,000
Spread (Column) (B = 3 ft, L = 3 ft)		6,000	3,000
<b>Food Market</b>			
Strip (Wall) (B = 1.5 ft, L = 30 ft)	Crushed Stone/ Structural Fill Over Gravel and Clay	6,000	3,000
Spread (Column) (B = 3 ft, L = 3 ft)		6,000	3,000
Mat Footing (150 ft by 150 ft)		1,000	750

## 2 Project Understanding

Concept Engineering Consultants was selected to provide engineering services for the development of the 28.06-acre open farm space located at Block 14, Lot 32, at the end of Central Avenue in the Town of Clinton in Hunterdon County, New Jersey. This development includes the construction of the following 14 structures of the following approximate square-footages: a food market of 22,000 square feet, a convenience store of 5,700 square feet with a gas station, a restaurant or retail building of 2,600 square feet, one residential building of 3,750 square feet, four residential buildings of 5,000 square feet each, five residential buildings of 7,500 square feet each, and one residential building of 8,750 square feet, which combine for 56 townhomes. ANS Geo has been retained by the Client to provide geotechnical engineering services in support of this development. In addition, infrastructural elements including but not limited to roadways and parking lots, utilities, a retaining wall system, and a stormwater infiltration basin are proposed as part of the proposed construction. While a bearing capacity and construction recommendations for the proposed retaining wall are provided in this report, detailed designs for each of these infrastructural elements will be performed by others or presented in a separate memorandum or report from this recommendations report. As preliminary borings and Phase II Carbonate Rock Area reporting have both been completed, this report shall serve to further our investigation of the subsurface conditions at key locations through the project site, and to provide foundation recommendations for the proposed new construction.

The location of the project site is shown in Figure 1 and Figure 2 in different scales for better understanding. One boring location plan which depicts the seven borings drilled in August 2023, and an Investigation Location Plan, which depicts the location of all as-drilled borings and all previous geophysical investigations at the project site, including the seven borings drilled in August of 2023, are provided as **Appendix A**.

**Figure 1: Project Vicinity Map**



*(Source: Google Earth accessed on August 10, 2023)*



Figure 2: Project Site Map



(Source: Google Earth accessed on August 10, 2023)

### 3 Methodology

#### 3.1 Test Borings

ANS Geo retained Boring Brothers, Inc. of Egg Harbor Township, New Jersey to advance test borings. The first mobilization occurred between May 11<sup>th</sup> and May 13<sup>th</sup>, 2022, the second mobilization occurred between September 12<sup>th</sup> and September 20<sup>th</sup>, 2022, and the third mobilization occurred between August 21<sup>st</sup> and August 23<sup>rd</sup>, 2023. An as-drilled boring location plan, depicting all borings logged by ANS Geo at the project site to-date, is shown in the Investigation Location Plan, provided in **Appendix A**.

A CME-55LC track-mounted drill rig was used to collect soil samples using the Standard Penetration Test (SPT) Method in accordance with ASTM Standard D1586 – Standard Test Method for SPT and Split-Barrel Sampling of soils. Soil samples were collected continuously from existing ground surface to the weathered rock as indicated by refusal of the split-spoon or ten feet below ground surface and at five-foot intervals thereafter, whichever occurred first. Each split-spoon was driven using 140 pounds of hammer force with a free fall of 30 inches. Blow counts were recorded at 6-inch intervals over a total driven depth of 24 inches for each SPT sample. The N-Value is defined as the number of blows required to drive the split-spoon sampler through a 12-inch interval after the initial 6 inches of split-spoon penetration. SPT split-spoon refusal is when 50 blows per foot (bpf) are required to drive the split-spoon over a 6-inch interval.

Upon encountering split spoon refusal, mud rotary drilling techniques were used to advance the boring to bedrock where rock coring began. Either minimum five or ten feet of rock coring were completed using an

NQ-size diamond bit in each boring. Recovered rock cores were visually classified, and calculation of recovery and Rock Quality Designation (RQD) were completed in the field.

The locations of test borings, which were part of this most recent August 2023 exploration program, proposed by ANS Geo and confirmed by Concept Engineering Consultants and a representative of the Town of Clinton, were located within the footprints of the proposed food market (two borings), townhome buildings 1, 2, 5, 11, and in close proximity to the sewer along Central Avenue. Test borings were overseen and logged by an ANS Geo representative under the direction of a Professional Engineer licensed in the State of New Jersey. Upon completion the boreholes were backfilled to existing grade with soil cuttings and bentonite chips. Typed test boring logs for borings performed in August 2023, including soil sampling and rock coring, are provided in **Appendix B**. Table 1 below summarizes all borings performed by ANS Geo including exploration programs performed in May and September of 2022.

**Table 1: ANS Geo’s Subsurface Exploration Summary**

Borehole ID	Approx. Existing Elevation (feet)	Approx. Proposed Elevation (feet)	Approx. Elevation Difference (feet)	Proposed Boring Depth (feet)	Encountered Top of Rock (feet)	Total Depth of Rock Coring (feet)	Borehole Termination Depth (feet)
B-01	235	241	-6	40	17	10	27
B-02	240	237	3	50	20	5	25
B-03	253	256	-3	40	20	10	30
B-04	222	224	-2	40	23	10	33
B-05	246	246	0	40	4	10	14
B-06	269	264	5	40	10	30	40
B-07	245	244	1	40	5	10	15
B-08	264	263	1	40	10	10	20
B-09	249	242	7	40	3	10	13
B-10	258	256	2	40	10	10	20
B-12	260	261	-1	40	10	10	20
B-13	235	225	10	40	10	10	20
B-14	245	242	3	50	14	5	19
B-15	253	252	1	40	4	10	14
B-14	245	242	3	50	14	5	19
B-16	232	235	-3	50	25	5	30
B-17	275	270	5	50	7	10	17
B-18	276	273	3	50	9	5	14
B-19	255	255	0	50	8	5	12
B-20	246	250	-4	50	11	10	21

ANS Geo notes that the initial proposed location of boring B-20, for the sewer line near Central Avenue, was located at the bottom of a steep slope. Therefore, based on safety concerns of performing a test boring with the drill rig in a precarious position, the boring was moved approximately 120 feet North from the proposed location so the slope would not need to be traversed. It is expected that construction equipment will be able to traverse this area at a later date, as appropriate equipment will be available for proper earthmoving and rock removal at that stage.

Table 2 below shows the following information as it relates to the footprint-area encompassed by each of the 14 listed structures: Area of each footprint in square-feet, number of borings performed in each building footprint to-date, and the 'square-foot area per boring'.



**Table 2: Borings In Footprint of Proposed Structures Per Square-Foot Area**

Structure Name	Area (Square Feet) (Approximated for Residential Buildings)	Number of Borings To Date	Area (SF) per Number Borings
Foodmarket	21998	5	4400
Retail	2558	1	2558
Gas Station	5690	3	1897
BLDG 1	7500	2	3750
BLDG 2	7500	2	3750
BLDG 3	5000	1	5000
BLDG 4	5000	2	2500
BLDG 5	7500	1	7500
BLDG 6	5000	1	5000
BLDG 7	8750	3	2917
BLDG 8	3750	1	3750
BLDG 9	5000	2	2500
BLDG 10	7500	2	3750
BLDG 11	7500	2	3750

### 3.2 Phase II Investigations

As part of the Phase II Investigation, ANS Geo completed geophysical investigation program consisting of Electrical Resistivity Imaging (ERI) surveys at the project site on February 28<sup>th</sup> and March 1<sup>st</sup>, 2022. The ERI surveys focused on areas of karst features indicated in Phase I Investigations completed by others. A Geophysics Investigation Location Plan, which shows the location of all geophysical survey transects (lines) as they correspond to the proposed site development layout is provided as page 4 of **Appendix A**. Using the results of the ERI surveys, ANS Geo completed percussion probes and borings focused on areas of interest to confirm any existing karst features.

ANS Geo completed a total of 12 test borings between May 11<sup>th</sup> and May 13<sup>th</sup>, 2022, and between September 12<sup>th</sup> and September 20<sup>th</sup>, 2022. Percussion probes were completed by Hayduk Enterprises of Factoryville, Pennsylvania between May 4<sup>th</sup> and May 10<sup>th</sup>, 2022, at the project site. Percussion probes were advanced using ECM-590 Self-Contained Hydraulic Crawler Drill, which uses a drilling hammer with compressed air and a down-the-hole hammer with drilling bit that is advanced by this hammering and rotation action. All percussion probes were advanced a depth of 49 feet BGS and estimated top of rock is based on drilling timing is provided in Table 3 below.

**Table 3: Percussion Probe Summary**

Percussion Probe ID	Estimated Top of Rock (feet)	Completed Depth (feet)
PP-01	7	49
PP-02	7	49
PP-03	7	49
PP-04	4	49
PP-05	24	49
PP-06	7	49
PP-07	12	49
PP-08	18	49
PP-09	6	49
PP-10	5	49

### 3.3 Investigations Performed By Others

As part of Phase I Investigations, subsurface exploration programs developed by the Client's previous geotechnical engineer, E&LP, were performed in June 2009 and April 2020. The first investigation in 2009 consisted of ten (10) soil borings using a Hollow-Stem Auger to depths of at-most 12 feet BGS. In 2020 E&LP oversaw 15 test pits completed on project site. Each investigation provided a minimal amount of qualitative information. Typical engineering parameters, such as standard penetration test (SPT) N-Values, USCS Classification, and detailed soil descriptions at critical depths throughout each exploration are absent from their report; therefore, E&LP's data could not be used for our engineering application.

## 4 Geology and Subsurface Conditions

A desktop review of surficial geology and bedrock geology maps and reports made available by the United States Geological Survey (USGS) was completed prior to conducting our field investigation. The mapping indicates that the predominant bedrock formation within the project boundary is the Allentown Formation consisting primarily of Dolomite. The Lower Beekmantown Group is mapped within the southwestern portion of the site and also consists of Dolomite. Due to the degree of folding and fracturing of the bedrock according to mapping, bedrock may generally present a high degree of dipping. Additionally, a thrust-fault runs northwest to southeast along the southwest boundary of the project site. In addition, Concealed Faults, Anticlines, and Synclines of bedrock masses are mapped within the project site.

ANS Geo additionally reviewed the surficial geology in the project area using the National Resource Conservation Service (NRCS) Web Soil Survey. The NRCS mapping indicates that the upper five feet of soil within the project area consists primarily of the Duffield silt loam unit, which is comprised of silts and clays and shallow unweathered bedrock. The full NRCS soil report is provided as **Appendix C**.

### 4.1 Results of Phase II Investigations Completed by ANS Geo

In the previous investigations, six Electrical Resistivity Imaging (ERI) tests were performed to develop profiles of the density of subsurface materials across the project site. The data was used to characterize the type, depth, and extent of potential karst features at select representative locations. In ANS Geo's previously submitted report dated December 23, 2022, the soil profile was evaluated to be dense with a generally high bedrock surface. A number of possible pockets of epi-karst were identified; these are zones of weathered bedrock or loose gravels, appearing as pockets of low-resistivity material as deep as 30 feet BGS and other higher-resistivity material. These pockets were formed by karst activity which had previously occurred at the project at some point in the geologic history of the area. Additionally, one range of soil imaged by ERI-04 yielded a resistivity of over 10,000 Ohmmeters, indicating a possible soil-filled, karstic anomaly. ANS Geo completed a Geotechnical Investigation Program between May 2022 and September 2022 consisting of 12 test borings and ten percussion probes located to target these possible karstic conditions.

This geophysical program approached all significant portions of the site which were likely to have karst formations. It should be noted, while investigations were completed across the project site, with any geotechnical investigation scope, there remains a possibility of variability in the site conditions. Despite our thorough investigations, there may be karstic conditions at locations within the site that were not explicitly sampled, and may only be encountered during construction. ANS Geo has provided a Karst Management and Mitigation Plan as **Attachment H** to provide guidance on potential field-observed karst features during construction.

### 4.1.1 Previous Standard Penetration Tests by ANS Geo

ANS Geo performed 12 borings at the project site between May and September 2022. Table 4 below lists each boring with the approximate elevation as-drilled based on client provided contour mapping, against proposed elevation at the same location, and bedrock depth information.

**Table 4: Phase II Test Borings: May and September 2022**

Borehole ID	Approx. Existing Elevation (feet)	Approx. Proposed Elevation (feet)	Approx. Elevation Difference (feet)	Proposed Boring Depth (feet)	Encountered Top of Rock (feet)	Total Depth of Rock Coring (feet)	Borehole Termination Depth (feet)
B-01	235	241	-6	40	17	10	27
B-03	253	256	-3	40	20	10	30
B-04	222	224	-2	40	23	10	33
B-05	246	246	0	40	4	10	14
B-06	269	264	5	40	10	30	40
B-07	245	244	1	40	5	10	15
B-08	264	263	1	40	10	10	20
B-09	249	242	7	40	3	10	13
B-10	258	256	2	40	10	10	20
B-12	260	261	-1	40	10	10	20
B-13	235	225	10	40	10	10	20
B-15	253	252	1	40	4	10	14

## 4.2 Generalized Subsurface Profile

ANS Geo has provided the generalized subsurface conditions below based upon the observations made during ANS Geo's recent and past geotechnical investigations. The general subsurface conditions on site consisted of overburden soil over bedrock.

### 4.2.1 Region 1

The subsurface conditions encountered throughout borings B-05, B-07, B-09, B-15, and B-17 were used to provide a generalized profile below. The test boring logs provided in **Appendix B** and **Appendix G**, should be reviewed for location-specific subsurface conditions.

- SANDS AND GRAVELS WITH FINES (SM, SP):**  
 Medium dense to very dense coarse to fine sands with various amounts of silt and gravel was encountered in all borings from existing ground surface to seven feet BGS in all borings. The N-Values of soils in this stratum ranged from seven to over 50 bpf. Bedrock was encountered beneath this stratum.

### 4.2.2 Region 2

The subsurface conditions encountered throughout borings B-07, B-08, B-18, and B-19 were used to provide a generalized profile below. The test boring logs provided in **Appendix B** and **Appendix G**, should be reviewed for location-specific subsurface conditions.

- **OVERBURDEN SANDS AND FINE-GRAINED SOILS (SM, SP, ML, SM, SC):**  
Medium dense to dense coarse to fine sands and soft to very stiff silts with various amounts of gravel and clay were encountered from existing ground surface to depths ranging from one to five feet BGS. The N-Values of soils in this stratum ranged from four to over 50 bpf.
- **SANDS AND GRAVELS WITH FINES (GM, SM, GP, SP):**  
Medium dense to very dense coarse to fine gravels and sands with various amounts of silt was encountered from below the overburden sands stratum to ten feet BGS. Standard penetration tests in this layer encountered N-values over 50 bpf or refusal. Bedrock was encountered beneath this stratum.

### 4.2.3 Region 3

The subsurface conditions encountered throughout borings B-01, B-02, B-03, B-04, B-14, and B-16 were used to provide a generalized profile below. The test boring logs provided in **Appendix B** and **Appendix G**, should be reviewed for location-specific subsurface conditions.

- **OVERBURDEN SILTS (ML, SM):**  
Stiff to hard silts of various sand and gravel contents were encountered from existing ground surface to depths ranging from one to five feet BGS. The N-Values of soils in this layer ranged from eight to over 48 bpf.
- **SANDS AND GRAVELS WITH FINES (GM, SM, GP, SP):**  
Medium dense to very dense coarse to fine gravels and sands with various amounts of silt was encountered in all borings from existing ground surface or below the overburden sands stratum to as deep as 20 feet BGS. The N-Values of soils in this layer ranged from seven to over 50 bpf.
- **CLAYS AND SILTS (CL, ML):**  
A layer of medium stiff to stiff clays and silts with varying amounts of sand and gravel was encountered in borings B-1, B-2, B-4, B-6, and B-16 between the sands and gravels and bedrock. This stratum ranged from three to ten feet in thickness. The N-Values of soils in this layer ranged from five to over 11 bpf.
- **WEATHERED ROCK:**  
Weathered bedrock material was encountered underneath the clays and silts or sands and gravels in all borings. This stratum ranged from one to seven feet in thickness and was about four feet thick on average. As split spoon sampling typically resulted in refusal in this layer, this soil can be described as very dense recoveries of coarse to fine gravel, with varying amounts of sand, silt, and clay. Bedrock was encountered beneath this stratum.

### 4.2.4 Bedrock

In all 19 borings, a minimum of five feet rock core was completed. Dolomitic Limestone was encountered beneath the sand and gravel layer or the weathered rock between three and 25 feet BGS in all borings. Bedrock was cored and classified as fine to medium-grained, slightly to highly weathered, and weak to very strong with very closely to widely spaced discontinuities. All borings were terminated in this layer after one to four rock cores, between 13 feet and 40 feet BGS. The rock core recovery ranged from 0% to 100% and RQD was calculated to range from 0% to 97%.

### 4.2.5 Proposed Sewer Location Near Central Avenue

The subsurface conditions encountered in borings B-15 and B-20 were used to provide information about the depth to bedrock. Refusal was encountered after about three feet of overburden silts and sands in both borings. In B-15, two rock core runs were advanced from four feet to 14 feet BGS. In boring B-20, ten feet of rock coring were performed from 11 to 21 feet BGS. Please see Table 1 for information on the approximate existing and proposed elevations in the vicinity of B-20 and B-15. The test boring logs provided in **Appendix B** and **Appendix G**, should be reviewed for location-specific subsurface conditions.

### 4.3 Groundwater Conditions

Groundwater was not observed in borings that were performed in August 2023. This may be due to fractured dolomitic limestone, and existing natural channels through where groundwater can flow through. Although groundwater was not encountered in our subsurface investigation, the NRCS Soil Report, presented as **Appendix C**, indicated a region West of the where the proposed foodmarket may be built as having groundwater at depth of half a foot to six feet below ground surface. Measures should be taken during construction to address potential groundwater-related challenges. Groundwater levels are also expected to fluctuate based on temperature and seasons.

### 4.4 Frost Depth

The frost line is the depth where the ground is expected to freeze during colder temperatures. Any footings or utilities constructed above frost line can experience frost heaving when the ground freezes and thaws. The frost depth for Hunterdon County is 36 inches BGS; therefore, ANS Geo recommends all footings be installed below the frost depth of 36 inches BGS.

## 5 Laboratory Results

Representative soil samples and rock core sections collected during our May 2022 investigation and our August 2023 investigation were submitted to ANS Consultants' accredited materials testing laboratory. A summary of the sieve laboratory testing results is provided in Table 5, index laboratory test results in Table 6, and rock compressive strength tests in Table 7. Laboratory results are included as two separate sets of lab tests within **Appendix D**.

**Table 5: Sieve Analysis Results**

Sieve Analysis (ASTM D6913)						
Boring ID	Sample ID	Depth (feet)	% Gravel	% Sand	% Fines	% Moisture
B-08	S-2	2-4	0	9.3	90.7	24.1
B-08	S-4	2-4	24.4	48.6	27.0	9.3
B-10	S-3	4-6	3.6	35.8	60.6	21.5
B-12	S-2	2-4	38.4	30.3	31.3	5.9
B-12	S-3	4-6	10.8	42.7	46.5	7.0
B-16	S-3	4-6	39.4	34.7	25.9	9.3
B-17	S-2	2-4	38.2	39.7	22.1	7.7
B-18	S-3	4-6	31.3	48.7	20.0	12.2
B-19	S-2	2-4	28.0	37.9	34.1	9.1

**Table 6: Atterberg Limits Testing**

Boring ID	Sample ID	Depth (feet)	Liquid Limit	Plastic Limit	Plastic Index	Moisture Content	USCS Classification
B-02	S-7	15-17	37	19	18	20.6	CL
B-06	S-2	2-4	46	25	21	16.4	CL
B-10	S-2	2-4	41	24	17	26.7	CL
B-16	S-8	20-22	33	18	15	19.8	CL

**Table 7: Rock Strength Testing**

Boring ID	Core Run	Depth (feet)	Unconfined Compressive Strength (psi)	Unit Weight (pcf)
B-02	R-1	20'8"-21'3"	6,012	171.8
B-05	R-1	7'7"-8'3"	2,620	174.7
B-12	R-1	12'2"-12'7"	2,689	170.7
B-15	R-1	6'5"-7'1"	4,112	170.1
B-18	R-1	9'2"-9'7"	13,965	172.7

## 5.1 Modified Proctor Compaction Testing

To assist with the design of pavement for the multiple proposed permanent roadways and parking lots, ANS collected one bulk sample of approximately four gallons of soil between the existing ground surface to three feet BGS between borings B-18 and B-19 for Modified Proctor Testing for the optimum moisture contents in accordance with ASTM D1557. The test, completed by ANS, yielded an optimum moisture content of 14.6%. See Table 8 for a summary below. Detailed Modified Proctor Testing results are included in **Appendix D**.

**Table 8: Modified Proctor Test Results**

Location ID	Sample Depth (ft)	Optimum Moisture (%)	Maximum Dry Density (pcf)
Bulk S-1 (B-18 to B-19)	0-3	14.6	110.8

It should be noted that this Modified Proctor Test result completed by ANS Geo is based on limited sampling. Therefore, it is assumed that the project's Contractor will collect bulk samples throughout the project site and conduct additional Modified Proctor Tests prior to start of construction. The results shall be reviewed by the project's engineer and the compaction density and moisture content for the project area shall be determined prior to construction.

## 6 Seismic Site Classification

Based on the observations recorded during our subsurface investigation program and utilizing the N-Value method in accordance with the AASHTO, NJDOT, and as prescribed in Chapter 20 of ASCE 7-16, **Site Class C** (very dense soil and soft rock) can be assumed as the average condition across this project site.

The seismic ground motion values for this classification were obtained from the USGS Seismic Hazard Maps, referenced in ASCE 7-16 Standard, and provided as **Appendix E**, and are as follows:



- 0.2 second spectral response acceleration,  $S_s = 0.22$  g
- 1 second spectral response acceleration,  $S_1 = 0.047$  g
- Maximum spectral acceleration for short periods,  $S_{MS} = 0.22$  g
- Maximum spectral acceleration for a 1-second period,  $S_{M1} = 0.06$
- 5% damped design spectral acceleration at short periods,  $S_{DS} = 0.15$
- 5% damped design spectral acceleration at 1-second period,  $S_{D1} = 0.04$

Liquefaction is caused by a fast increase of pore water pressures in loose and soft soils. The site predominantly consists of 2 to 20 feet of medium dense to dense gravels over bedrock. Therefore, there is a low risk of soil liquefaction induced by significant seismic activity, and it is not a concern at this project site. Seismic support data is provided in **Appendix E**.

## 7 Stormwater Basin Recommendations

On the West side of the project site, a stormwater infiltration basin has been proposed. ANS Geo notes that the design and evaluation of stormwater basins and features have been completed by others for the project. The proposed infiltration rate, as communicated to us by the Civil Engineer of Record (E&LP) via the Stormwater Management Report dated April 18, 2023, is expected to match the existing, pre-development infiltration rate for the project site. Should the pre-development infiltration conditions not be maintained, ANS Geo should be contacted and engaged to provide additional recommendations for the design of the stormwater infiltration basin and drainage across the project site.

## 8 Foundation Recommendations

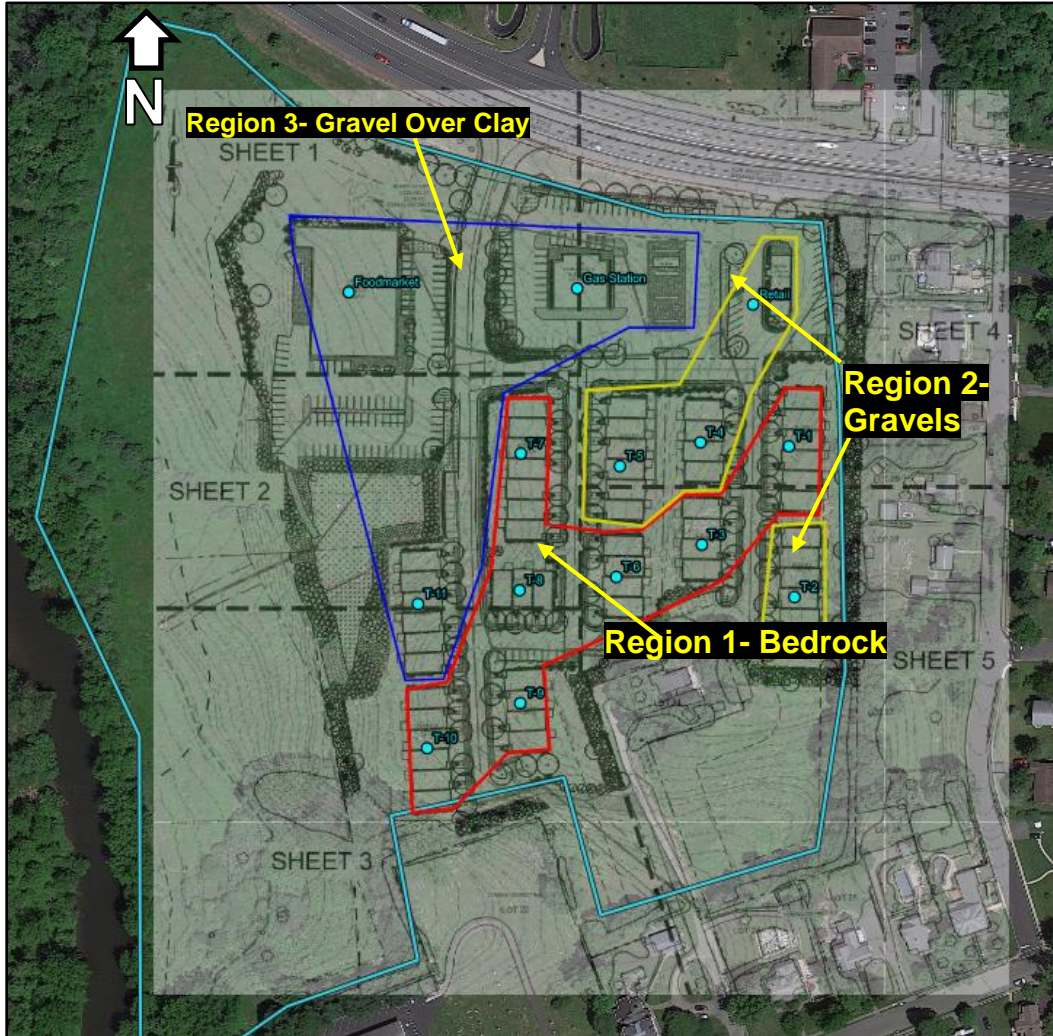
Based on the encountered subsurface conditions, ANS Geo recommends shallow foundations for all fourteen of the proposed new buildings. Assuming a maximum spread (column) foundation with five (5) by five (5) feet in dimensions, and a typical wall (strip) footing of a maximum of three (3) feet wide, ANS Geo calculated bearing capacities and settlement for footings bearing on three different materials based on the different soil qualities and bedrock depth encountered within the proposed footprint of each given structure. ANS Geo also considered the elevation at which each structure is likely to be founded. Note that the elevations provided for the borings as-drilled are approximate, and will not lead to precise comparisons with the proposed new construction, but provide an approximation. It should be noted that soil strata varied widely throughout the project site.

Based on the subsurface investigation, native material throughout the project site has fine content greater than ten percent. Therefore, ANS Geo recommends over-excavating a minimum of twelve (12) inches of existing native material and backfilling with twelve (12) inches of compacted 3-inch sized crushed stone or recommended structural fill as per Table 11 in Section 9.3. In the case of either type of footing bearing on bedrock, the subgrade shall be prepared as specified in Section 9.3.

ANS Geo has calculated spread (column) footings with assumed maximum dimensions five (5) feet bearing in Region 1 and Region 2, but strip (wall) footings of a maximum width of three feet may only be used in Region 1, on bedrock, and a maximum width of 1.5 feet in Region 2, over gravel. Strip footings of three (3) feet wide and square footings of five (5) feet wide bearing on structural fill over gravel and clay in Region 3 were calculated by ANS Geo to cause primary consolidation in excess of one inch. Therefore, maximum dimensions of spread and strip footings are smaller in Region 3. See Figure 3 below for a depiction of each region within the project site defined by estimated bearing material. Note that the regions

identified in the figure below are approximate and may vary upon excavation. It is possible that a different material than indicated by the figure below may be encountered at foundation subgrade depth during construction. Therefore, subgrade shall be inspected and confirmed ANS Geo's licensed professional engineer prior to constructing footing.

**Figure 3: Bearing Surface Regions**



(Source: Google Earth accessed on August 29, 2023, E&LP Clinton Commons Minor Subdivision Plan December 3, 2020)

Assuming each of the proposed new buildings' footings will be bearing at a depth of at least four (4) feet BGS on the soil or bedrock as listed below, the following allowable bearing capacities shall be considered in accordance with the 2021 New Jersey Edition of the International Building Code. The recommended Allowable Bearing Capacities are based on a tolerable limit of one inch of total settlement for column footings, one inch of total settlement for wall footings, one-half inch of differential settlement, and our experience with the encountered subsurface conditions on the project site. Due to the coarse nature of the soils observed onsite in Region 1 and Region 2 in Figure 3 below, it is anticipated that the majority of settlement under Townhome Buildings 1, 2, 3, 4, 5, 6, 7, 8, 9, 10, and the retail building will be immediate. Given that the drained and cohesive nature of soils located in Region 3, the majority of the settlement under Townhome building 11, the Food Market and the Gas Station is expected to result from primary consolidation.

**Table 9: Bearing Capacities for Proposed Structures By Bearing Material**

Footing Type	Bearing Stratum	Ultimate Bearing Capacity (psf)	Allowable Bearing Capacity (psf)
<b>Region 1: Townhome Buildings 1, 3, 6, 7, 8, 9, 10</b>			
Strip (Wall) (B = 3 ft, L = 30 ft)	Competent Bedrock	8,000	4,000
Spread (Column) (B = 5 ft, L = 5 ft)			
<b>Region 2: Commercial Restaurant, Townhome Buildings 2, 4, 5</b>			
Strip (Wall) (B = 3 ft, L = 30 ft)	Crushed Stone/ Structural Fill Over Dense Gravels	6,000	2,500
Spread (Column) (B = 5 ft, L = 5 ft)			
<b>Region 3</b>			
<b>Townhome Building 11/Gas Station</b>			
Strip (Wall) (B = 1.5 ft, L = 30 ft)	Crushed Stone/ Structural Fill Over Gravel and Clay	6,000	3,000
Spread (Column) (B = 3 ft, L = 3 ft)		6,000	3,000
<b>Food Market</b>			
Strip (Wall) (B = 1.5 ft, L = 30 ft)	Crushed Stone/ Structural Fill Over Gravel and Clay	6,000	3,000
Spread (Column) (B = 3 ft, L = 3 ft)		6,000	3,000
Mat Footing (150 ft by 150 ft)		1,000	750

**ANS Geo recommends selecting an Allowable Bearing Capacity per Table 9 for each structure supported by shallow foundations bearing on corresponding surfaces or crushed stone or structural fill to avoid any excessive differential settlement.**

Based on our interpretation of the subsurface conditions observed during each of our investigation programs, ANS Geo recommends that the geotechnical design parameters, as depicted in Table 10, be considered for this project site including the design of proposed retaining walls.

**Table 10: Geotechnical Design Parameters**

Depth* (feet)	Material	Total Unit Weight (lb/ft <sup>3</sup> )	Effective Unit Weight (lb/ft <sup>3</sup> )	Internal Friction Angle	Cohesion (lb/ft <sup>2</sup> )	Modulus of Vertical Subgrade (k) (lb/in <sup>3</sup> )	K <sub>0</sub> (At-rest earth pressure coefficient)	K <sub>a</sub> (Active earth pressure coefficient)	K <sub>p</sub> ** (Passive earth pressure coefficient)
TBD	Structural Fill	130	130	33°	0	115	0.455	0.294	1.70
0' – 4'	Sandy Silt	105	105	27°	0	60	0.546	0.376	1.33
4' – 11'	Silty Gravel	115	115	29°	0	80	0.515	0.347	1.44
11' – 16'	Silty Clay	110	110	0°	900	25	1	1	1
16' – 20'	Weathered Bedrock	125	125	33°	0	80	0.455	0.294	1.70
18'+	Bedrock	170	155	35°	0	160	0.426	0.271	1.85

\*As existing and proposed grades vary throughout the site, these layers are approximate. Silty Clay was not encountered in Region 1-Bedrock or in Region 2-Gravel.

\*\*All passive earth pressure coefficients have been reduced by a safety factor of 2.

## 8.1 Deep Foundation Option for Region 3 - Helical Pile Recommendations

Given that existing subsurface soil at the project site consists of medium stiff clays and silts, ANS Geo has analyzed helical piles as an alternative foundation option. This analysis was performed using DeepFND, a product of DeepEX LLC. Based on borings B-2 and B-16, which were located to be in the footprint of the proposed foodmarket, ANS Geo analyzed a 15-foot-long helical shaft with 2.88 inches in diameter, 0.3 inches in wall thickness, with three 20-inch diameter helical plates of 0.5 inches in thickness, each with 2-foot spacings. This pile has a torque-correlation factor of 5,000 lbs<sup>-1</sup>.

The results of our analysis on helical pile include that the estimated maximum installation torque would be 6.42 kip-feet to support **an unfactored axial load of 15,000 lbs** and **an unfactored lateral load of 2,000 lbs**. The lateral capacity is for lateral deflection less than 1-inch at top of helical pile. If a lateral capacity greater than 2,000 lbs is required, an 8-inch diameter (O.D.) x 0.625-inch-thick steel casing is recommended to be installed from below the foundation to 10 feet BGS. The annulus between the steel casing and helical pile should be grouted with concrete of a minimum compressive strength of 4,000 psi. Using this configuration will allow the lateral capacity to be increased.

Helical piles should have spacing of a minimum of three times the diameter (3D) of the largest helix to minimize group action, which for the proposed helical pile configuration will be 60 inches (3 multiplied by 20 inches). The minimum number of piles required to support a given pile cap or column load should be evaluated and confirmed by the project's Structural Engineer.

## 8.2 Retaining Wall Design

ANS Geo understands that a retaining wall has been proposed to be constructed as part of the development at the project site. At the time of this Report, ANS Geo was provided a drawing and calculation set which was previously submitted by our Client prior to our engagement. This retaining wall design, prepared by others, includes specifications, general notes, a plan view, elevation view, section view external calculations, construction details, and work sheets for an Allan Block Modular Retaining Wall Systems. The previously-submitted drawing set provided by others is included with our report under **Appendix F**. At the request of the Client, the internal and global stability analyses of the retaining wall will be completed by this separate Engineer of Record, and only the allowable bearing capacity is requested by ANS Geo. From ANS Geo's consideration, it recommended that a bearing capacity of 1,000 psf may be used for the foundation of the retaining wall and the retaining wall designer should use recommended geotechnical parameters for the retaining wall design.

# 9 Construction Recommendations

## 9.1 Excavation

Depending on the proposed foundation configurations and the degree of earthwork, excavation will extend deeper than four feet below grade. Excavations deeper than four feet should be shored or sloped and benched unless the excavation is made entirely in stable rock, in accordance with OSHA regulations, for safe working conditions within the excavations. ANS Geo recommends any sloped excavations should be no steeper than 1H:1V (horizontal to vertical) given OSHA's Soil Classification Outline for granular Type B soils. All OSHA soil classifications should be field determined by the contractor's "competent person" prior to excavation. Any proposed shoring systems should be designed by the contractor's "competent person", be certified by a Professional Engineer licensed in the State of New Jersey and should be submitted for review.



It should be noted that weathered bedrock will likely be encountered before competent bedrock. Therefore, The Contractor should be prepared to excavate bedrock to the top of competent bedrock as per a licensed Geotechnical Engineer's approval.

### **9.1.1 Excavation of Rock**

Foundation depths across the site may range from one foot to seven feet BGS, and utilities may be installed as deep as 18 feet BGS including the proposed sewer line near Center Street in the South portion of the site. Previous investigations indicated that rock may be encountered as shallow as at existing grade to three feet BGS within this area; therefore, it is expected that removal of rock will be required to install the foundations as currently proposed. Based on our experience, ANS Geo would expect that rock removal will consist of one of the following methods:

1. Rock hammering: the use of a hydraulic hammer to fracture and break rock into smaller pieces which can then be removed using conventional techniques. This is the initial and primary method which is typically employed first on most rock removal projects.
2. Line-drilling and splitting: the use of small, pre-drilled holes (approximately three-inches in diameter) placed in a grid pattern along the utility corridor where rock is encountered. The drill will typically be extended to two feet below the bottom of proposed excavation, and will create "pre-split" sections of rock which can then be removed using conventional excavation techniques.

However, as mentioned, the method of rock removal will be part of a Contractor's "means-and-methods" determination based on their available equipment, as well as their own experience.

## **9.2 Dewatering**

Though groundwater was not encountered during any of ANS Geo's borings at the project site, the presence of groundwater and surface runoff should be expected during the construction phase of the project. Wet conditions should be prepared for and managed using localized sump-and-pump or similar techniques to allow for concrete foundation construction in-the-dry. The contractor should be sure to grade the surface as necessary to divert stormwater away from any open excavation to the extent possible. To prevent impacting water quality in the nearby Round Brook Stream, a temporary runoff diversion system may need to be designed to allow surface runoff to continue downstream while avoiding potential sediment pollution. Water discharge should be managed in compliance with applicable state and local regulations.

### **9.2.1 Groundwater Runoff Maintenance**

During construction, natural groundwater recharge and discharge rates should be maintained to prevent adverse behaviors of mapped "weathered bedrock Epi-Karst", "preferential drainage conduits", "highly weathered zones", and "deep soil-infilled dissolution pockets". Contractors should adhere to Best Management Practices for Stormwater Pollution Prevention Plans (SWPPP), which may involve installation of double-layered silt fencing and installation of hay bales or coir logs along the edges of construction zones to reduce runoff velocity.

## **9.3 Subgrade Preparation and Compaction**

During the process of forming and pouring of shallow foundations on native soil above the bedrock surface, ANS Geo recommends over-excavating the subgrade by at least twelve (12) inches, lining the exposed material with a geotextile separation fabric, and bringing the subgrade back up to the design foundation elevation with ¾-inch crushed stone or compacted structural fill as specified within Table 11.

**Table 11: Recommended Gradation of Structural Fill**

Sieve Size	Percent Passing
3-inch	100
1 ½-inch	60 – 100
No. 4	30 – 60
No. 200	0 – 10

Native material beneath the separation fabric should be inspected for unsatisfactory conditions such as standing water, frozen soil, organics, protruding cobbles or boulders, or deleterious materials. Should any unsatisfactory conditions exist within the native subgrade, the excavation should be undercut an additional six (6) inches prior to placement of the geotextile fabric. Structural fill material should be placed in loose lifts not exceeding eight (8) inches in height and be compacted to at least 95 percent of its Modified Proctor Density in accordance with ASTM D1557.

For construction of shallow foundations bearing on bedrock, the bedrock subsurface shall be cleaned of all soil debris and free-standing water prior to concrete pouring. Weathered bedrock and any residual soil shall be removed off the bedrock subgrade prior to constructing the foundation formwork. The bedrock subgrade shall be inspected and approved by a Geotechnical Engineer licensed in New Jersey prior to formwork installation.

Since our evaluation is based on the results of our geotechnical investigation and rock unconfined compressive strength determined from laboratory testing of intact rock specimens, ANS Geo recommends that a full-time geotechnical representative from our firm be on-site to monitor rock excavation and preparation activities, and to perform inspection of the proposed foundation subbase and rock surface prior to the construction of formwork of foundations on rock. Should it be determined that field conditions reveal weaker, more jointed or weathered rock than that considered during our evaluation, it may be necessary to remediate the subgrade to accommodate the proposed foundations. This remediation may include, but is not limited to, the installation of rock anchors, removal of additional rock, the use of a mud-mat or compacted, crushed clean stone, or selective removal of jointed and weathered rock to provide a clean, non-yielding surface. In addition, it is possible that during excavation, areas of weathered rock, soil seams or infilling within joints, or residual soil from weathered rock may be encountered at the proposed foundation subgrade level. This material will need to be removed, and the area cleaned, prior to casting of foundations. ANS Geo recommends that this top of rock surface be visually inspected prior to placement and casting of foundations.

Please note, ANS Geo’s evaluation is limited to the structural foundations and does not include the retaining wall, adjacent roadways, or global or local slope stability evaluation. In addition, the goal of our evaluation was to determine the adequacy of the soil and rock to accommodate compression (bearing capacity) loads transmitted from the foundation structures. ANS Geo has not completed structural design to confirm the proposed size, configuration, location, or geometry of each structure, or to determine the adequacy of each footing. Should the design of the structure and foundations change, ANS Geo should be provided the opportunity to review and revise our technical evaluation, as necessary, to reflect current design conditions. In addition, as our technical evaluation has been based on our observations and several assumptions of subsurface conditions, ANS Geo has recommended periodic site visits to confirm and validate our technical evaluation. In the event ANS Geo is not retained to make periodic site visits, our recommendations will be considered invalid and must be re-evaluated without prejudice to the need for mitigation or post-construction remedial measures.



### 9.3.1 Foundation Subgrade Quality Assurance

Within areas of proposed foundations, it is recommended that the topsoil, organic material, fill materials and other miscellaneous debris be removed from the proposed footing areas. Native material beneath the separation fabric should be inspected for unsatisfactory conditions such as standing water, frozen soil, organics, protruding cobbles or boulders, or deleterious materials. Upon excavation to the desired grade based on the foundation type, the exposed subgrade should be proof-rolled, followed by the placement of structural fill.

Given that the project site exists within karst bedrock formation, it is possible that subgrade soils may be observed to be inadequately compacted upon proof-rolling. Should any portion of a footing subgrade not pass the proof-roll, ANS Geo recommends performing a percussion probe, Geoprobe, or similar soil probing technique to a minimum depth of two-times the foundation width below the proposed footing prior to backfilling and construction of the foundation. The intent of this probing in a potentially-soft area is to identify if a soil-filled karst feature may have previously existed beneath the proposed footing. If the soil probe does not indicate the presence of consistently soft soil throughout the probe, if weathered or competent rock is encountered, or the probe does not detect any karst feature, the near-surface soft soil which failed the proof-roll should be undercut and replaced with properly compacted fill materials. The excavation should be undercut a minimum of six inches prior to placement of the geotextile separation fabric and/or crushed stone/structural fill material. If the probed soil contains a potential karst feature, ANS Geo should be contacted to evaluate and provide recommendations for the specific foundation(s) in question.

The final, desired grade will depend on finished elevation and the depth of any subgrade modifications as mentioned throughout this Section 9. An ANS Geo representative or similar independent, experienced geoprofessional should determine the actual depth of soil to be replaced during construction. Surface run-off water should be drained away from the excavations and not be allowed to pond.

### 9.3.2 Helical Pile Installation Recommendations

The installation of the helical piles can be performed using a pile rig or excavator equipped with a torque meter. Helical pile installation does not require water. Due to the variation in soil quality within the pile installation depth across Region 3 as depicted in Figure 3 in Section 8 and in **Appendix A**, the minimum installation torque(s) may not be achieved at the given installation depth(s). If this occurs for any instance of either type of pile, the Contractor may continue installation by adding lengths of to the top of the given helical pile. The design of these additional pile lengths should be confirmed by the project's Structural Engineer. Once the target minimum installation torque is achieved, the excess pile length may be cut to locate the pile head at the desired elevation. Helical pile installation logs shall be maintained by a qualified Geotechnical Engineer on site recording the final torque reading and installation depth.

These helical pile recommendations are based on our understanding of the project subsurface conditions and assumed structural loads. Should existing conditions at the project site differ from what was encountered in ANS Geo completed borings B-01 through B-20, as provided in **Appendix B** and **Appendix G**, ANS Geo should be given the opportunity to review the applicability of the collected information and modify our recommendations, as needed.

### 9.3.3 Retaining Wall Foundation Preparation

Based on preliminary plans of the proposed retaining wall and ANS Geo's previous geotechnical explorations, the wall is expected to bear predominantly on gravel underlain by clay. The Contractor shall be prepared to over excavate, backfill, and compact to bottom of proposed retaining wall if unsuitable material is encountered at the proposed subgrade of retaining wall. Structural fill as indicated in Table 11 should be placed in loose lifts not exceeding six (6) inches in height and be compacted to at least 95 percent of its Modified Proctor Density in accordance with ASTM D1557.

### 9.3.4 Bedrock Strength Reduction Mitigation

Special precautions must be taken by the contractor to ensure that the strength of the Dolomitic Limestone, the primary type of bedrock found within the project site, is not reduced unnecessarily by preventable natural processes. This type of bedrock is prone to advanced weathering when exposed to the atmosphere. Once the bedrock is excavated to the required construction depth, the bedrock must be covered by plastic mats or other forms of air-tight and water-tight protection. These protections must be placed on the bedrock subgrade immediately after a licensed Geotechnical Engineer performs the subgrade inspection for each structure, to prevent a potential reduction in bearing resistance. These protections shall also only be removed for the construction of formwork and shall then only be removed immediately prior to pouring of foundations.

## 9.4 Backfilling and Re-use of Native Soils

The material excavated on-site may be re-used as general fill across the project site, or by an off-site user. It is not ANS Geo's recommendation that soil be disposed at a landfill. To the extent that it is not impacted, at the contractual agreement between the Owner and excavation contractor, the clean, extracted material may be re-used in a manner which is consistent with Section 9.3 of our Geotechnical Recommendations Report or taken off-site to an end-user.

- ANS Geo notes that any native soils with considerable fine-grained content (more than 20 percent) may be difficult to handle, place, and compact without proper moisture conditioning and protection. ANS Geo recommends the following measures to reduce the adverse impacts of moisture-sensitive soils: Positive measures should be implemented and maintained to intercept and direct surface water away from moisture-sensitive subgrade surfaces.
- Subgrade surfaces should be sloped and, as appropriate, seal-rolled to facilitate proper drainage. Surfaces should be properly prepared in anticipation of inclement weather. Moisture should not be allowed to collect on subgrade surfaces.
- To the extent practical, the limits of exposed subgrade soils should be minimized.
- Construction traffic should be limited to properly constructed haul roads.
- Disturbed soils should be removed and replaced with compacted controlled fill material.

In-place moisture content readings should be maintained with two (2) percent wet/dry of the optimum moisture content as determined by the Modified Proctor Test (ASTM D1557). Soils of greater than 20 percent fine-grained content may be re-used across the project area for fill-in landscaped areas as general backfill; however, these soils should not be used under, adjacent or above foundations or load-bearing structures where typically imported structural fill is used. Native material used as backfill for cable trenches should be handled and placed at a moisture content at or above its optimum value to ensure representative thermal properties are maintained.

It should be noted that any boulders or buried objects encountered during excavation shall be removed from the backfill stock to be re-used as structural fill or general backfill. ANS Geo recommends importing a clean granular material with less than 15 percent fine-grained content for use as general backfill. General backfill material should be screened of any cobbles, boulders, and any particles larger than three (3) inches in diameter and should not be used beneath any load-bearing structures. General backfill should be placed in loose lift thicknesses not exceeding 12 inches and be compacted to at least 90 percent of its Modified Proctor Density (ASTM D1557). Soil used as backfill should not be handled when frozen and should be free of excessive moisture, organics, and deleterious material. Removal of all cut material that will not be reused as landscaping fill shall be the responsibility of the contractor.

## 9.5 Recommended Services

It is recommended that ANS Geo be retained to provide continuous observation and geotechnical engineering services during the excavation and foundation construction phases including rock subgrade inspection. The purpose of this is to observe compliance with the design, project specifications and recommendations, and to facilitate design changes in the event that subsurface conditions differ from those anticipated prior to the start of construction.

## 9.6 Karst Mitigation Plan

ANS Geo has performed a thorough geophysical investigation of the potential karstic conditions within the project site and submitted a Phase II Geophysical Investigation Report in compliance with the Carbonate Rock Area article of the Town of Clinton Municipal Codes. However, investigating the entirety of a project site is economically feasible nor industry practice; therefore, it remains a possibility that karstic conditions can be encountered during construction. In the event of karst conditions are encountered during construction, the work should be halted, and the Karst Mitigation Plan, provided as **Attachment H** to this Report, shall come into effect. In addition, the Town of Clinton and the Town Engineer shall be notified immediately. Additional erosion and sedimentation controls per the Karst Mitigation Plan should be implemented to prevent surface water runoff into the encountered karst feature. A geotechnical representative or technical professional familiar with karst terrain should perform an investigation of the karst feature and conduct a detailed evaluation. If deemed necessary, the representative or professional shall develop a specific mitigation plan for the karst feature, to be implemented prior to the resumption of excavation or construction activities.

All contractors whose work will bring them in to contact with soil, bedrock, or large volumes of water onsite—including but not limited to those responsible for excavation, foundation construction, and installation of utilities—should be made to acknowledge the nature of the Carbonate Rock Area of Clinton Municipal Code, what to do if karstic conditions are encountered, the guidelines to follow which will help avoid issues related to karst formations, and the consequences of not adhering to said guidelines. If retained for Geotechnical Construction Oversight and subgrade inspection, ANS Geo will develop guidelines for contractors to observe when working on the project site.

Finally, ANS Geo recommends that a construction monitoring program consisting of survey markers in key potential karst-condition areas shall be placed prior to any construction activities, including the process of cutting soil and rock and filling soil to meet the proposed grading specifications. The purpose of the survey markers would be to establish pre-, during, and post-construction soil movement, if any, and to understand if site activities such as rock removal are de-stabilizing the intact rock, and to determine if remedial measures are necessary. ANS Geo has provided further input in our Karst Management and Mitigation Plan in **Appendix H**.

## 10 Limitations

ANS Geo notes that the findings and recommendations presented within this Geotechnical Recommendations Report are based on our investigation programs conducted in February, May, and September of 2022, and between August 21 and August 23, 2023, and our engineering judgment. Contractors intending to use this report and test boring information may do so at their own risk. Unless specifically indicated to the contrary in this report, this does not address environmental considerations (if any), which may affect development at the project site. Should the scope of the project or proposed site layout change, ANS Geo should be given the opportunity to review the applicability of the collected information and modify our recommendations, as needed.

Note, as discussed, geotechnical investigations and recommendations for the proposed Block Retaining Wall have not been provided in this report. Analysis of this site element may be performed as part of a separate memorandum or report and is not part of the scope of this Geotechnical Recommendations Report.

We sincerely appreciate the opportunity to support this project, and please feel free to contact us should you have any questions regarding the findings of this Report.

## Appendix A

### **Investigation Location Plans And Bearing Surface Region Plan**





Client:

CONCEPT ENGINEERING  
CONSULTANTS, PA

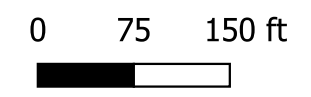
ANS INVESTIGATION  
LOCATION PLAN  
CLINTON COMMONS  
DEVELOPMENT

TOWN OF CLINTON, NEW JERSEY



### Legend

- Boring Locations August 2023 ●
- Boring Locations May 2022, September 2022 ●
- As-Drilled Percussion Probe Locations ●
- As-Completed Geophysics Locations —



**Absolute Scale: 1 inch = 150 feet**  
**Scale at 11" x 17" AS SHOWN**

Prepared by: Anton Luz  
Date: August 24, 2023  
Drawing Number: ILP-2 Rev.0






Client:

CONCEPT ENGINEERING  
CONSULTANTS, PA

AS-DRILLED BORING  
LOCATION PLAN  
CLINTON COMMONS  
DEVELOPMENT

TOWN OF CLINTON, NEW JERSEY

### Legend

Project Boundary 

As-Drilled Borings 

0 75 150 ft



**Absolute Scale: 1 inch = 150 feet**  
**Scale at 11" x 17" AS SHOWN**

Prepared by: Anton Luz  
Date: August 24, 2023  
Drawing Number: BLP-2 Rev.0



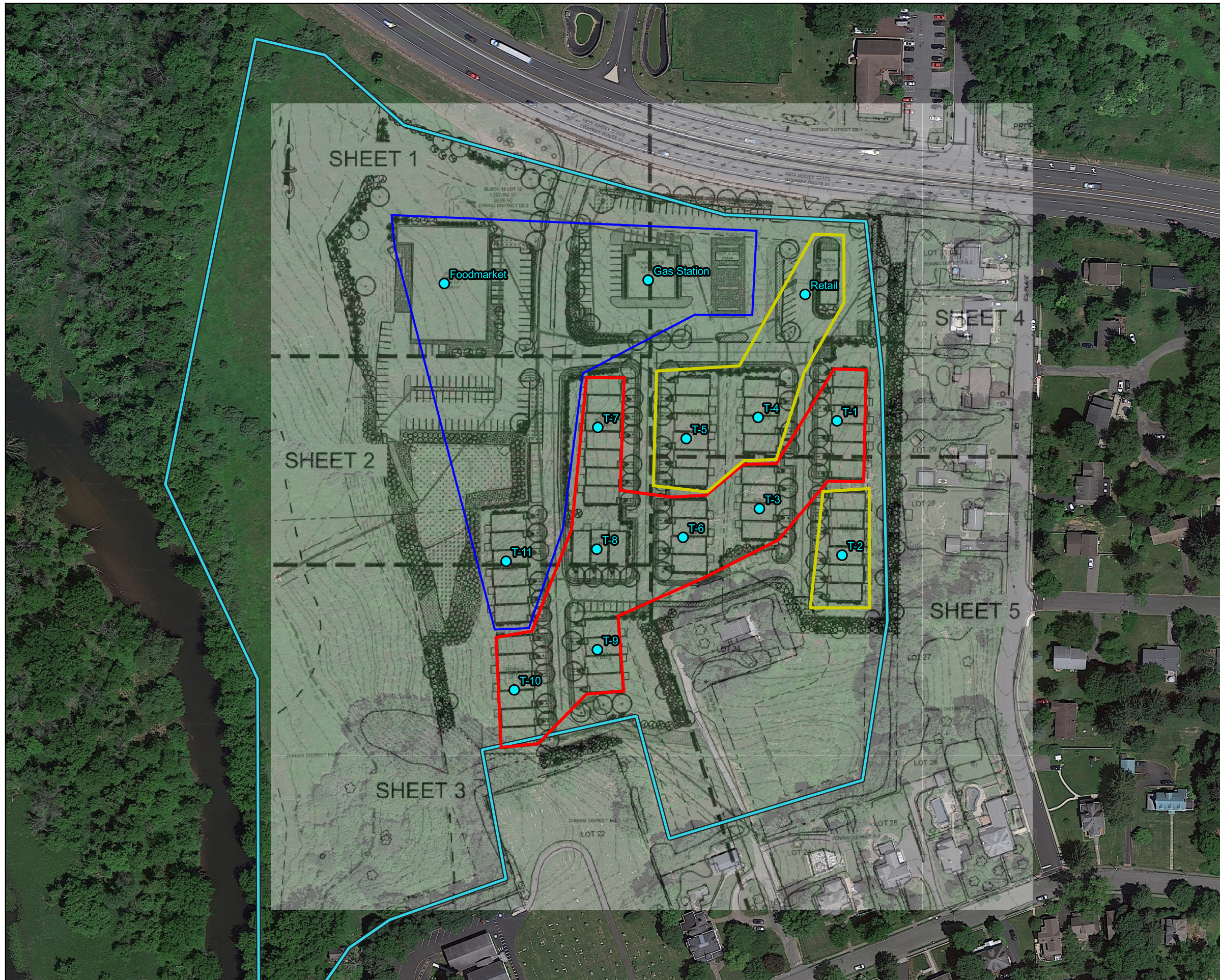


Client:

CONCEPT ENGINEERING  
CONSULTANTS, PA

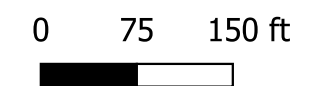
PROPOSED SITE PLAN WITH  
BEARING SURFACE REGIONS  
CLINTON COMMONS  
DEVELOPMENT

TOWN OF CLINTON, NEW JERSEY



**Legend**

- Location of Proposed Structure
- Region 1 - Bearing On Bedrock
- Region 2 - Bearing On Gravel
- Region 3 - Bearing On Gravel And Clay



**Absolute Scale: 1 inch = 150 feet**  
**Scale at 11" x 17" AS SHOWN**

Prepared by: Anton Luz  
Date: August 29, 2023  
Drawing Number: BS-1 Rev.0





Client:

CONCEPT ENGINEERING  
CONSULTANTS, PA

INVESTIGATION LOCATION PLAN  
CLINTON COMMONS  
DEVELOPMENT

TOWN OF CLINTON, NEW JERSEY

### Legend

- As-Completed ANS Geo Soil Boring Location
- ✗ Cancelled Soil Boring Location
- As-Completed Percussion Probe Location
- As Completed E&LP Soil Borings
- As-Completed Geophysics Locations
- Syncline
- Anticline
- Possible Karst Locations
- - - Concealed Fault
- ▶ Thrust Fault

0 130 260 ft



**Absolute Scale: 1 inch = 130 feet**  
**Scale at 11" x 17" AS SHOWN**

Prepared by: Michael Lionikis  
Date: Oct. 07, 2022  
Drawing Number: PIP-1 Rev. 4



## Appendix B

### Test Boring Logs

<b>Client:</b> Concept Engineering Consultants	<b>Drilling Firm:</b> Boring Brothers, Inc	<b>Coordinates:</b> 40.642517 , -74.9076
<b>Project:</b> Clinton Commons	<b>Drill Crew:</b> Matt Daniel / David Osuch / Matt Murtagh	<b>Horiz. Datum:</b> WGS 84
<b>Location:</b> Clinton, NJ	<b>Boring Start:</b> 08/23/23 09:00 AM	<b>Elevation:</b> Grade
<b>Inspector:</b> Anton Luz / Janivel Leo	<b>Boring End:</b> 08/23/23 10:10 AM	<b>Vert. Datum:</b> N/A

<b>Rig Model:</b> CME-55LC	<b>Sampler Type:</b> Split Spoon	<b>Casing Type:</b> Steel
<b>Rig Type:</b> Track	<b>Sampler Length:</b> 24 inches	<b>Casing Length:</b> 20 feet
<b>Drill Method:</b> Mud Rotary	<b>Sampler I.D.:</b> 1.375 inches	<b>Casing I.D.:</b> 4 inches
<b>Hammer Type:</b> Automatic	<b>Hammer Wt.:</b> 140 pounds	<b>Hammer Wt.:</b> 140 pounds
<b>Drilling Fluid:</b> Bentonite	<b>Hammer Fall:</b> 30 inches	<b>Hammer Fall:</b> 30 inches

Depth (ft)	Sample No.	Rec. (ft)	Blows per 6"	N-Value	USCS Symbol	Graphic Log	Visual Classification	Toughness	Plasticity	PP (tsf)	TV (tsf)	N-Value 10 20 30 40	Drilling & Strata Notes
0-2	S-1	15	3 3 16 8	19	SM		Medium dense, Brown to Gray Silty coarse to fine SAND, little coarse to fine Gravel, Moist (SM)						Began boring B-02 S-1, 0-2 feet BGS. Occasional roots encountered.
2-4	S-2	12	14 33 32 13	> 50	SP		Very dense, Brown to Gray coarse to fine SAND, some coarse to fine Gravel, little Silt, Moist (SP)						S-2, 2-4 feet BGS.
4-6	S-3	0	2 3 3 2	6			NO RECOVERY						S-3, 4-6 feet BGS, No Recovery. Installed casing to 4 feet BGS. Drilled to 4 feet BGS. Gray wash with gravel.
6-8	S-4	4	4 4 9 3	13	GM		Medium dense, Brown Silty coarse to fine GRAVEL, trace coarse to fine Sand, Wet (GM)						S-4, 6-8 feet BGS.
8-10	S-5	0	10 5 2 2	7			NO RECOVERY						S-5, 8-10 feet BGS, No Recovery. Installed casing to 8 feet BGS. Drilled to 8 feet BGS. Brown wash.
10-12	S-6	6	2 3 2 5	5	GP		Very loose, Brown to Gray coarse to fine GRAVEL, trace Silt, Wet (GP)						S-6, 10-12 feet BGS. Installed casing to 15 feet BGS. Drilled to 15 feet BGS. Chatter at 11 feet BGS.
15-17	S-7	3	2 1 2 2	3	CL		Soft, Reddish brown CLAY, little coarse to fine Gravel, trace Silt, Wet (CL)	L	M	.8	1		S-7, 15-17 feet BGS. Driller advanced to 20 feet BGS past possible weathered rock material. Installed casing to 20 feet BGS. Drilled to 20 feet BGS. Brown wash.
20							Coring Rock at 20 feet BGS See Rock Coring Log						

In-Borehole Water Levels					General Notes	
Date / Time	Reading Event	Casing Tip (ft)	Bot. of Hole (ft)	Water Lvl (ft)	BGS = Below Ground Surface	
					Ground water not observed.	<b>Toughness:</b> Low (L), Medium (M), High (H) <b>Plasticity:</b> Non-Plastic (NP), Low (L), Medium (M), High (H) <b>PP</b> = Pocket Penetrometer, measured in tons per square ft. <b>TV</b> = Torvane (Shear Vane), measured in tons per square ft. = ATD Water Level (At Time of Drilling) = AD Water Level (After Drilling - Short Term) = EOD Water Level (End of Drilling - Long Term)





# Rock Coring Log

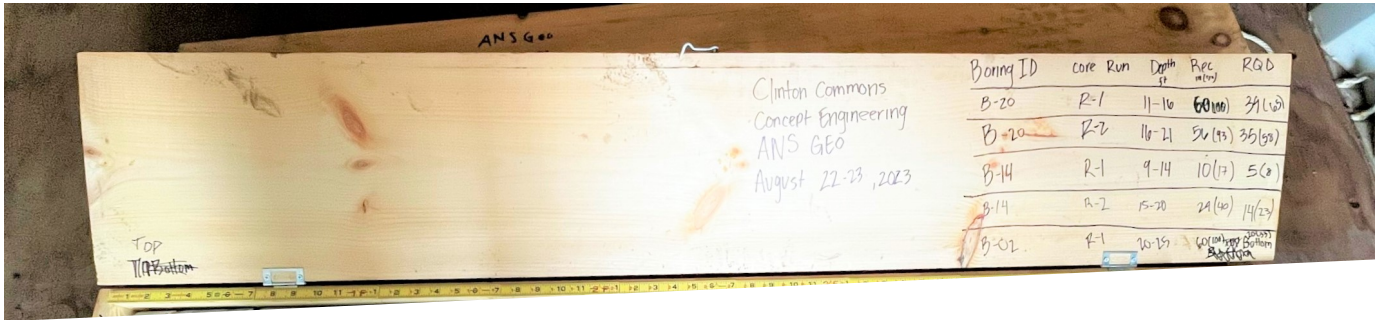
B-02

<b>Client:</b> Concept Engineering Consultants	<b>Drilling Firm:</b> Boring Brothers, Inc	<b>Coordinates:</b> 40.642517 , -74.9076
<b>Project:</b> Clinton Commons	<b>Drill Crew:</b> Matt Daniel / David Osuch / Matt Murtagh	<b>Horiz. Datum:</b> WGS 84
<b>Location:</b> Clinton, NJ	<b>Boring Start:</b> 8/23/2023 9:00:00 AM	<b>Elevation:</b> Grade
<b>Inspector:</b> Anton Luz / Janivel Leo	<b>Boring End:</b> 8/23/2023 10:10:00 AM	<b>Vert. Datum:</b> N/A

<b>Rig Model:</b> CME-55LC	<b>Casing Type:</b> Steel	<b>Core Barrel Type:</b> NQ	<b>Core Bit Type:</b> Diamond
<b>Rig Type:</b> Track	<b>Casing Length:</b> 20 feet	<b>Core Barrel Length:</b> 5 feet	<b>Core Bit Length:</b> 6 inches
<b>Drill Method:</b> Mud Rotary	<b>Casing I.D.:</b> 4 inches	<b>Core Barrel I.D.:</b> 3 inches	<b>Core Bit I.D.:</b> 1.88 inches

Depth (ft)	Avg Core Rate (min/ft)	Run No.	Recovery (in. / %)	RQD (in. / %)	Hardness	Weathering	Graphic Log	Visual Classification	Depth (ft.)	Discontinuities						Drilling & Strata Notes
										Type	Dip Angle	Roughness	Weathering	Aperture	Infilling	
5								LIMESTONE, Gray Medium grain, Slightly weathered, Strong, Partly Open spacing.	20.58	S	0	S,R	DS	PO	L	Began core run R-1 at 20 feet BGS Tan wash 20 to 23 feet BGS  Applied Hydrochloric Acid to Limestone discontinuity, no Effervescent reaction occurred.  Light tan wash 23 to 25 feet BGS
4:09																
4:13	R-1	60	100%	20	R4	SL										
4:22																
5:05										23.66	F	10	S,Sm	DS	DO	
25								End of boring at 25 feet BGS. Backfilled boring to grade with soil cuttings and bentonite chips.								
30																
35																

In-Borehole Water Levels				General Notes	
Date / Time	Casing Tip (ft)	Bot. of Hole (ft)	Water Lvl (ft)	▼ = Water Level (if observed)	BGS = Below Ground Surface
				Ground water not observed.	



**Figure B-02.1**  
B-02; R-1 (Dry)



**Figure B-02.2**  
B-02; R-1 (Wet)



<b>Client:</b> Concept Engineering Consultants	<b>Drilling Firm:</b> Boring Brothers, Inc	<b>Coordinates:</b> 40.642517 , -74.9076
<b>Project:</b> Clinton Commons	<b>Drill Crew:</b> Matt Daniel / David Osuch / Matt Murtagh	<b>Horiz. Datum:</b> WGS 84
<b>Location:</b> Clinton, NJ	<b>Boring Start:</b> 08/22/23 12:20 PM	<b>Elevation:</b> Grade
<b>Inspector:</b> Anton Luz / Janivel Leo	<b>Boring End:</b> 08/23/23 08:50 AM	<b>Vert. Datum:</b> N/A

<b>Rig Model:</b> CME-55LC	<b>Sampler Type:</b> Split Spoon	<b>Casing Type:</b> Steel
<b>Rig Type:</b> Track	<b>Sampler Length:</b> 24 inches	<b>Casing Length:</b> 15 feet
<b>Drill Method:</b> Mud Rotary	<b>Sampler I.D.:</b> 1.375 inches	<b>Casing I.D.:</b> 4 inches
<b>Hammer Type:</b> Automatic	<b>Hammer Wt.:</b> 140 pounds	<b>Hammer Wt.:</b> 140 pounds
<b>Drilling Fluid:</b> Bentonite	<b>Hammer Fall:</b> 30 inches	<b>Hammer Fall:</b> 30 inches

Depth (ft)	Sample No.	Rec. (ft)	Blows per 6"	N-Value	USCS Symbol	Graphic Log	Visual Classification	Toughness	Plasticity	PP (tsf)	TV (tsf)	N-Value 10 20 30 40	Drilling & Strata Notes
0-2	S-1	12	1 5 3 7	8	ML		Medium stiff, Reddish brown Sandy SILT, little coarse to fine Gravel, trace Clay, Moist (ML)	M	M	2	2.5		Began boring B-02 S-1, 0-2 feet BGS. Occasional roots encountered.
2-4	S-2	8	2 5 7 8	12	SM		Medium dense, Yellowish red to Brownish yellow Silty coarse to fine SAND, trace Clay, trace coarse to fine Gravel, moist (SM)	M	M				S-2, 2-4 feet BGS.
4-5	S-3	4	9 6 8 6	14	GM		Medium dense, Yellowish brown Silty coarse to fine GRAVEL, some coarse to fine Sand (GM)	M	M				Installed casing at 4 feet BGS. Drilled to 4 feet BGS. Gray wash at 3 feet BGS. Tan wash at 3.5 feet BGS. Chatter at 3 feet BGS from Rig. S-3, 5-7 feet BGS.
5-7	S-4	15	4 6 9 10	15	SC		Stiff, Brownish yellow coarse to fine SAND, some Clay, little coarse to fine Gravel, trace Silt, Moist (SC)	M	H	-	-		S-4, 7-9 feet BGS. PP and TV testing invalid due to Gravel.
7-9.4	S-5	0	50/5	> 50			NO RECOVERY						S-5, 9-9.4 feet BGS. Refusal and No Recovery. Installed casing to 9 feet BGS. Drilled to 9 feet BGS. Gray to tan wash
9.4-10							BOULDER, Gray Medium grained, Highly weathered, Very strong, Very Closely spaced discontinuities						Continued drilling through possible boulder at 9.4 feet BGS using rock coring bit.
10-15							Coring Rock at 15 feet BGS See Rock Coring Log						Large amount of water loss from 10-14 feet BGS. Core bit advanced to 10 feet BGS over approximately 3 minutes, then suddenly advanced to 13 feet BGS in 25 seconds. Continued drilling to 14 feet BGS. Possible soil-infilled zone beneath boulder.
15-20													Due to water loss drilling resumed on 8/23/23. Drilled through weathered rock from 14 to 15 feet BGS using tricone roller bit.

In-Borehole Water Levels					General Notes	
Date / Time	Reading Event	Casing Tip (ft)	Bot. of Hole (ft)	Water Lvl (ft)	BGS = Below Ground Surface	
					Ground water not observed.	<b>Toughness:</b> Low (L), Medium (M), High (H) <b>Plasticity:</b> Non-Plastic (NP), Low (L), Medium (M), High (H) <b>PP</b> = Pocket Penetrometer, measured in tons per square ft. <b>TV</b> = Torvane (Shear Vane), measured in tons per square ft. = ATD Water Level (At Time of Drilling) = AD Water Level (After Drilling - Short Term) = EOD Water Level (End of Drilling - Long Term)



# Rock Coring Log

B-14

<b>Client:</b> Concept Engineering Consultants	<b>Drilling Firm:</b> Boring Brothers, Inc	<b>Coordinates:</b> 40.642517 , -74.9076
<b>Project:</b> Clinton Commons	<b>Drill Crew:</b> Matt Daniel / David Osuch / Matt Murtagh	<b>Horiz. Datum:</b> WGS 84
<b>Location:</b> Clinton, NJ	<b>Boring Start:</b> 8/22/2023 12:20:00 PM	<b>Elevation:</b> Grade
<b>Inspector:</b> Anton Luz / Janivel Leo	<b>Boring End:</b> 8/23/2023 8:50:00 AM	<b>Vert. Datum:</b> N/A

<b>Rig Model:</b> CME-55LC	<b>Casing Type:</b> Steel	<b>Core Barrel Type:</b> NQ	<b>Core Bit Type:</b> Diamond
<b>Rig Type:</b> Track	<b>Casing Length:</b> 15 feet	<b>Core Barrel Length:</b> 5 feet	<b>Core Bit Length:</b> 6 inches
<b>Drill Method:</b> Mud Rotary	<b>Casing I.D.:</b> 4 inches	<b>Core Barrel I.D.:</b> 3 inches	<b>Core Bit I.D.:</b> 1.88 inches

Depth (ft)	Avg Core Rate (min/ft)	Run No.	Recovery (in. / %)	RQD (in. / %)	Hardness	Weathering	Graphic Log	Visual Classification	Depth (ft.)	Discontinuities						Drilling & Strata Notes
										Type	Dip Angle	Roughness	Weathering	Aperture	Infilling	
1:05								LIMESTONE, Gray Fine grain, Moderately weathered, Very strong, Extremely wide to Open spacing.	15.42	F	0	S,R	DS	EW	FE	Installed casing to 15 feet BGS. Drilled to 15 feet BGS. Began core run R-1 at 15 feet BGS.  Driller used up to 650 gallons throughout core run.  Chatter at 18 feet BGS.
0:30							15.83		S	45	P,Sm	DS	O	QZ		
5:14		R-2	24 40%	14 23%	R5	M										
4:13																
4:04																
20								End of boring at 20 feet BGS. Backfilled boring to grade with soil cuttings and bentonite chips.								
25																
30																

In-Borehole Water Levels				General Notes	
Date / Time	Casing Tip (ft)	Bot. of Hole (ft)	Water Lvl (ft)	▼ = Water Level (if observed)	BGS = Below Ground Surface
				Ground water not observed.	



**Figure B-14.1**  
B-14; R-1 (Dry)



**Figure B-14.2**  
B-14; R-1 (Wet)





**Figure B-14.3**  
B-14; R-2 (Dry)



**Figure B-14.4**  
B-14; R-2 (Wet)

<b>Client:</b> Concept Engineering Consultants	<b>Drilling Firm:</b> Boring Brothers, Inc	<b>Coordinates:</b> 40.642167 , -74.90785
<b>Project:</b> Clinton Commons	<b>Drill Crew:</b> Matt Daniel / David Osuch / Matt Murtagh	<b>Horiz. Datum:</b> WGS 84
<b>Location:</b> Clinton, NJ	<b>Boring Start:</b> 08/23/23 11:30 AM	<b>Elevation:</b> Grade
<b>Inspector:</b> Anton Luz / Janivel Leo	<b>Boring End:</b> 08/23/23 01:50 PM	<b>Vert. Datum:</b> N/A

<b>Rig Model:</b> CME-55LC	<b>Sampler Type:</b> Split Spoon	<b>Casing Type:</b> Steel
<b>Rig Type:</b> Track	<b>Sampler Length:</b> 24 inches	<b>Casing Length:</b> 25 feet
<b>Drill Method:</b> Mud Rotary	<b>Sampler I.D.:</b> 1.375 inches	<b>Casing I.D.:</b> 4 inches
<b>Hammer Type:</b> Automatic	<b>Hammer Wt.:</b> 140 pounds	<b>Hammer Wt.:</b> 140 pounds
<b>Drilling Fluid:</b> Bentonite	<b>Hammer Fall:</b> 30 inches	<b>Hammer Fall:</b> 30 inches

Depth (ft)	Sample No.	Rec. (ft)	Blows per 6"	N-Value	USCS Symbol	Graphic Log	Visual Classification	Toughness	Plasticity	PP (tsf)	TV (tsf)	N-Value 10 20 30 40	Drilling & Strata Notes
0-2	S-1	11	3 3 15 8	18	ML		Very stiff, Brown SILT, some coarse to fine Gravel, little coarse to fine Sand, trace Clay, Moist (ML)	M	H	-	-		Began boring B-16 S-1, 0-2 feet BGS. Occasional roots encountered. PP and TV testing invalid due to Gravel.
2-4	S-2	8	11 7 7 5	14	ML		Stiff, Brownish yellow Gravelly SILT, little coarse to fine Sand, trace Clay, Moist (ML)	M	H	-	-		S-2, 2-4 feet BGS. PP and TV testing invalid due to Gravel.
4-6	S-3	8	4 3 7 6	10	GM		Medium dense, Brown Sandy coarse to fine GRAVEL, some Silt, Moist (GM)					5	S-3, 4-6 feet BGS.
6-8	S-4	4	5 7 5 4	12	GM		Medium dense, Brown Silty coarse to fine GRAVEL, trace Silt, Wet (GM)						S-4, 6-8 feet BGS. Installed casing 6 feet BGS.
8-10	S-5	0	10 10 6 2	16			NO RECOVERY						S-5, 8-10 feet BGS. Installed casing 8 feet BGS. Drilled to 8 feet BGS. Brown wash. Slight Chatter at 9 feet BGS from Rig.
10-12	S-6	2	5 8 10 4	18	GM		Medium dense, Brown Silty coarse to fine GRAVEL, trace coarse to fine Sand, Wet (GM)					10	S-6, 10-12 feet BGS. Occasional roots encountered.
15-17	S-7	6	5 3 3 2	6	CL		Medium Stiff, Brown Silty CLAY, little coarse to fine Gravel, Wet (CL)	L	M	-	-	15	S-7, 15-17 feet BGS. Occasional roots in sample. PP and TV testing invalid due to Gravel. Installed casing 15 feet BGS. Drilled to 15 feet BGS. Brown wash. Slight Chatter at 16 feet BGS from Rig.
20-22	S-8	15	3 4 4 2	8	ML		Medium Stiff, Brown SILT, some coarse to fine Sand, little coarse to fine Gravel, little Clay, Wet (ML)	L	M	-	-	20	S-8, 20-22 feet BGS. PP and TV testing invalid due to Gravel. Installed casing 20 feet BGS. Drilled Brown wash.
23							Chatter at 23 feet BGS. Possible weathered bedrock surface.						

In-Borehole Water Levels				Coring Rock at 25 feet BGS		General Notes	
Date / Time	Reading Event	Casing Tip (ft)	Bot. of Hole (ft)	Water Lvl (ft)	See Rock Coring Log		
						BGS = Below Ground Surface Ground water not observed.	
						<b>Toughness:</b> Low (L), Medium (M), High (H) <b>Plasticity:</b> Non-Plastic (NP), Low (L), Medium (M), High (H) <b>PP</b> = Pocket Penetrometer, measured in tons per square ft. <b>TV</b> = Torvane (Shear Vane), measured in tons per square ft. = ATD Water Level (At Time of Drilling) = AD Water Level (After Drilling - Short Term) = EOD Water Level (End of Drilling - Long Term)	





# Rock Coring Log

B-16

**Client:** Concept Engineering Consultants      **Drilling Firm:** Boring Brothers, Inc      **Coordinates:** 40.642167, -74.90785  
**Project:** Clinton Commons      **Drill Crew:** Matt Daniel / David Osuch / Matt Murtagh      **Horiz. Datum:** WGS 84  
**Location:** Clinton, NJ      **Boring Start:** 8/23/2023 11:30:00 AM      **Elevation:** Grade  
**Inspector:** Anton Luz / Janivel Leo      **Boring End:** 8/23/2023 1:50:00 PM      **Vert. Datum:** N/A

**Rig Model:** CME-55LC      **Casing Type:** Steel      **Core Barrel Type:** NQ      **Core Bit Type:** Diamond  
**Rig Type:** Track      **Casing Length:** 25 feet      **Core Barrel Length:** 5 feet      **Core Bit Length:** 6 inches  
**Drill Method:** Mud Rotary      **Casing I.D.:** 4 inches      **Core Barrel I.D.:** 3 inches      **Core Bit I.D.:** 1.88 inches

Depth (ft)	Avg Core Rate (min/ft)	Run No.	Recovery (in. / %)	RQD (in. / %)	Hardness	Weathering	Graphic Log	Visual Classification	Depth (ft.)	Discontinuities						Drilling & Strata Notes
										Type	Dip Angle	Roughness	Weathering	Aperture	Infilling	
4:50								LIMESTONE, Gray Medium fine grain, Strong, Very wide to Partly open spacing.	25.6	SZ	15	S,Sm	DS	O	ML	Drilling Brown wash  Severe water loss.
3:17							27		F	0	S,R	DS	VW	QZ		
4:14	R-1	54 90%	22 37%	R4	M		27.7		J	10	S,R	DS	PO	DO		
4:35							28.2		J	0	S,R	DS	VW	ML		
3:59							28.9		F	70	S,Sm	DS		DO		
30																
							End of boring at 30 feet BGS. Backfilled boring to grade with soil cuttings and bentonite chips.									
35																
40																

In-Borehole Water Levels				General Notes	
Date / Time	Casing Tip (ft)	Bot. of Hole (ft)	Water Lvl (ft)	▼ = Water Level (if observed)	BGS = Below Ground Surface
				Ground water not observed.	



**Figure B-16.1**  
B-16; R-1 (Dry)



**Figure B-16.2**  
B-16; R-1 (Wet)

<b>Client:</b> Concept Engineering Consultants	<b>Drilling Firm:</b> Boring Brothers, Inc	<b>Coordinates:</b> 40.6418 , -74.90545
<b>Project:</b> Clinton Commons	<b>Drill Crew:</b> Matt Daniel / David Osuch	<b>Horiz. Datum:</b> WGS 84
<b>Location:</b> Clinton, NJ	<b>Boring Start:</b> 08/21/23 08:05 AM	<b>Elevation:</b> Grade
<b>Inspector:</b> Anton Luz / Janivel Leo	<b>Boring End:</b> 08/21/23 10:30 AM	<b>Vert. Datum:</b> N/A

<b>Rig Model:</b> CME-55LC	<b>Sampler Type:</b> Split Spoon	<b>Casing Type:</b> Steel
<b>Rig Type:</b> Track	<b>Sampler Length:</b> 24 inches	<b>Casing Length:</b> 7 feet
<b>Drill Method:</b> Mud Rotary	<b>Sampler I.D.:</b> 1.375 inches	<b>Casing I.D.:</b> 4 inches
<b>Hammer Type:</b> Automatic	<b>Hammer Wt.:</b> 140 pounds	<b>Hammer Wt.:</b> 140 pounds
<b>Drilling Fluid:</b> Bentonite	<b>Hammer Fall:</b> 30 inches	<b>Hammer Fall:</b> 30 inches

Depth (ft)	Sample No.	Rec. (ft)	Blows per 6"	N-Value	USCS Symbol	Graphic Log	Visual Classification	Toughness	Plasticity	PP (tsf)	TV (tsf)	N-Value				Drilling & Strata Notes
												10	20	30	40	
0-1	S-1	12	3 6 24 40	30	SM		Dense, Gray coarse to fine SAND, some Silt, little coarse to fine Gravel, Moist (SM)									Ground Surface covered in brush 1 to 4 feet high. Driller used Track Rig to flatten brush. Began boring B-17 at 8:05 AM S-1, 0-2 feet BGS. Occasional roots encountered. S-2, 2-3' 11" BGS. Refusal encountered on possible cobbles.  S-3, 5-6 feet BGS. Installed casing to 5 feet BGS. Drilled to 5 feet BGS. Light chatter at 4.5 feet. Gray to clear wash. Refusal at 6 feet BGS. Drilled to 7 feet BGS.
1-2	S-2	18	23 6 10 50/5	16			Medium Dense, Gray Gravelly coarse to fine SAND, some Silt, Moist (SM)									
4-5	S-3	3	16 70/6	> 50			Very Dense, Silty coarse to fine SAND, trace fine Gravel, Moist (SM)									
5-6	S-4	0	80/2	> 50												
7	Coring Rock at 7 feet BGS See Rock Coring Log															

In-Borehole Water Levels					General Notes	
Date / Time	Reading Event	Casing Tip (ft)	Bot. of Hole (ft)	Water Lvl (ft)	<b>BGS = Below Ground Surface</b> Ground water not observed.	



# Rock Coring Log

B-17

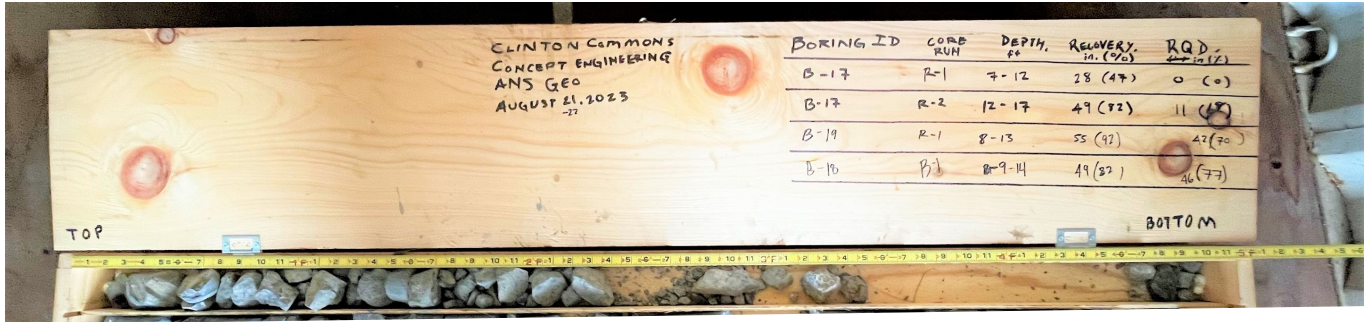
<b>Client:</b> Concept Engineering Consultants	<b>Drilling Firm:</b> Boring Brothers, Inc	<b>Coordinates:</b> 40.6418 , -74.90545
<b>Project:</b> Clinton Commons	<b>Drill Crew:</b> Matt Daniel / David Osuch	<b>Horiz. Datum:</b> WGS 84
<b>Location:</b> Clinton, NJ	<b>Boring Start:</b> 8/21/2023 8:05:00 AM	<b>Elevation:</b> Grade
<b>Inspector:</b> Anton Luz / Janivel Leo	<b>Boring End:</b> 8/21/2023 10:30:00 AM	<b>Vert. Datum:</b> N/A

<b>Rig Model:</b> CME-55LC	<b>Casing Type:</b> Steel	<b>Core Barrel Type:</b> NQ	<b>Core Bit Type:</b> Diamond
<b>Rig Type:</b> Track	<b>Casing Length:</b> 7 feet	<b>Core Barrel Length:</b> 5 feet	<b>Core Bit Length:</b> 6 inches
<b>Drill Method:</b> Mud Rotary	<b>Casing I.D.:</b> 4 inches	<b>Core Barrel I.D.:</b> 3 inches	<b>Core Bit I.D.:</b> 1.88 inches

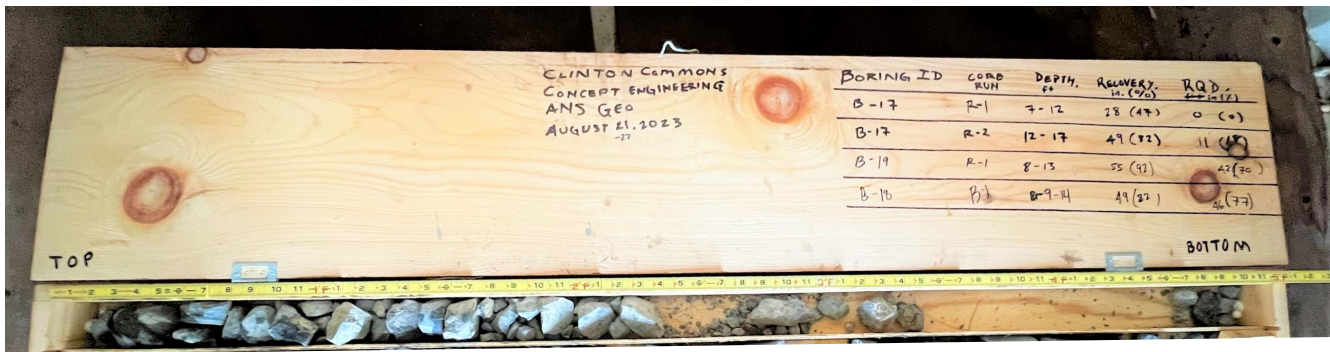
Depth (ft)	Avg Core Rate (min/ft)	Run No.	Recovery (in. / %)	RQD (in. / %)	Hardness	Weathering	Graphic Log	Visual Classification	Depth (ft.)	Discontinuities						Drilling & Strata Notes
										Type	Dip Angle	Roughness	Weathering	Aperture	Infilling	
7:10								LIMESTONE, Gray-Blue Medium fine grain, Highly weathered, Strong							Began Rock Core R-1 at 7 feet BGS. Moderate water loss, Tan wash 7-11.5'	
4:35																
8:20		R-1	28 47%	0 0%	R4	H										
4:10																
4:10																
3:05								LIMESTONE, Gray-Blue Medium fine grain, Highly weathered, Strong, Partly open spacing.							Gray wash 11.5-12 feet BGS. R-2, 12-17 feet BGS. Moderate water loss	
3:15																
3:40		R-2	49 82%	11 18%	R4	SL			14	J	45	P,Sm	DS	PO		DO
4:05									15	J	70	P,Sm	DS	PO		DO
6:27																
								End of boring at 17 feet BGS. Backfilled boring to grade with soil cuttings and bentonite chips.							Applied Hydrochloric Acid to Limestone discontinuity. Effervescent reaction occurred.	
20																
25																

In-Borehole Water Levels				General Notes	
Date / Time	Casing Tip (ft)	Bot. of Hole (ft)	Water Lvl (ft)	▼ = Water Level (if observed)	BGS = Below Ground Surface
				Ground water not observed.	



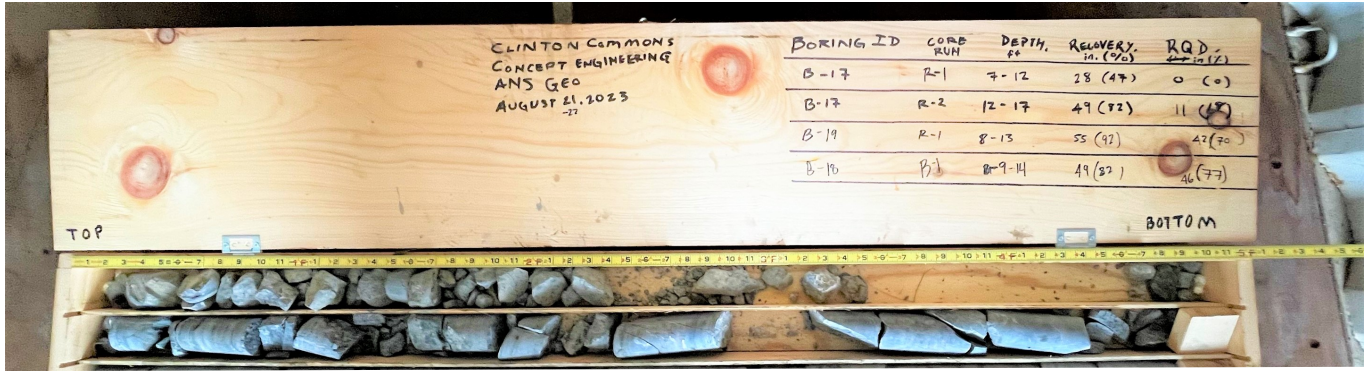


**Figure B-17.1**  
B-17; R-1 (Dry)

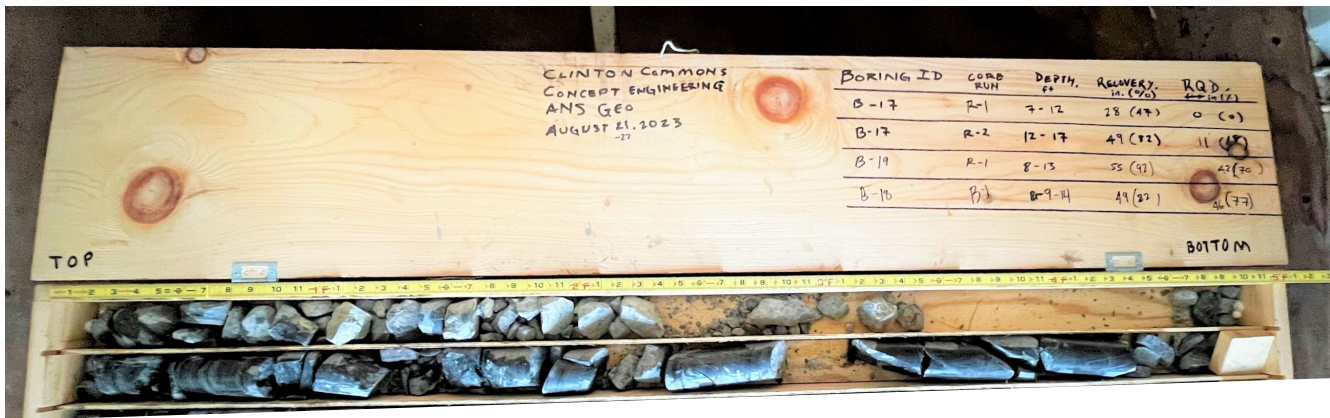


**Figure B-17.2**  
B-17; R-1 (Wet)





**Figure B-17.3**  
B-17; R-2 (Dry)



**Figure B-017.4**  
B-17; R-2 (Wet)



# Soil Boring Log

**B-18**

<b>Client:</b> Concept Engineering Consultants	<b>Drilling Firm:</b> Boring Brothers, Inc	<b>Coordinates:</b> 40.641083 , -74.905533
<b>Project:</b> Clinton Commons	<b>Drill Crew:</b> Matt Daniel / David Osuch / Matt Murtagh	<b>Horiz. Datum:</b> WGS 84
<b>Location:</b> Clinton, NJ	<b>Boring Start:</b> 08/21/23 12:50 PM	<b>Elevation:</b> Grade
<b>Inspector:</b> Anton Luz / Janivel Leo	<b>Boring End:</b> 08/22/23 09:30 AM	<b>Vert. Datum:</b> N/A

<b>Rig Model:</b> CME-55LC	<b>Sampler Type:</b> Split Spoon	<b>Casing Type:</b> Steel
<b>Rig Type:</b> Track	<b>Sampler Length:</b> 24 inches	<b>Casing Length:</b> 9 feet
<b>Drill Method:</b> Mud Rotary	<b>Sampler I.D.:</b> 1.375 inches	<b>Casing I.D.:</b> 4 inches
<b>Hammer Type:</b> Automatic	<b>Hammer Wt.:</b> 140 pounds	<b>Hammer Wt.:</b> 140 pounds
<b>Drilling Fluid:</b> Bentonite	<b>Hammer Fall:</b> 30 inches	<b>Hammer Fall:</b> 30 inches

Depth (ft)	Sample No.	Rec. (ft)	Blows per 6"	N-Value	USCS Symbol	Graphic Log	Visual Classification	Toughness	Plasticity	PP (tsf)	TV (tsf)	N-Value				Drilling & Strata Notes
												10	20	30	40	
0-2	S-1	14	1 2 2 5	4	ML		Soft, Reddish brown Clayey SILT, trace coarse to fine Sand, trace coarse to fine Gravel, Moist (ML)	M	M	1.5	2					Began boring S-1, 0-2' at 12:50 PM. Occasional roots.
2-4	S-2	13	4 5 11 14	16	CL		Top 7": Reddish brown to Brown Silty CLAY, trace coarse to fine Sand, Moist (CL)									S-2, 2-4 feet BGS.
4-6					GP		Bottom 6": Brown Sandy coarse to fine GRAVEL, trace Clay, Moist (GP)									Decomposed rock encountered.
6-8	S-3	14	32 34 43 32	77	SM		Very Dense, Dark Brown to Brown Gravelly coarse to fine SAND, little Silt, little Clay, Moist (SM)									S-3, 4-6 feet BGS. Installed casing at 4 feet BGS. Drilled to 4 feet BGS; casing spinning.
8-10	S-4	2	9 70/5	> 50	SM		Dark Brown Gravelly coarse to fine SAND, some Silt, Wet (SM)									S-4, 6-8 feet BGS. Drilled 6 feet BGS. Chatter at 6 feet BGS from Rig.
10-9							Coring Rock at 9 feet BGS See Rock Coring Log									Drilled to 9 feet BGS.

In-Borehole Water Levels					General Notes	
Date / Time	Reading Event	Casing Tip (ft)	Bot. of Hole (ft)	Water Lvl (ft)		
					BGS = Below Ground Surface Ground water not observed.	
					<b>Toughness:</b> Low (L), Medium (M), High (H) <b>Plasticity:</b> Non-Plastic (NP), Low (L), Medium (M), High (H) <b>PP</b> = Pocket Penetrometer, measured in tons per square ft. <b>TV</b> = Torvane (Shear Vane), measured in tons per square ft. = ATD Water Level (At Time of Drilling) = AD Water Level (After Drilling - Short Term) = EOD Water Level (End of Drilling - Long Term)	



# Rock Coring Log

B-18

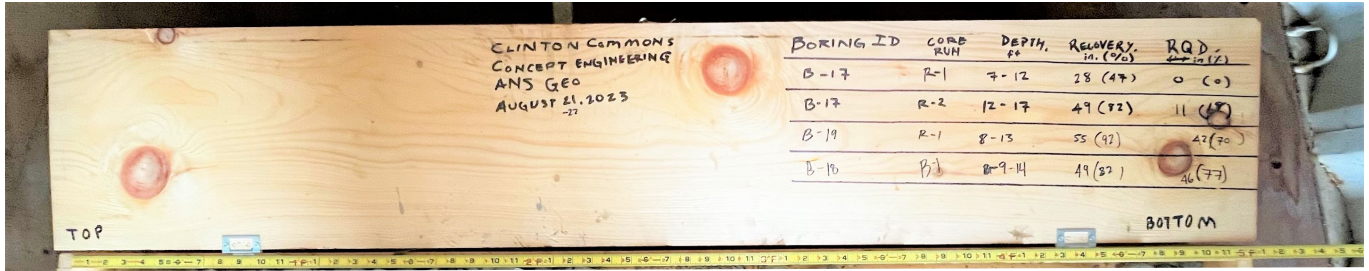
<b>Client:</b> Concept Engineering Consultants	<b>Drilling Firm:</b> Boring Brothers, Inc	<b>Coordinates:</b> 40.641083 , -74.905533
<b>Project:</b> Clinton Commons	<b>Drill Crew:</b> Matt Daniel / David Osuch / Matt Murtagh	<b>Horiz. Datum:</b> WGS 84
<b>Location:</b> Clinton, NJ	<b>Boring Start:</b> 8/21/2023 12:50:00 PM	<b>Elevation:</b> Grade
<b>Inspector:</b> Anton Luz / Janivel Leo	<b>Boring End:</b> 8/22/2023 9:30:00 AM	<b>Vert. Datum:</b> N/A

<b>Rig Model:</b> CME-55LC	<b>Casing Type:</b> Steel	<b>Core Barrel Type:</b> NQ	<b>Core Bit Type:</b> Diamond
<b>Rig Type:</b> Track	<b>Casing Length:</b> 9 feet	<b>Core Barrel Length:</b> 5 feet	<b>Core Bit Length:</b> 6 inches
<b>Drill Method:</b> Mud Rotary	<b>Casing I.D.:</b> 4 inches	<b>Core Barrel I.D.:</b> 3 inches	<b>Core Bit I.D.:</b> 1.88 inches

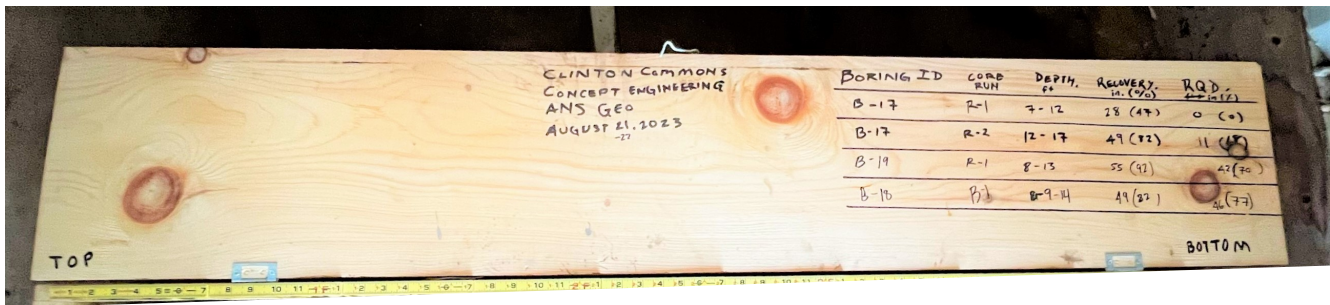
Depth (ft)	Avg Core Rate (min/ft)	Run No.	Recovery (in. / %)	RQD (in. / %)	Hardness	Weathering	Graphic Log	Visual Classification	Depth (ft.)	Discontinuities						Drilling & Strata Notes
										Type	Dip Angle	Roughness	Weathering	Aperture	Infilling	
10	7:36							LIMESTONE, Gray Medium to Fine grain, Fresh, Very Strong, Tight spacing.	9.8	J	50	P,Sm	FR	T	DO	Began coring at 9 feet BGS at 8:26 AM. Tan wash.  Light tan to white wash.  Gray wash.
	5:58						10		S	10	S,R	DS	FE			
	6:27	R-1	49 82%	46 77%	R5	FR										
	5:21															
	7:06															
15								End of boring at 14 feet BGS. Backfilled boring to grade with soil cuttings and bentonite chips.								
20																
25																

In-Borehole Water Levels				General Notes	
Date / Time	Casing Tip (ft)	Bot. of Hole (ft)	Water Lvl (ft)		
				▼ = Water Level (if observed)      BGS = Below Ground Surface Ground water not observed.	





**Figure B-18.1**  
B-18; R-1 (Dry)



**Figure B-18.2**  
B-18; R-1 (Wet)

<b>Client:</b> Concept Engineering Consultants	<b>Drilling Firm:</b> Boring Brothers, Inc	<b>Coordinates:</b> 40.641667, -74.906367
<b>Project:</b> Clinton Commons	<b>Drill Crew:</b> Matt Daniel / David Osuch	<b>Horiz. Datum:</b> WGS 84
<b>Location:</b> Clinton, NJ	<b>Boring Start:</b> 08/21/23 11:00 AM	<b>Elevation:</b> Grade
<b>Inspector:</b> Anton Luz / Janivel Leo	<b>Boring End:</b> 08/21/23 12:30 PM	<b>Vert. Datum:</b> N/A

<b>Rig Model:</b> CME-55LC	<b>Sampler Type:</b> Split Spoon	<b>Casing Type:</b> Steel
<b>Rig Type:</b> Track	<b>Sampler Length:</b> 24 inches	<b>Casing Length:</b> 8 feet
<b>Drill Method:</b> Mud Rotary	<b>Sampler I.D.:</b> 1.375 inches	<b>Casing I.D.:</b> 4 inches
<b>Hammer Type:</b> Automatic	<b>Hammer Wt.:</b> 140 pounds	<b>Hammer Wt.:</b> 140 pounds
<b>Drilling Fluid:</b> Bentonite	<b>Hammer Fall:</b> 30 inches	<b>Hammer Fall:</b> 30 inches

Depth (ft)	Sample No.	Rec. (ft)	Blows per 6"	N-Value	USCS Symbol	Graphic Log	Visual Classification	Toughness	Plasticity	PP (tsf)	TV (tsf)	N-Value				Drilling & Strata Notes
												10	20	30	40	
5	S-1	15	8 7 10 6	17	ML		Top 8": Reddish brown Sandy SILT, trace Clay, Moist (ML)									Began boring at B-19 at 11:00 AM S-1, 0-2 feet BGS. Some organic; Brush from 1 to 4 feet tall.  S-2 2-4'; Refusal at 3.5 feet BGS.  S-3, 5-7 feet BGS. Installed casing at 5 feet BGS. Drilled Gray wash. Refusal at 5'2" BGS.  S-4, 7-7.5 feet BGS. Refusal at 7.5 feet BGS
					SP		Bottom 7": Gray coarse to fine SAND, little coarse to fine Gravel, trace Silt, Moist (SP)									
	S-2	15	10 16 67/6"	> 50	SM		Very Dense, Gray Silty coarse to fine SAND, some coarse to fine Gravel, Moist (SM)									
						GC		Gray Clayey coarse to fine GRAVEL, some coarse to fine Sand, Moist (GC)								
	S-3	2	50/5	> 50	GC		Gray to Brown Clayey coarse to fine GRAVEL, trace Sand, Moist (GC)									
	S-4	2	50/2	> 50			Gray to Brown Clayey coarse to fine GRAVEL, trace Sand, Moist (GC)									
							Coring Rock at 8 feet BGS See Rock Coring Log									

In-Borehole Water Levels					General Notes	
Date / Time	Reading Event	Casing Tip (ft)	Bot. of Hole (ft)	Water Lvl (ft)	BGS = Below Ground Surface	
					Ground water not observed.	

**Toughness:** Low (L), Medium (M), High (H)  
**Plasticity:** Non-Plastic (NP), Low (L), Medium (M), High (H)  
**PP** = Pocket Penetrometer, measured in tons per square ft.  
**TV** = Torvane (Shear Vane), measured in tons per square ft.

= ATD Water Level (At Time of Drilling)  
 = AD Water Level (After Drilling - Short Term)  
 = EOD Water Level (End of Drilling - Long Term)



# Rock Coring Log

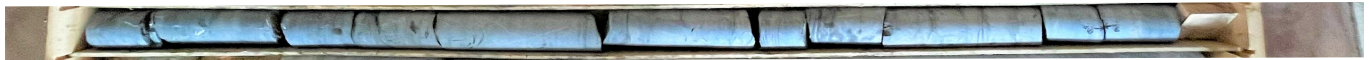
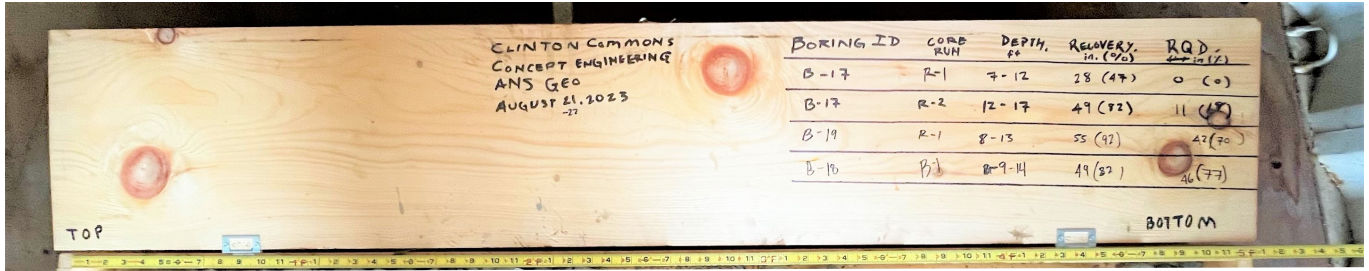
B-19

<b>Client:</b> Concept Engineering Consultants	<b>Drilling Firm:</b> Boring Brothers, Inc	<b>Coordinates:</b> 40.641667 , -74.906367
<b>Project:</b> Clinton Commons	<b>Drill Crew:</b> Matt Daniel / David Osuch	<b>Horiz. Datum:</b> WGS 84
<b>Location:</b> Clinton, NJ	<b>Boring Start:</b> 8/21/2023 11:00:00 AM	<b>Elevation:</b> Grade
<b>Inspector:</b> Anton Luz / Janivel Leo	<b>Boring End:</b> 8/21/2023 12:30:00 PM	<b>Vert. Datum:</b> N/A

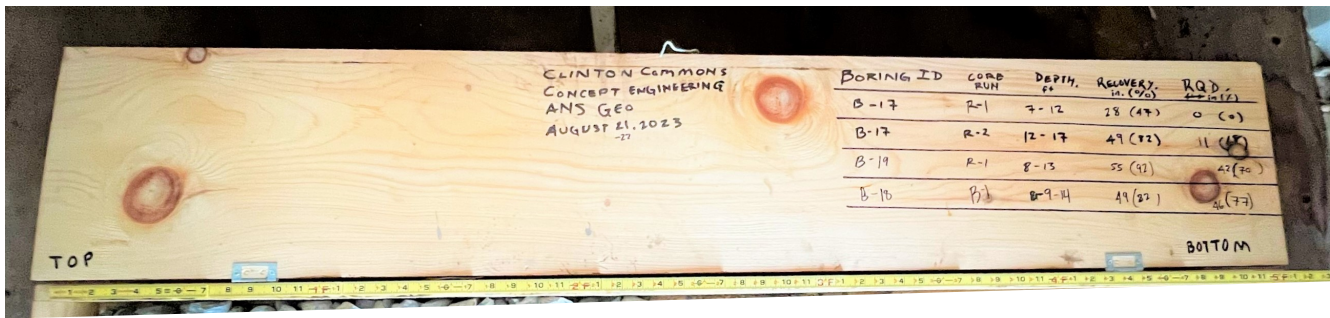
<b>Rig Model:</b> CME-55LC	<b>Casing Type:</b> Steel	<b>Core Barrel Type:</b> NQ	<b>Core Bit Type:</b> Diamond
<b>Rig Type:</b> Track	<b>Casing Length:</b> 8 feet	<b>Core Barrel Length:</b> 5 feet	<b>Core Bit Length:</b> 6 inches
<b>Drill Method:</b> Mud Rotary	<b>Casing I.D.:</b> 4 inches	<b>Core Barrel I.D.:</b> 3 inches	<b>Core Bit I.D.:</b> 1.88 inches

Depth (ft)	Avg Core Rate (min/ft)	Run No.	Recovery (in. / %)	RQD (in. / %)	Hardness	Weathering	Graphic Log	Visual Classification	Depth (ft.)	Discontinuities						Drilling & Strata Notes
										Type	Dip Angle	Roughness	Weathering	Aperture	Infilling	
10	3:40	R-1	55 92%	42 70%	R4	SL		LIMESTONE, Gray Fine grain, Slightly weathered, Strong, Wide to Tight spacing.	8.5	F	25	S,R	DS	W	FE	Began coring at 11:35 AM; Gray wash.
	9.25								S	20	U,Sm	DS	T	DO		
	9.58								S	15	S,Sm	DS	MW	DO		
	10								S	30	S,Sm	DS	MW	DO		
	3:29														11.5	
	3:11							12.2	J	15	P,Sm	DS		FE		
15	3:51							End of boring at 13 feet BGS. Backfilled boring to grade with soil cuttings and bentonite chips.								

In-Borehole Water Levels				General Notes	
Date / Time	Casing Tip (ft)	Bot. of Hole (ft)	Water Lvl (ft)	▼ = Water Level (if observed)	BGS = Below Ground Surface
				Ground water not observed.	



**Figure B-19.1**  
B-19; R-1 (Dry)



**Figure B-19.2**  
B-19; R-2 (Wet)



<b>Client:</b> Concept Engineering Consultants	<b>Drilling Firm:</b> Boring Brothers, Inc	<b>Coordinates:</b> 40.64255 , -74.907567
<b>Project:</b> Clinton Commons	<b>Drill Crew:</b> Matt Daniel / David Osuch / Matt Murtagh	<b>Horiz. Datum:</b> WGS 84
<b>Location:</b> Clinton, NJ	<b>Boring Start:</b> 08/22/23 09:47 AM	<b>Elevation:</b> Grade
<b>Inspector:</b> Anton Luz / Janivel Leo	<b>Boring End:</b> 08/22/23 10:30 AM	<b>Vert. Datum:</b> N/A

<b>Rig Model:</b> CME-55LC	<b>Sampler Type:</b> Split Spoon	<b>Casing Type:</b> Steel
<b>Rig Type:</b> Track	<b>Sampler Length:</b> 24 inches	<b>Casing Length:</b> 8 feet
<b>Drill Method:</b> Mud Rotary	<b>Sampler I.D.:</b> 1.375 inches	<b>Casing I.D.:</b> 4 inches
<b>Hammer Type:</b> Automatic	<b>Hammer Wt.:</b> 140 pounds	<b>Hammer Wt.:</b> 140 pounds
<b>Drilling Fluid:</b> Bentonite	<b>Hammer Fall:</b> 30 inches	<b>Hammer Fall:</b> 30 inches

Depth (ft)	Sample No.	Rec. (ft)	Blows per 6"	N-Value	USCS Symbol	Graphic Log	Visual Classification	Toughness	Plasticity	PP (tsf)	TV (tsf)	N-Value				Drilling & Strata Notes	
												10	20	30	40		
	S-1	14	4 13 27 31	40	ML		Hard, Brown coarse to fine Sandy SILT, some coarse to fine Gravel, Moist (ML)									Began boring S-1, 0-2' at 9:47 AM	
	S-2	8	32 96/5	> 50	SM		Very dense, Light Brown Silty coarse to fine SAND, some coarse to fine Gravel, Moist (SM)									S-2, 2-3.5 feet BGS. Sharp sound at 3 feet BGS from Rig. Installed casing at 3.5 feet BGS. Drilled Gray wash.	
5	S-3	5	32 68/6	> 50			Very dense, Gray to Light Brown Silty coarse to fine SAND, little coarse to fine Gravel, Moist (SM)										S-3, 5-7 feet BGS. Light Chatter at 6 feet BGS from Rig. No advancement of spoon. Drilled 7 feet BGS. Tan wash.
	S-4	5	50/5	> 50			Very dense, Gray to Light Brown Silty coarse to fine SAND, little coarse to fine Gravel, Wet (SM)										S-4, 7-9 feet BGS.
10	S-5	4	85/2	> 50	ML		Very dense, Gray Sandy SILT, some coarse to fine Gravel, Wet (SM)									S-5, 9-9.2 feet BGS. Drilled to 11 feet BGS. Tan wash. Chatter at 10.5-11 feet BGS.	
							Coring Rock at 11 feet BGS See Rock Coring Log										

In-Borehole Water Levels					General Notes	
Date / Time	Reading Event	Casing Tip (ft)	Bot. of Hole (ft)	Water Lvl (ft)	BGS = Below Ground Surface	
					Ground water not observed.	

**Toughness:** Low (L), Medium (M), High (H)  
**Plasticity:** Non-Plastic (NP), Low (L), Medium (M), High (H)  
**PP** = Pocket Penetrometer, measured in tons per square ft.  
**TV** = Torvane (Shear Vane), measured in tons per square ft.  
 = ATD Water Level (At Time of Drilling)  
 = AD Water Level (After Drilling - Short Term)  
 = EOD Water Level (End of Drilling - Long Term)



# Rock Coring Log

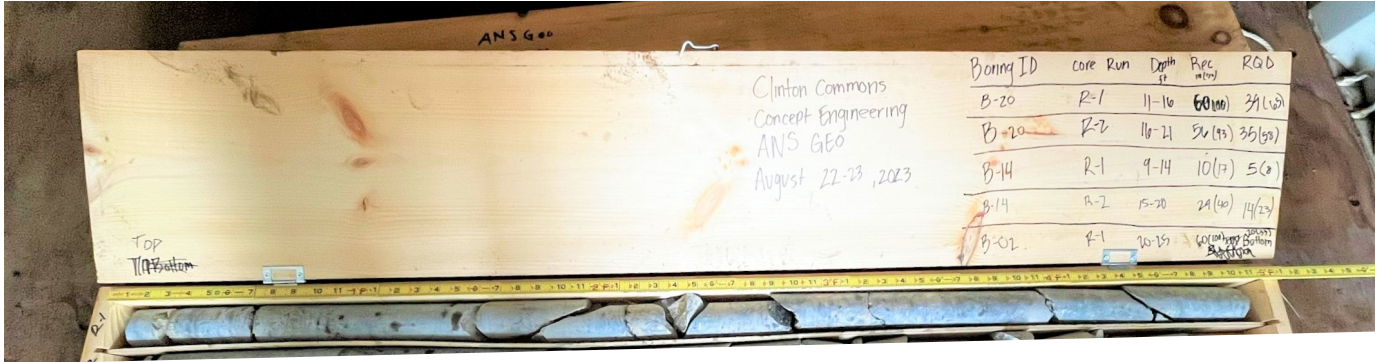
B-20

**Client:** Concept Engineering Consultants      **Drilling Firm:** Boring Brothers, Inc      **Coordinates:** 40.64255 , -74.907567  
**Project:** Clinton Commons      **Drill Crew:** Matt Daniel / David Osuch / Matt Murtagh      **Horiz. Datum:** WGS 84  
**Location:** Clinton, NJ      **Boring Start:** 8/22/2023 9:47:00 AM      **Elevation:** Grade  
**Inspector:** Anton Luz / Janivel Leo      **Boring End:** 8/22/2023 10:30:00 AM      **Vert. Datum:** N/A

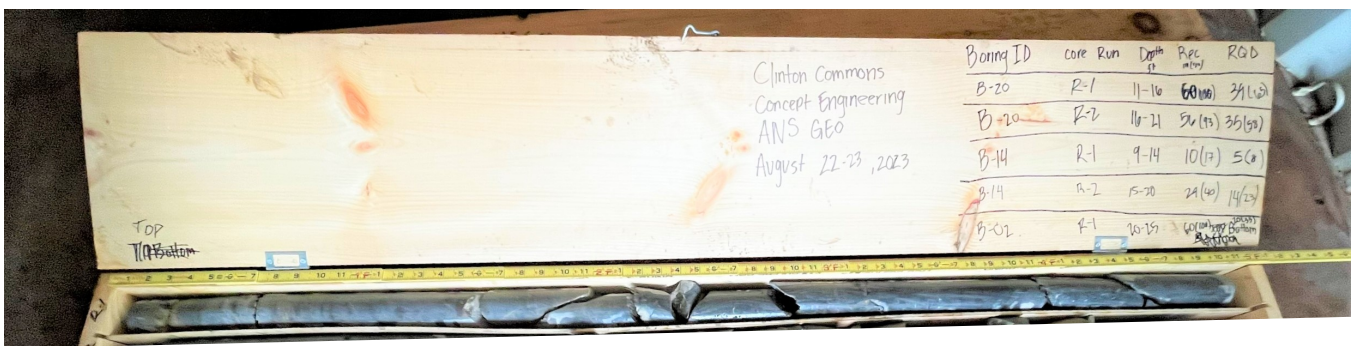
**Rig Model:** CME-55LC      **Casing Type:** Steel      **Core Barrel Type:** NQ      **Core Bit Type:** Diamond  
**Rig Type:** Track      **Casing Length:** 8 feet      **Core Barrel Length:** 5 feet      **Core Bit Length:** 6 inches  
**Drill Method:** Mud Rotary      **Casing I.D.:** 4 inches      **Core Barrel I.D.:** 3 inches      **Core Bit I.D.:** 1.88 inches

Depth (ft)	Avg Core Rate (min/ft)	Run No.	Recovery (in. / %)	RQD (in. / %)	Hardness	Weathering	Graphic Log	Visual Classification	Depth (ft.)	Discontinuities						Drilling & Strata Notes
										Type	Dip Angle	Roughness	Weathering	Aperture	Infilling	
3:56								LIMESTONE, Gray Fine grain, Slightly weathered, Strong,	11.6	J	45	S,Sm	DS	PO	DO	Tan wash.
2:47																
2:28		R-1	60 100%	39 65%	R4	SL		LIMESTONE, Gray Fine grain, Slightly weathered, Strong,	13.5	S	60	S,Sm	DS	PO	DO	Drillers adjusted speed.
2:30									13.75	S	60	S,Sm	DS	T	DO	
2:31									14.25	S	30	S,Sm	DS	VW	DO	
3:25								LIMESTONE, Gray Fine grain, Slightly weathered, Strong	15	S	45	S,Sm	DS	PO	DO	
3:27									15.5	S	0	S,R	DS		DO	
4:11		R-2	56 93%	35 58%				LIMESTONE, Gray Fine grain, Slightly weathered, Strong	16.2	J	20	P,Sm	DS	T	FE	Drillers adjusted speed.
4:54									17	S	30	P,Sm	DS	T	L	Gray wash.
3:35									18	S	30	S,R	DS	T	DO	
									19.2	J	30	S,R	DS	O	DO	
									20	S	30	S,Sm	DS	VW	DO	
								End of boring at 21 feet BGS. Backfilled boring to grade with soil cuttings and bentonite chips.								

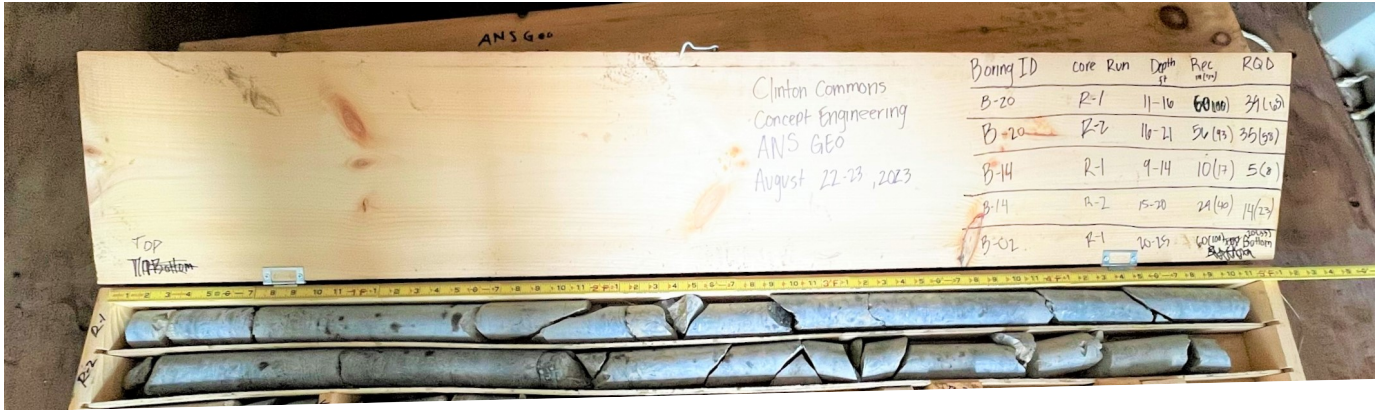
In-Borehole Water Levels				General Notes	
Date / Time	Casing Tip (ft)	Bot. of Hole (ft)	Water Lvl (ft)	▼ = Water Level (if observed)	BGS = Below Ground Surface
				Ground water not observed.	



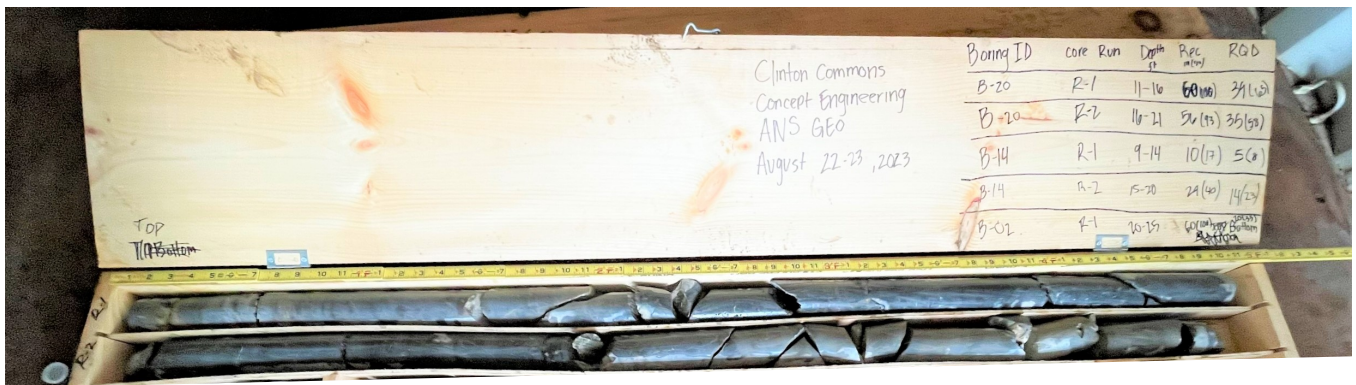
**Figure B-20.1**  
B-20; R-1 (Dry)



**Figure B-20.2**  
B-20; R-1 (Wet)



**Figure B-20.3**  
B-20; R-2 (Dry)



**Figure B-20.4**  
B-20; R-2 (Wet)



## Appendix C

### NRCS Soil Report



United States  
Department of  
Agriculture

**NRCS**

Natural  
Resources  
Conservation  
Service

A product of the National  
Cooperative Soil Survey,  
a joint effort of the United  
States Department of  
Agriculture and other  
Federal agencies, State  
agencies including the  
Agricultural Experiment  
Stations, and local  
participants

# Custom Soil Resource Report for Hunterdon County, New Jersey



# Preface

---

Soil surveys contain information that affects land use planning in survey areas. They highlight soil limitations that affect various land uses and provide information about the properties of the soils in the survey areas. Soil surveys are designed for many different users, including farmers, ranchers, foresters, agronomists, urban planners, community officials, engineers, developers, builders, and home buyers. Also, conservationists, teachers, students, and specialists in recreation, waste disposal, and pollution control can use the surveys to help them understand, protect, or enhance the environment.

Various land use regulations of Federal, State, and local governments may impose special restrictions on land use or land treatment. Soil surveys identify soil properties that are used in making various land use or land treatment decisions. The information is intended to help the land users identify and reduce the effects of soil limitations on various land uses. The landowner or user is responsible for identifying and complying with existing laws and regulations.

Although soil survey information can be used for general farm, local, and wider area planning, onsite investigation is needed to supplement this information in some cases. Examples include soil quality assessments (<http://www.nrcs.usda.gov/wps/portal/nrcs/main/soils/health/>) and certain conservation and engineering applications. For more detailed information, contact your local USDA Service Center (<https://offices.sc.egov.usda.gov/locator/app?agency=nrcs>) or your NRCS State Soil Scientist ([http://www.nrcs.usda.gov/wps/portal/nrcs/detail/soils/contactus/?cid=nrcs142p2\\_053951](http://www.nrcs.usda.gov/wps/portal/nrcs/detail/soils/contactus/?cid=nrcs142p2_053951)).

Great differences in soil properties can occur within short distances. Some soils are seasonally wet or subject to flooding. Some are too unstable to be used as a foundation for buildings or roads. Clayey or wet soils are poorly suited to use as septic tank absorption fields. A high water table makes a soil poorly suited to basements or underground installations.

The National Cooperative Soil Survey is a joint effort of the United States Department of Agriculture and other Federal agencies, State agencies including the Agricultural Experiment Stations, and local agencies. The Natural Resources Conservation Service (NRCS) has leadership for the Federal part of the National Cooperative Soil Survey.

Information about soils is updated periodically. Updated information is available through the NRCS Web Soil Survey, the site for official soil survey information.

The U.S. Department of Agriculture (USDA) prohibits discrimination in all its programs and activities on the basis of race, color, national origin, age, disability, and where applicable, sex, marital status, familial status, parental status, religion, sexual orientation, genetic information, political beliefs, reprisal, or because all or a part of an individual's income is derived from any public assistance program. (Not all prohibited bases apply to all programs.) Persons with disabilities who require

alternative means for communication of program information (Braille, large print, audiotape, etc.) should contact USDA's TARGET Center at (202) 720-2600 (voice and TDD). To file a complaint of discrimination, write to USDA, Director, Office of Civil Rights, 1400 Independence Avenue, S.W., Washington, D.C. 20250-9410 or call (800) 795-3272 (voice) or (202) 720-6382 (TDD). USDA is an equal opportunity provider and employer.



# Contents

---

<b>Preface</b> .....	2
<b>How Soil Surveys Are Made</b> .....	5
<b>Soil Map</b> .....	8
Soil Map.....	9
Legend.....	10
Map Unit Legend.....	11
Map Unit Descriptions.....	11
Hunterdon County, New Jersey.....	13
BhnB—Birdsboro silt loam, 2 to 6 percent slopes.....	13
DufC2—Duffield silt loam, 6 to 12 percent slopes, eroded.....	14
DugDh—Duffield silt loam, 12 to 18 percent slopes, very rocky.....	16
HcuAt—Hatboro-Codorus complex, 0 to 3 percent slopes, frequently flooded.....	17
<b>Soil Information for All Uses</b> .....	20
Suitabilities and Limitations for Use.....	20
Building Site Development.....	20
Corrosion of Concrete.....	20
Corrosion of Steel.....	24
Soil Reports.....	28
Water Features.....	28
Water Features.....	28
<b>References</b> .....	32

# How Soil Surveys Are Made

---

Soil surveys are made to provide information about the soils and miscellaneous areas in a specific area. They include a description of the soils and miscellaneous areas and their location on the landscape and tables that show soil properties and limitations affecting various uses. Soil scientists observed the steepness, length, and shape of the slopes; the general pattern of drainage; the kinds of crops and native plants; and the kinds of bedrock. They observed and described many soil profiles. A soil profile is the sequence of natural layers, or horizons, in a soil. The profile extends from the surface down into the unconsolidated material in which the soil formed or from the surface down to bedrock. The unconsolidated material is devoid of roots and other living organisms and has not been changed by other biological activity.

Currently, soils are mapped according to the boundaries of major land resource areas (MLRAs). MLRAs are geographically associated land resource units that share common characteristics related to physiography, geology, climate, water resources, soils, biological resources, and land uses (USDA, 2006). Soil survey areas typically consist of parts of one or more MLRA.

The soils and miscellaneous areas in a survey area occur in an orderly pattern that is related to the geology, landforms, relief, climate, and natural vegetation of the area. Each kind of soil and miscellaneous area is associated with a particular kind of landform or with a segment of the landform. By observing the soils and miscellaneous areas in the survey area and relating their position to specific segments of the landform, a soil scientist develops a concept, or model, of how they were formed. Thus, during mapping, this model enables the soil scientist to predict with a considerable degree of accuracy the kind of soil or miscellaneous area at a specific location on the landscape.

Commonly, individual soils on the landscape merge into one another as their characteristics gradually change. To construct an accurate soil map, however, soil scientists must determine the boundaries between the soils. They can observe only a limited number of soil profiles. Nevertheless, these observations, supplemented by an understanding of the soil-vegetation-landscape relationship, are sufficient to verify predictions of the kinds of soil in an area and to determine the boundaries.

Soil scientists recorded the characteristics of the soil profiles that they studied. They noted soil color, texture, size and shape of soil aggregates, kind and amount of rock fragments, distribution of plant roots, reaction, and other features that enable them to identify soils. After describing the soils in the survey area and determining their properties, the soil scientists assigned the soils to taxonomic classes (units). Taxonomic classes are concepts. Each taxonomic class has a set of soil characteristics with precisely defined limits. The classes are used as a basis for comparison to classify soils systematically. Soil taxonomy, the system of taxonomic classification used in the United States, is based mainly on the kind and character of soil properties and the arrangement of horizons within the profile. After the soil

## Custom Soil Resource Report

scientists classified and named the soils in the survey area, they compared the individual soils with similar soils in the same taxonomic class in other areas so that they could confirm data and assemble additional data based on experience and research.

The objective of soil mapping is not to delineate pure map unit components; the objective is to separate the landscape into landforms or landform segments that have similar use and management requirements. Each map unit is defined by a unique combination of soil components and/or miscellaneous areas in predictable proportions. Some components may be highly contrasting to the other components of the map unit. The presence of minor components in a map unit in no way diminishes the usefulness or accuracy of the data. The delineation of such landforms and landform segments on the map provides sufficient information for the development of resource plans. If intensive use of small areas is planned, onsite investigation is needed to define and locate the soils and miscellaneous areas.

Soil scientists make many field observations in the process of producing a soil map. The frequency of observation is dependent upon several factors, including scale of mapping, intensity of mapping, design of map units, complexity of the landscape, and experience of the soil scientist. Observations are made to test and refine the soil-landscape model and predictions and to verify the classification of the soils at specific locations. Once the soil-landscape model is refined, a significantly smaller number of measurements of individual soil properties are made and recorded. These measurements may include field measurements, such as those for color, depth to bedrock, and texture, and laboratory measurements, such as those for content of sand, silt, clay, salt, and other components. Properties of each soil typically vary from one point to another across the landscape.

Observations for map unit components are aggregated to develop ranges of characteristics for the components. The aggregated values are presented. Direct measurements do not exist for every property presented for every map unit component. Values for some properties are estimated from combinations of other properties.

While a soil survey is in progress, samples of some of the soils in the area generally are collected for laboratory analyses and for engineering tests. Soil scientists interpret the data from these analyses and tests as well as the field-observed characteristics and the soil properties to determine the expected behavior of the soils under different uses. Interpretations for all of the soils are field tested through observation of the soils in different uses and under different levels of management. Some interpretations are modified to fit local conditions, and some new interpretations are developed to meet local needs. Data are assembled from other sources, such as research information, production records, and field experience of specialists. For example, data on crop yields under defined levels of management are assembled from farm records and from field or plot experiments on the same kinds of soil.

Predictions about soil behavior are based not only on soil properties but also on such variables as climate and biological activity. Soil conditions are predictable over long periods of time, but they are not predictable from year to year. For example, soil scientists can predict with a fairly high degree of accuracy that a given soil will have a high water table within certain depths in most years, but they cannot predict that a high water table will always be at a specific level in the soil on a specific date.

After soil scientists located and identified the significant natural bodies of soil in the survey area, they drew the boundaries of these bodies on aerial photographs and

## Custom Soil Resource Report

identified each as a specific map unit. Aerial photographs show trees, buildings, fields, roads, and rivers, all of which help in locating boundaries accurately.



# Soil Map

---

The soil map section includes the soil map for the defined area of interest, a list of soil map units on the map and extent of each map unit, and cartographic symbols displayed on the map. Also presented are various metadata about data used to produce the map, and a description of each soil map unit.

# Custom Soil Resource Report Soil Map




Map Scale: 1:2,440 if printed on A portrait (8.5" x 11") sheet.



Map projection: Web Mercator Corner coordinates: WGS84 Edge tics: UTM Zone 18N WGS84


### MAP LEGEND

**Area of Interest (AOI)**

 Area of Interest (AOI)




















**Soils**

 Soil Map Unit Polygons

 Soil Map Unit Lines


 Soil Map Unit Points

**Special Point Features**






-  Blowout
-  Borrow Pit
-  Clay Spot
-  Closed Depression
-  Gravel Pit
-  Gravelly Spot
-  Landfill
-  Lava Flow
-  Marsh or swamp
-  Mine or Quarry
-  Miscellaneous Water
-  Perennial Water
-  Rock Outcrop
-  Saline Spot
-  Sandy Spot
-  Severely Eroded Spot
-  Sinkhole
-  Slide or Slip
-  Sodic Spot

-  Spoil Area
-  Stony Spot
-  Very Stony Spot
-  Wet Spot
-  Other
-  Special Line Features

**Water Features**

 Streams and Canals

**Transportation**

-  Rails
-  Interstate Highways
-  US Routes
-  Major Roads
-  Local Roads

**Background**

 Aerial Photography

### MAP INFORMATION

The soil surveys that comprise your AOI were mapped at 1:24,000.

Warning: Soil Map may not be valid at this scale.

Enlargement of maps beyond the scale of mapping can cause misunderstanding of the detail of mapping and accuracy of soil line placement. The maps do not show the small areas of contrasting soils that could have been shown at a more detailed scale.

Please rely on the bar scale on each map sheet for map measurements.

Source of Map: Natural Resources Conservation Service  
 Web Soil Survey URL:  
 Coordinate System: Web Mercator (EPSG:3857)

Maps from the Web Soil Survey are based on the Web Mercator projection, which preserves direction and shape but distorts distance and area. A projection that preserves area, such as the Albers equal-area conic projection, should be used if more accurate calculations of distance or area are required.

This product is generated from the USDA-NRCS certified data as of the version date(s) listed below.

Soil Survey Area: Hunterdon County, New Jersey  
 Survey Area Data: Version 18, Aug 30, 2022

Soil map units are labeled (as space allows) for map scales 1:50,000 or larger.

Date(s) aerial images were photographed: Mar 13, 2021—Sep 14, 2021

The orthophoto or other base map on which the soil lines were compiled and digitized probably differs from the background imagery displayed on these maps. As a result, some minor shifting of map unit boundaries may be evident.

## Map Unit Legend

Map Unit Symbol	Map Unit Name	Acres in AOI	Percent of AOI
BhnB	Birdsboro silt loam, 2 to 6 percent slopes	2.8	13.0%
DufC2	Duffield silt loam, 6 to 12 percent slopes, eroded	14.6	68.2%
DugDh	Duffield silt loam, 12 to 18 percent slopes, very rocky	2.1	9.6%
HcuAt	Hatboro-Codorus complex, 0 to 3 percent slopes, frequently flooded	2.0	9.2%
<b>Totals for Area of Interest</b>		<b>21.5</b>	<b>100.0%</b>

## Map Unit Descriptions

The map units delineated on the detailed soil maps in a soil survey represent the soils or miscellaneous areas in the survey area. The map unit descriptions, along with the maps, can be used to determine the composition and properties of a unit.

A map unit delineation on a soil map represents an area dominated by one or more major kinds of soil or miscellaneous areas. A map unit is identified and named according to the taxonomic classification of the dominant soils. Within a taxonomic class there are precisely defined limits for the properties of the soils. On the landscape, however, the soils are natural phenomena, and they have the characteristic variability of all natural phenomena. Thus, the range of some observed properties may extend beyond the limits defined for a taxonomic class. Areas of soils of a single taxonomic class rarely, if ever, can be mapped without including areas of other taxonomic classes. Consequently, every map unit is made up of the soils or miscellaneous areas for which it is named and some minor components that belong to taxonomic classes other than those of the major soils.

Most minor soils have properties similar to those of the dominant soil or soils in the map unit, and thus they do not affect use and management. These are called noncontrasting, or similar, components. They may or may not be mentioned in a particular map unit description. Other minor components, however, have properties and behavioral characteristics divergent enough to affect use or to require different management. These are called contrasting, or dissimilar, components. They generally are in small areas and could not be mapped separately because of the scale used. Some small areas of strongly contrasting soils or miscellaneous areas are identified by a special symbol on the maps. If included in the database for a given area, the contrasting minor components are identified in the map unit descriptions along with some characteristics of each. A few areas of minor components may not have been observed, and consequently they are not mentioned in the descriptions, especially where the pattern was so complex that it was impractical to make enough observations to identify all the soils and miscellaneous areas on the landscape.



## Custom Soil Resource Report

The presence of minor components in a map unit in no way diminishes the usefulness or accuracy of the data. The objective of mapping is not to delineate pure taxonomic classes but rather to separate the landscape into landforms or landform segments that have similar use and management requirements. The delineation of such segments on the map provides sufficient information for the development of resource plans. If intensive use of small areas is planned, however, onsite investigation is needed to define and locate the soils and miscellaneous areas.

An identifying symbol precedes the map unit name in the map unit descriptions. Each description includes general facts about the unit and gives important soil properties and qualities.

Soils that have profiles that are almost alike make up a *soil series*. Except for differences in texture of the surface layer, all the soils of a series have major horizons that are similar in composition, thickness, and arrangement.

Soils of one series can differ in texture of the surface layer, slope, stoniness, salinity, degree of erosion, and other characteristics that affect their use. On the basis of such differences, a soil series is divided into *soil phases*. Most of the areas shown on the detailed soil maps are phases of soil series. The name of a soil phase commonly indicates a feature that affects use or management. For example, Alpha silt loam, 0 to 2 percent slopes, is a phase of the Alpha series.

Some map units are made up of two or more major soils or miscellaneous areas. These map units are complexes, associations, or undifferentiated groups.

A *complex* consists of two or more soils or miscellaneous areas in such an intricate pattern or in such small areas that they cannot be shown separately on the maps. The pattern and proportion of the soils or miscellaneous areas are somewhat similar in all areas. Alpha-Beta complex, 0 to 6 percent slopes, is an example.

An *association* is made up of two or more geographically associated soils or miscellaneous areas that are shown as one unit on the maps. Because of present or anticipated uses of the map units in the survey area, it was not considered practical or necessary to map the soils or miscellaneous areas separately. The pattern and relative proportion of the soils or miscellaneous areas are somewhat similar. Alpha-Beta association, 0 to 2 percent slopes, is an example.

An *undifferentiated group* is made up of two or more soils or miscellaneous areas that could be mapped individually but are mapped as one unit because similar interpretations can be made for use and management. The pattern and proportion of the soils or miscellaneous areas in a mapped area are not uniform. An area can be made up of only one of the major soils or miscellaneous areas, or it can be made up of all of them. Alpha and Beta soils, 0 to 2 percent slopes, is an example.

Some surveys include *miscellaneous areas*. Such areas have little or no soil material and support little or no vegetation. Rock outcrop is an example.

## Hunterdon County, New Jersey

### BhnB—Birdsboro silt loam, 2 to 6 percent slopes

#### Map Unit Setting

*National map unit symbol:* ldv5  
*Elevation:* 200 to 1,000 feet  
*Mean annual precipitation:* 30 to 64 inches  
*Mean annual air temperature:* 46 to 79 degrees F  
*Frost-free period:* 131 to 178 days  
*Farmland classification:* All areas are prime farmland

#### Map Unit Composition

*Birdsboro and similar soils:* 85 percent  
*Minor components:* 15 percent  
*Estimates are based on observations, descriptions, and transects of the mapunit.*

#### Description of Birdsboro

##### Setting

*Landform:* Stream terraces  
*Landform position (two-dimensional):* Backslope  
*Landform position (three-dimensional):* Tread  
*Down-slope shape:* Linear  
*Across-slope shape:* Linear  
*Parent material:* Old alluvium derived from sandstone and siltstone and/or shale

##### Typical profile

*Ap - 0 to 8 inches:* silt loam  
*BA - 8 to 13 inches:* silt loam  
*Bt - 13 to 29 inches:* silt loam  
*BC - 29 to 40 inches:* silt loam  
*C - 40 to 60 inches:* stratified sand to silty clay loam  
*2C - 60 to 80 inches:* stratified sand to fine sand

##### Properties and qualities

*Slope:* 2 to 6 percent  
*Depth to restrictive feature:* More than 80 inches  
*Drainage class:* Well drained  
*Runoff class:* Low  
*Capacity of the most limiting layer to transmit water (Ksat):* Moderately high to high  
(0.60 to 2.00 in/hr)  
*Depth to water table:* More than 80 inches  
*Frequency of flooding:* None  
*Frequency of ponding:* None  
*Available water supply, 0 to 60 inches:* High (about 10.0 inches)

##### Interpretive groups

*Land capability classification (irrigated):* None specified  
*Land capability classification (nonirrigated):* 2e  
*Hydrologic Soil Group:* B  
*Ecological site:* F148XY025PA - Moist, Triassic, Upland, Mixed Oak - Hardwood -  
Conifer Forest  
*Hydric soil rating:* No

## Minor Components

### Bucks

*Percent of map unit:* 5 percent  
*Landform:* Hills  
*Landform position (two-dimensional):* Backslope  
*Landform position (three-dimensional):* Side slope  
*Down-slope shape:* Linear  
*Across-slope shape:* Convex  
*Hydric soil rating:* No

### Raritan, rarely flooded

*Percent of map unit:* 5 percent  
*Landform:* Stream terraces  
*Landform position (three-dimensional):* Rise  
*Down-slope shape:* Linear  
*Across-slope shape:* Linear  
*Hydric soil rating:* No

### Duffield

*Percent of map unit:* 5 percent  
*Landform:* Hills  
*Landform position (three-dimensional):* Side slope  
*Down-slope shape:* Linear  
*Across-slope shape:* Linear  
*Hydric soil rating:* No

## DufC2—Duffield silt loam, 6 to 12 percent slopes, eroded

### Map Unit Setting

*National map unit symbol:* 1lmfh  
*Elevation:* 300 to 1,000 feet  
*Mean annual precipitation:* 30 to 64 inches  
*Mean annual air temperature:* 46 to 79 degrees F  
*Frost-free period:* 131 to 178 days  
*Farmland classification:* Farmland of statewide importance

### Map Unit Composition

*Duffield, eroded, and similar soils:* 90 percent  
*Minor components:* 10 percent  
*Estimates are based on observations, descriptions, and transects of the mapunit.*

### Description of Duffield, Eroded

#### Setting

*Landform:* Hills  
*Landform position (two-dimensional):* Shoulder  
*Landform position (three-dimensional):* Side slope  
*Down-slope shape:* Linear  
*Across-slope shape:* Linear

## Custom Soil Resource Report

*Parent material:* Fine-loamy residuum weathered from limestone

### Typical profile

*Ap - 0 to 9 inches:* silt loam  
*BA - 9 to 14 inches:* silt loam  
*Bt1 - 14 to 28 inches:* silt loam  
*Bt2 - 28 to 42 inches:* silt loam  
*C - 42 to 56 inches:* loam  
*R - 56 to 80 inches:* unweathered bedrock

### Properties and qualities

*Slope:* 6 to 12 percent  
*Depth to restrictive feature:* 48 to 60 inches to lithic bedrock  
*Drainage class:* Well drained  
*Runoff class:* Medium  
*Capacity of the most limiting layer to transmit water (Ksat):* Moderately high to high  
(0.60 to 2.00 in/hr)  
*Depth to water table:* More than 80 inches  
*Frequency of flooding:* None  
*Frequency of ponding:* None  
*Available water supply, 0 to 60 inches:* High (about 11.1 inches)

### Interpretive groups

*Land capability classification (irrigated):* None specified  
*Land capability classification (nonirrigated):* 3e  
*Hydrologic Soil Group:* B  
*Ecological site:* F148XY026PA - Moist, High Base-Saturation, Upland, Mixed Oak  
- Hickory - Conifer Forest  
*Hydric soil rating:* No

### Minor Components

#### Turbotville

*Percent of map unit:* 5 percent  
*Landform:* Depressions  
*Landform position (two-dimensional):* Toeslope  
*Landform position (three-dimensional):* Base slope  
*Down-slope shape:* Concave  
*Across-slope shape:* Concave  
*Hydric soil rating:* No

#### Washington

*Percent of map unit:* 5 percent  
*Landform:* Hills  
*Landform position (three-dimensional):* Interfluve  
*Down-slope shape:* Linear  
*Across-slope shape:* Linear  
*Hydric soil rating:* No



## DugDh—Duffield silt loam, 12 to 18 percent slopes, very rocky

### Map Unit Setting

*National map unit symbol:* 1lmfk  
*Elevation:* 300 to 1,300 feet  
*Mean annual precipitation:* 30 to 64 inches  
*Mean annual air temperature:* 46 to 79 degrees F  
*Frost-free period:* 131 to 178 days  
*Farmland classification:* Not prime farmland

### Map Unit Composition

*Duffield, eroded, very rocky, and similar soils:* 85 percent  
*Minor components:* 15 percent  
*Estimates are based on observations, descriptions, and transects of the mapunit.*

### Description of Duffield, Eroded, Very Rocky

#### Setting

*Landform:* Hills  
*Landform position (two-dimensional):* Summit  
*Landform position (three-dimensional):* Side slope  
*Down-slope shape:* Linear  
*Across-slope shape:* Linear  
*Parent material:* Fine-loamy residuum weathered from limestone

#### Typical profile

*Ap - 0 to 9 inches:* silt loam  
*BA - 9 to 14 inches:* silt loam  
*Bt1 - 14 to 28 inches:* silt loam  
*Bt2 - 28 to 42 inches:* silt loam  
*C - 42 to 56 inches:* loam  
*R - 56 to 80 inches:* unweathered bedrock

#### Properties and qualities

*Slope:* 12 to 18 percent  
*Depth to restrictive feature:* 48 to 60 inches to lithic bedrock  
*Drainage class:* Well drained  
*Runoff class:* Medium  
*Capacity of the most limiting layer to transmit water (Ksat):* Moderately high to high  
(0.60 to 2.00 in/hr)  
*Depth to water table:* More than 80 inches  
*Frequency of flooding:* None  
*Frequency of ponding:* None  
*Available water supply, 0 to 60 inches:* High (about 11.1 inches)

#### Interpretive groups

*Land capability classification (irrigated):* None specified  
*Land capability classification (nonirrigated):* 4e  
*Hydrologic Soil Group:* B

## Custom Soil Resource Report

*Ecological site:* F148XY026PA - Moist, High Base-Saturation, Upland, Mixed Oak  
- Hickory - Conifer Forest  
*Hydric soil rating:* No

### Minor Components

#### **Turbotville**

*Percent of map unit:* 5 percent  
*Landform:* Depressions  
*Landform position (two-dimensional):* Toeslope  
*Landform position (three-dimensional):* Base slope  
*Down-slope shape:* Concave  
*Across-slope shape:* Concave  
*Hydric soil rating:* No

#### **Washington**

*Percent of map unit:* 5 percent  
*Landform:* Hills  
*Down-slope shape:* Linear  
*Across-slope shape:* Linear  
*Hydric soil rating:* No

#### **Klinesville**

*Percent of map unit:* 5 percent  
*Landform:* Hills  
*Landform position (three-dimensional):* Side slope  
*Down-slope shape:* Linear  
*Across-slope shape:* Linear  
*Hydric soil rating:* No

## **HcuAt—Hatboro-Codorus complex, 0 to 3 percent slopes, frequently flooded**

### **Map Unit Setting**

*National map unit symbol:* 2w06g  
*Elevation:* 90 to 680 feet  
*Mean annual precipitation:* 47 to 51 inches  
*Mean annual air temperature:* 48 to 57 degrees F  
*Frost-free period:* 180 to 210 days  
*Farmland classification:* Not prime farmland

### **Map Unit Composition**

*Hatboro, frequently, and similar soils:* 60 percent  
*Codorus, occasional, and similar soils:* 35 percent  
*Minor components:* 5 percent  
*Estimates are based on observations, descriptions, and transects of the mapunit.*

### **Description of Hatboro, Frequently**

#### **Setting**

*Landform:* Flood plains

## Custom Soil Resource Report

*Landform position (two-dimensional):* Footslope, toeslope

*Landform position (three-dimensional):* Tread

*Down-slope shape:* Linear

*Across-slope shape:* Concave

*Parent material:* Loamy alluvium derived from greenstone and/or phyllite and/or quartzite and/or schist

### Typical profile

*A - 0 to 11 inches:* silt loam

*Bg1 - 11 to 18 inches:* silt loam

*Bg2 - 18 to 29 inches:* silt loam

*BCg - 29 to 44 inches:* silt loam

*Cg1 - 44 to 55 inches:* silty clay loam

*Cg2 - 55 to 80 inches:* sandy loam

### Properties and qualities

*Slope:* 0 to 3 percent

*Depth to restrictive feature:* More than 80 inches

*Drainage class:* Poorly drained

*Runoff class:* Negligible

*Capacity of the most limiting layer to transmit water (Ksat):* Moderately high to high (0.60 to 2.00 in/hr)

*Depth to water table:* About 0 to 6 inches

*Frequency of flooding:* NoneFrequent

*Frequency of ponding:* Frequent

*Available water supply, 0 to 60 inches:* High (about 9.8 inches)

### Interpretive groups

*Land capability classification (irrigated):* None specified

*Land capability classification (nonirrigated):* 5w

*Hydrologic Soil Group:* B/D

*Ecological site:* F148XY030PA - Hydric, Piedmont - felsic, Riparian Zone, Swamp Meadow-Shrub-Forest

*Hydric soil rating:* Yes

## Description of Codorus, Occasional

### Setting

*Landform:* Flood plains

*Landform position (two-dimensional):* Footslope, toeslope

*Landform position (three-dimensional):* Tread

*Down-slope shape:* Linear

*Across-slope shape:* Concave

*Parent material:* Loamy alluvium derived from phyllite and/or mica schist and/or greenstone and/or old loamy alluvium derived from phyllite and/or mica schist and/or greenstone

### Typical profile

*Ap - 0 to 11 inches:* silt loam

*Bw1 - 11 to 18 inches:* silt loam

*Bw2 - 18 to 40 inches:* gravelly silt loam

*2C - 40 to 80 inches:* very gravelly silt loam

### Properties and qualities

*Slope:* 0 to 3 percent

*Depth to restrictive feature:* More than 80 inches

*Drainage class:* Moderately well drained

## Custom Soil Resource Report

*Runoff class:* Low

*Capacity of the most limiting layer to transmit water (Ksat):* Moderately high to high  
(0.57 to 1.98 in/hr)

*Depth to water table:* About 18 to 30 inches

*Frequency of flooding:* OccasionalNone

*Frequency of ponding:* None

*Available water supply, 0 to 60 inches:* Moderate (about 7.9 inches)

### **Interpretive groups**

*Land capability classification (irrigated):* None specified

*Land capability classification (nonirrigated):* 2w

*Hydrologic Soil Group:* C

*Ecological site:* F148XY027PA - Moist, Piedmont - felsic, Riparian Zone, Ecotonal  
Meadow-Shrub-Forest

*Hydric soil rating:* No

### **Minor Components**

#### **Delanco**

*Percent of map unit:* 5 percent

*Landform:* Stream terraces

*Landform position (two-dimensional):* Summit

*Landform position (three-dimensional):* Tread

*Down-slope shape:* Linear

*Across-slope shape:* Convex

*Hydric soil rating:* No



# **Soil Information for All Uses**

---

## **Suitabilities and Limitations for Use**

The Suitabilities and Limitations for Use section includes various soil interpretations displayed as thematic maps with a summary table for the soil map units in the selected area of interest. A single value or rating for each map unit is generated by aggregating the interpretive ratings of individual map unit components. This aggregation process is defined for each interpretation.

## **Building Site Development**

Building site development interpretations are designed to be used as tools for evaluating soil suitability and identifying soil limitations for various construction purposes. As part of the interpretation process, the rating applies to each soil in its described condition and does not consider present land use. Example interpretations can include corrosion of concrete and steel, shallow excavations, dwellings with and without basements, small commercial buildings, local roads and streets, and lawns and landscaping.

## **Corrosion of Concrete**

ENG

Engineering

AGR

Agronomy

"Risk of corrosion" pertains to potential soil-induced electrochemical or chemical action that corrodes or weakens concrete. The rate of corrosion of concrete is based mainly on the sulfate and sodium content, texture, moisture content, and acidity of the soil. Special site examination and design may be needed if the combination of factors results in a severe hazard of corrosion. The concrete in installations that intersect soil boundaries or soil layers is more susceptible to corrosion than the concrete in installations that are entirely within one kind of soil or within one soil layer.

## Custom Soil Resource Report

The risk of corrosion is expressed as "low," "moderate," or "high."

Custom Soil Resource Report  
Map—Corrosion of Concrete























Soil Map may not be valid at this scale.

Map Scale: 1:2,440 if printed on A portrait (8.5" x 11") sheet.



Map projection: Web Mercator Corner coordinates: WGS84 Edge tics: UTM Zone 18N WGS84

### MAP LEGEND

- Area of Interest (AOI)**
  -  Area of Interest (AOI)
- Background**
  -  Aerial Photography
- Soils**
  - Soil Rating Polygons**
    -  High
    -  Moderate
    -  Low
    -  Not rated or not available
  - Soil Rating Lines**
    -  High
    -  Moderate
    -  Low
    -  Not rated or not available
  - Soil Rating Points**
    -  High
    -  Moderate
    -  Low
    -  Not rated or not available
- Water Features**
  -  Streams and Canals
- Transportation**
  -  Rails
  -  Interstate Highways
  -  US Routes
  -  Major Roads
  -  Local Roads

### MAP INFORMATION

The soil surveys that comprise your AOI were mapped at 1:24,000.

Warning: Soil Map may not be valid at this scale.

Enlargement of maps beyond the scale of mapping can cause misunderstanding of the detail of mapping and accuracy of soil line placement. The maps do not show the small areas of contrasting soils that could have been shown at a more detailed scale.

Please rely on the bar scale on each map sheet for map measurements.

Source of Map: Natural Resources Conservation Service  
 Web Soil Survey URL:  
 Coordinate System: Web Mercator (EPSG:3857)

Maps from the Web Soil Survey are based on the Web Mercator projection, which preserves direction and shape but distorts distance and area. A projection that preserves area, such as the Albers equal-area conic projection, should be used if more accurate calculations of distance or area are required.

This product is generated from the USDA-NRCS certified data as of the version date(s) listed below.

Soil Survey Area: Hunterdon County, New Jersey  
 Survey Area Data: Version 18, Aug 30, 2022

Soil map units are labeled (as space allows) for map scales 1:50,000 or larger.

Date(s) aerial images were photographed: Mar 13, 2021—Sep 14, 2021

The orthophoto or other base map on which the soil lines were compiled and digitized probably differs from the background imagery displayed on these maps. As a result, some minor shifting of map unit boundaries may be evident.

**Table—Corrosion of Concrete**

Map unit symbol	Map unit name	Rating	Acres in AOI	Percent of AOI
BhnB	Birdsboro silt loam, 2 to 6 percent slopes	High	2.8	13.0%
DufC2	Duffield silt loam, 6 to 12 percent slopes, eroded	Moderate	14.6	68.2%
DugDh	Duffield silt loam, 12 to 18 percent slopes, very rocky	Moderate	2.1	9.6%
HcuAt	Hatboro-Codorus complex, 0 to 3 percent slopes, frequently flooded	Moderate	2.0	9.2%
<b>Totals for Area of Interest</b>			<b>21.5</b>	<b>100.0%</b>

**Rating Options—Corrosion of Concrete**

*Aggregation Method:* Dominant Condition  
*Component Percent Cutoff:* None Specified  
*Tie-break Rule:* Higher

**Corrosion of Steel**

ENG  
 Engineering  
 AGR  
 Agronomy

"Risk of corrosion" pertains to potential soil-induced electrochemical or chemical action that corrodes or weakens uncoated steel. The rate of corrosion of uncoated steel is related to such factors as soil moisture, particle-size distribution, acidity, and electrical conductivity of the soil. Special site examination and design may be needed if the combination of factors results in a severe hazard of corrosion. The steel in installations that intersect soil boundaries or soil layers is more susceptible to corrosion than the steel in installations that are entirely within one kind of soil or within one soil layer.

The risk of corrosion is expressed as "low," "moderate," or "high."



# Custom Soil Resource Report Map—Corrosion of Steel























Map Scale: 1:2,440 if printed on A portrait (8.5" x 11") sheet.



Map projection: Web Mercator Corner coordinates: WGS84 Edge tics: UTM Zone 18N WGS84

### MAP LEGEND

- Area of Interest (AOI)**
  -  Area of Interest (AOI)
- Background**
  -  Aerial Photography
- Soils**
  - Soil Rating Polygons**
    -  High
    -  Moderate
    -  Low
    -  Not rated or not available
  - Soil Rating Lines**
    -  High
    -  Moderate
    -  Low
    -  Not rated or not available
  - Soil Rating Points**
    -  High
    -  Moderate
    -  Low
    -  Not rated or not available
- Water Features**
  -  Streams and Canals
- Transportation**
  -  Rails
  -  Interstate Highways
  -  US Routes
  -  Major Roads
  -  Local Roads

### MAP INFORMATION

The soil surveys that comprise your AOI were mapped at 1:24,000.

Warning: Soil Map may not be valid at this scale.

Enlargement of maps beyond the scale of mapping can cause misunderstanding of the detail of mapping and accuracy of soil line placement. The maps do not show the small areas of contrasting soils that could have been shown at a more detailed scale.

Please rely on the bar scale on each map sheet for map measurements.

Source of Map: Natural Resources Conservation Service  
 Web Soil Survey URL:  
 Coordinate System: Web Mercator (EPSG:3857)

Maps from the Web Soil Survey are based on the Web Mercator projection, which preserves direction and shape but distorts distance and area. A projection that preserves area, such as the Albers equal-area conic projection, should be used if more accurate calculations of distance or area are required.

This product is generated from the USDA-NRCS certified data as of the version date(s) listed below.

Soil Survey Area: Hunterdon County, New Jersey  
 Survey Area Data: Version 18, Aug 30, 2022

Soil map units are labeled (as space allows) for map scales 1:50,000 or larger.

Date(s) aerial images were photographed: Mar 13, 2021—Sep 14, 2021

The orthophoto or other base map on which the soil lines were compiled and digitized probably differs from the background imagery displayed on these maps. As a result, some minor shifting of map unit boundaries may be evident.

**Table—Corrosion of Steel**

Map unit symbol	Map unit name	Rating	Acres in AOI	Percent of AOI
BhnB	Birdsboro silt loam, 2 to 6 percent slopes	Moderate	2.8	13.0%
DufC2	Duffield silt loam, 6 to 12 percent slopes, eroded	Moderate	14.6	68.2%
DugDh	Duffield silt loam, 12 to 18 percent slopes, very rocky	Moderate	2.1	9.6%
HcuAt	Hatboro-Codorus complex, 0 to 3 percent slopes, frequently flooded	Moderate	2.0	9.2%
<b>Totals for Area of Interest</b>			<b>21.5</b>	<b>100.0%</b>

**Rating Options—Corrosion of Steel**

*Aggregation Method: Dominant Condition*

*Component Percent Cutoff: None Specified*

*Tie-break Rule: Higher*

## Soil Reports

The Soil Reports section includes various formatted tabular and narrative reports (tables) containing data for each selected soil map unit and each component of each unit. No aggregation of data has occurred as is done in reports in the Soil Properties and Qualities and Suitabilities and Limitations sections.

The reports contain soil interpretive information as well as basic soil properties and qualities. A description of each report (table) is included.

## Water Features

This folder contains tabular reports that present soil hydrology information. The reports (tables) include all selected map units and components for each map unit. Water Features include ponding frequency, flooding frequency, and depth to water table.

### Water Features

This table gives estimates of various soil water features. The estimates are used in land use planning that involves engineering considerations.

*Hydrologic soil groups* are based on estimates of runoff potential. Soils are assigned to one of four groups according to the rate of water infiltration when the soils are not protected by vegetation, are thoroughly wet, and receive precipitation from long-duration storms.

The four hydrologic soil groups are:

Group A. Soils having a high infiltration rate (low runoff potential) when thoroughly wet. These consist mainly of deep, well drained to excessively drained sands or gravelly sands. These soils have a high rate of water transmission.

Group B. Soils having a moderate infiltration rate when thoroughly wet. These consist chiefly of moderately deep or deep, moderately well drained or well drained soils that have moderately fine texture to moderately coarse texture. These soils have a moderate rate of water transmission.

Group C. Soils having a slow infiltration rate when thoroughly wet. These consist chiefly of soils having a layer that impedes the downward movement of water or soils of moderately fine texture or fine texture. These soils have a slow rate of water transmission.

Group D. Soils having a very slow infiltration rate (high runoff potential) when thoroughly wet. These consist chiefly of clays that have a high shrink-swell potential, soils that have a high water table, soils that have a claypan or clay layer at or near the surface, and soils that are shallow over nearly impervious material. These soils have a very slow rate of water transmission.

If a soil is assigned to a dual hydrologic group (A/D, B/D, or C/D), the first letter is for drained areas and the second is for undrained areas.



## Custom Soil Resource Report

*Surface runoff* refers to the loss of water from an area by flow over the land surface. Surface runoff classes are based on slope, climate, and vegetative cover. The concept indicates relative runoff for very specific conditions. It is assumed that the surface of the soil is bare and that the retention of surface water resulting from irregularities in the ground surface is minimal. The classes are negligible, very low, low, medium, high, and very high.

The *months* in the table indicate the portion of the year in which a water table, ponding, and/or flooding is most likely to be a concern.

*Water table* refers to a saturated zone in the soil. The water features table indicates, by month, depth to the top ( *upper limit* ) and base ( *lower limit* ) of the saturated zone in most years. Estimates of the upper and lower limits are based mainly on observations of the water table at selected sites and on evidence of a saturated zone, namely grayish colors or mottles (redoximorphic features) in the soil. A saturated zone that lasts for less than a month is not considered a water table. The kind of water table, apparent or perched, is given if a seasonal high water table exists in the soil. A water table is perched if free water is restricted from moving downward in the soil by a restrictive feature, in most cases a hardpan; there is a dry layer of soil underneath a wet layer. A water table is apparent if free water is present in all horizons from its upper boundary to below 2 meters or to the depth of observation. The water table kind listed is for the first major component in the map unit.

*Ponding* is standing water in a closed depression. Unless a drainage system is installed, the water is removed only by percolation, transpiration, or evaporation. The table indicates *surface water depth* and the *duration* and *frequency* of ponding. Duration is expressed as *very brief* if less than 2 days, *brief* if 2 to 7 days, *long* if 7 to 30 days, and *very long* if more than 30 days. Frequency is expressed as none, rare, occasional, and frequent. *None* means that ponding is not probable; *rare* that it is unlikely but possible under unusual weather conditions (the chance of ponding is nearly 0 percent to 5 percent in any year); *occasional* that it occurs, on the average, once or less in 2 years (the chance of ponding is 5 to 50 percent in any year); and *frequent* that it occurs, on the average, more than once in 2 years (the chance of ponding is more than 50 percent in any year).

*Flooding* is the temporary inundation of an area caused by overflowing streams, by runoff from adjacent slopes, or by tides. Water standing for short periods after rainfall or snowmelt is not considered flooding, and water standing in swamps and marshes is considered ponding rather than flooding.

*Duration* and *frequency* are estimated. Duration is expressed as *extremely brief* if 0.1 hour to 4 hours, *very brief* if 4 hours to 2 days, *brief* if 2 to 7 days, *long* if 7 to 30 days, and *very long* if more than 30 days. Frequency is expressed as none, very rare, rare, occasional, frequent, and very frequent. *None* means that flooding is not probable; *very rare* that it is very unlikely but possible under extremely unusual weather conditions (the chance of flooding is less than 1 percent in any year); *rare* that it is unlikely but possible under unusual weather conditions (the chance of flooding is 1 to 5 percent in any year); *occasional* that it occurs infrequently under normal weather conditions (the chance of flooding is 5 to 50 percent in any year); *frequent* that it is likely to occur often under normal weather conditions (the chance of flooding is more than 50 percent in any year but is less than 50 percent in all months in any year); and *very frequent* that it is likely to occur very often under normal weather conditions (the chance of flooding is more than 50 percent in all months of any year).

## Custom Soil Resource Report

The information is based on evidence in the soil profile, namely thin strata of gravel, sand, silt, or clay deposited by floodwater; irregular decrease in organic matter content with increasing depth; and little or no horizon development.

Also considered are local information about the extent and levels of flooding and the relation of each soil on the landscape to historic floods. Information on the extent of flooding based on soil data is less specific than that provided by detailed engineering surveys that delineate flood-prone areas at specific flood frequency levels.

Custom Soil Resource Report

Map unit symbol and soil name	Hydrologic group	Surface runoff	Most likely months	Water table			Ponding			Flooding	
				Upper limit	Lower limit	Kind	Surface depth	Duration	Frequency	Duration	Frequency
				<i>Ft</i>	<i>Ft</i>		<i>Ft</i>				
BhnB—Birdsboro silt loam, 2 to 6 percent slopes											
Birdsboro	B	Low	Jan-Dec	—	—	—	—	—	None	—	None
DufC2—Duffield silt loam, 6 to 12 percent slopes, eroded											
Duffield, eroded	B	Medium	Jan-Dec	—	—	—	—	—	None	—	None
DugDh—Duffield silt loam, 12 to 18 percent slopes, very rocky											
Duffield, eroded, very rocky	B	Medium	Jan-Dec	—	—	—	—	—	None	—	None
HcuAt—Hatboro-Codorus complex, 0 to 3 percent slopes, frequently flooded											
Hatboro, frequently	B/D	Negligible	Jan-May	0.0-0.5	6.0	Apparent	0.0-1.0	Brief (2 to 7 days)	Frequent	Very brief (4 to 48 hours)	Frequent
			Jun-Sep	0.0-0.5	6.0	Apparent	—	—	—	—	—
			Oct	0.0-0.5	6.0	Apparent	0.0-1.0	Brief (2 to 7 days)	Frequent	—	—
			Nov-Dec	0.0-0.5	6.0	Apparent	0.0-1.0	Brief (2 to 7 days)	Frequent	Very brief (4 to 48 hours)	Frequent
Codorus, occasional	C	Low	Jan-Apr	1.5-2.5	6.0	Apparent	—	—	None	Very brief (4 to 48 hours)	Occasional
			May-Oct	1.5-2.5	6.0	Apparent	—	—	None	—	—
			Nov-Dec	1.5-2.5	6.0	Apparent	—	—	None	Very brief (4 to 48 hours)	Occasional



# References

---

- American Association of State Highway and Transportation Officials (AASHTO). 2004. Standard specifications for transportation materials and methods of sampling and testing. 24th edition.
- American Society for Testing and Materials (ASTM). 2005. Standard classification of soils for engineering purposes. ASTM Standard D2487-00.
- Cowardin, L.M., V. Carter, F.C. Golet, and E.T. LaRoe. 1979. Classification of wetlands and deep-water habitats of the United States. U.S. Fish and Wildlife Service FWS/OBS-79/31.
- Federal Register. July 13, 1994. Changes in hydric soils of the United States.
- Federal Register. September 18, 2002. Hydric soils of the United States.
- Hurt, G.W., and L.M. Vasilas, editors. Version 6.0, 2006. Field indicators of hydric soils in the United States.
- National Research Council. 1995. Wetlands: Characteristics and boundaries.
- Soil Survey Division Staff. 1993. Soil survey manual. Soil Conservation Service. U.S. Department of Agriculture Handbook 18. [http://www.nrcs.usda.gov/wps/portal/nrcs/detail/national/soils/?cid=nrcs142p2\\_054262](http://www.nrcs.usda.gov/wps/portal/nrcs/detail/national/soils/?cid=nrcs142p2_054262)
- Soil Survey Staff. 1999. Soil taxonomy: A basic system of soil classification for making and interpreting soil surveys. 2nd edition. Natural Resources Conservation Service, U.S. Department of Agriculture Handbook 436. [http://www.nrcs.usda.gov/wps/portal/nrcs/detail/national/soils/?cid=nrcs142p2\\_053577](http://www.nrcs.usda.gov/wps/portal/nrcs/detail/national/soils/?cid=nrcs142p2_053577)
- Soil Survey Staff. 2010. Keys to soil taxonomy. 11th edition. U.S. Department of Agriculture, Natural Resources Conservation Service. [http://www.nrcs.usda.gov/wps/portal/nrcs/detail/national/soils/?cid=nrcs142p2\\_053580](http://www.nrcs.usda.gov/wps/portal/nrcs/detail/national/soils/?cid=nrcs142p2_053580)
- Tiner, R.W., Jr. 1985. Wetlands of Delaware. U.S. Fish and Wildlife Service and Delaware Department of Natural Resources and Environmental Control, Wetlands Section.
- United States Army Corps of Engineers, Environmental Laboratory. 1987. Corps of Engineers wetlands delineation manual. Waterways Experiment Station Technical Report Y-87-1.
- United States Department of Agriculture, Natural Resources Conservation Service. National forestry manual. [http://www.nrcs.usda.gov/wps/portal/nrcs/detail/soils/home/?cid=nrcs142p2\\_053374](http://www.nrcs.usda.gov/wps/portal/nrcs/detail/soils/home/?cid=nrcs142p2_053374)
- United States Department of Agriculture, Natural Resources Conservation Service. National range and pasture handbook. <http://www.nrcs.usda.gov/wps/portal/nrcs/detail/national/landuse/rangepasture/?cid=stelprdb1043084>

## Custom Soil Resource Report

United States Department of Agriculture, Natural Resources Conservation Service. National soil survey handbook, title 430-VI. [http://www.nrcs.usda.gov/wps/portal/nrcs/detail/soils/scientists/?cid=nrcs142p2\\_054242](http://www.nrcs.usda.gov/wps/portal/nrcs/detail/soils/scientists/?cid=nrcs142p2_054242)

United States Department of Agriculture, Natural Resources Conservation Service. 2006. Land resource regions and major land resource areas of the United States, the Caribbean, and the Pacific Basin. U.S. Department of Agriculture Handbook 296. [http://www.nrcs.usda.gov/wps/portal/nrcs/detail/national/soils/?cid=nrcs142p2\\_053624](http://www.nrcs.usda.gov/wps/portal/nrcs/detail/national/soils/?cid=nrcs142p2_053624)

United States Department of Agriculture, Soil Conservation Service. 1961. Land capability classification. U.S. Department of Agriculture Handbook 210. [http://www.nrcs.usda.gov/Internet/FSE\\_DOCUMENTS/nrcs142p2\\_052290.pdf](http://www.nrcs.usda.gov/Internet/FSE_DOCUMENTS/nrcs142p2_052290.pdf)

## Appendix D

### Laboratory Test Results



**ANS CONSULTANTS, INC.**  
 4405 South Clinton Avenue  
 South Plainfield, NJ 07080

Tel: (800) 585-ATUL  
 (908) 754-8383  
 Fax: (908) 754-8633

NJ EDA Approved Testing Laboratory • MBE/DBE Certified • NJ DEP Certified  
[www.ANSConsultants.net](http://www.ANSConsultants.net)

Soil, Concrete, Masonry, Rebar, Asphalt, Structural Steel, Precast, Piles, Caissons, Fire-Proofing, Roofing, Soil Boring, Concrete/Rock Coring,  
 UST Removal, Environmental Testing & Reports

**Laboratory Determination of Water (Moisture) Content of Soil and Rock (ASTM D2216)**

Client Name: Concept Engineering Consultants

LAB IRN: 23-057

Project Name: Clinton Commons, Clinton, NJ

Date: 8/12/2023

Sample ID	B-06, S-2	B-08, S-2	B-08, S-4	B-10, S-2	B-10, S-3
Depth	2'-4'	2'-4'	6'-8'	2'-4'	4'-6'
Wet soil + Tare (g)	189.2	488.6	556.7	175.2	508.7
Dry soil + Tare (g)	179.7	431.5	525.6	162.7	452.5
Wt. of Tare (g)	121.9	194.7	191.7	115.7	190.4
Moisture Content	<b>16.4%</b>	<b>24.1%</b>	<b>9.3%</b>	<b>26.7%</b>	<b>21.5%</b>

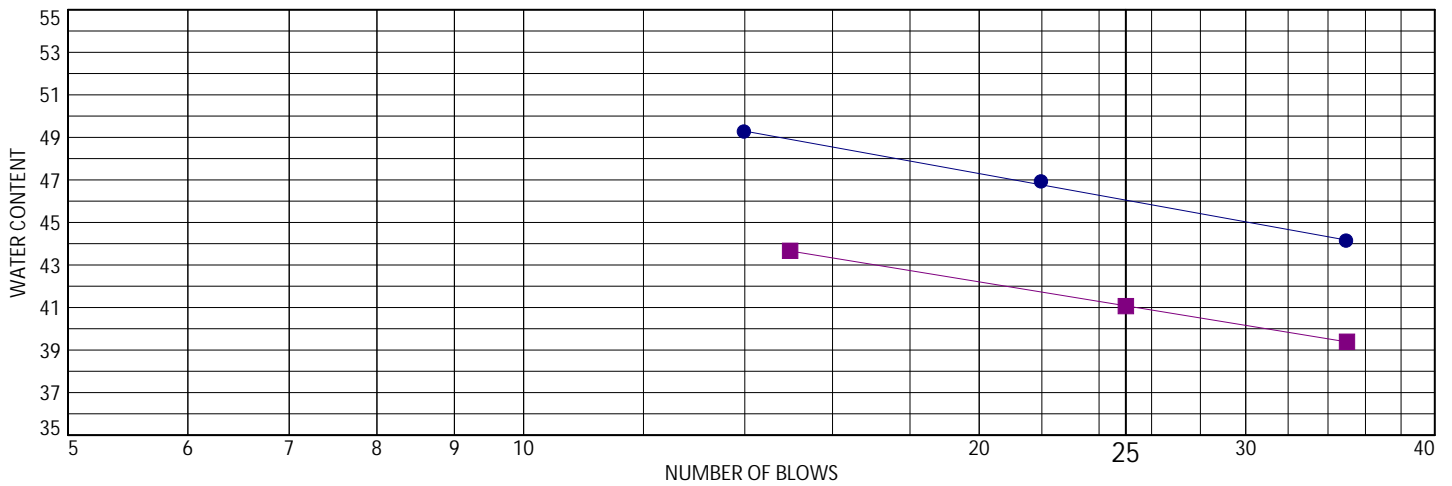
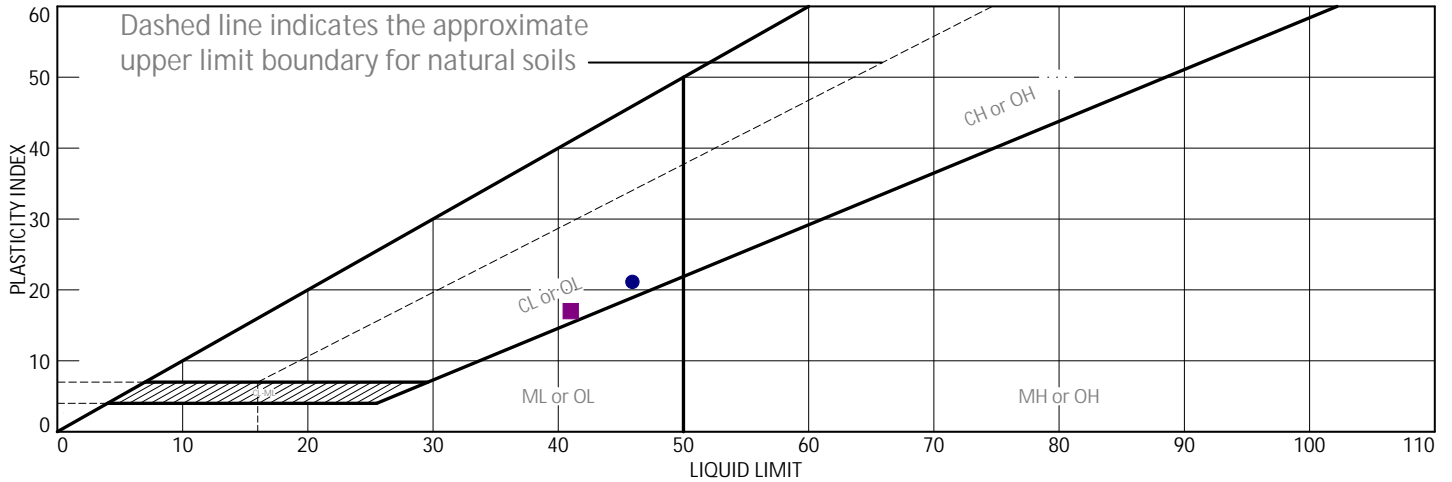
Sample ID	B-12, S-2	B-12, S-3
Depth	2'-4'	4'-6'
Wet soil + Tare (g)	563.9	563.6
Dry soil + Tare (g)	543.3	539.7
Wt. of Tare (g)	194.1	196.2
Moisture Content	<b>5.9%</b>	<b>7.0%</b>

Tested By: AG

Checked By: ANS



# LIQUID AND PLASTIC LIMITS TEST REPORT (ASTM D4318)



	MATERIAL DESCRIPTION	LL	PL	PI	%<#40	%<#200	USCS
●	Light Brown Clay & Silt, trace cmf Sand (Visual)	46	25	21			
■	Brown Clay & Silt, trace cmf Sand (Visual)	41	24	17			

Project No. IRN 23-057 Client: Concept Engineering Consultants  
 Project: Clinton Commons, Clinton, NJ

● Depth: 2'-4' Sample Number: B-06, S-2  
 ■ Depth: 2'-4' Sample Number: B-10, S-2

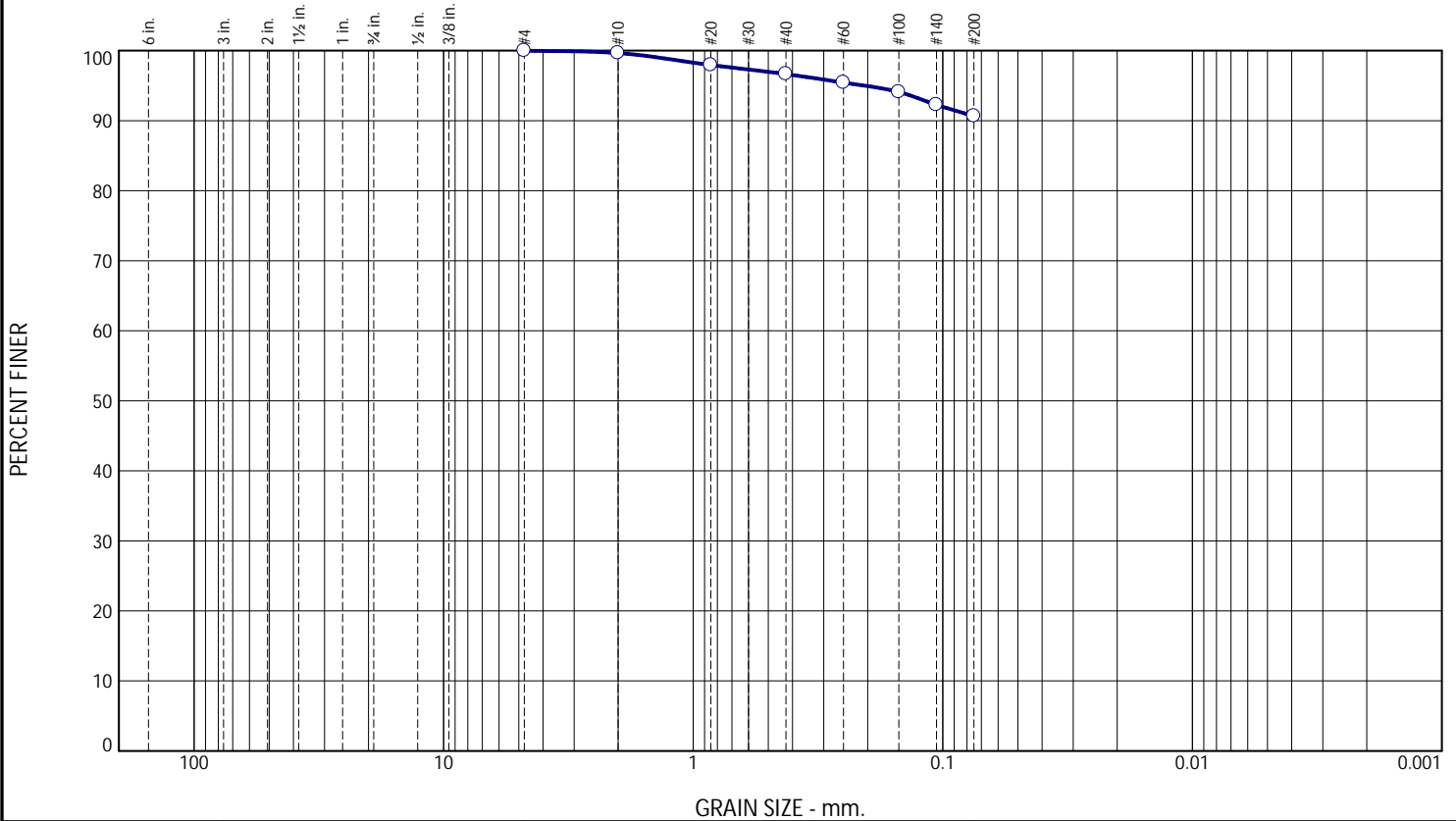
ANS CONSULTANTS, INC.  
 South Plainfield, New Jersey

Remarks:  
 ● ASTM D4318 - Sample Air-Dried,  
 LL Device: Manual, PL Rolling  
 Method: Hand-Rolled, Grooving  
 Tool: Metal  
 8/12/2023

Figure

Tested By: AM Checked By: ANS

# Particle Size Distribution Report (ASTM D6913)



% +3"	% Gravel		% Sand			% Fines	
	Coarse	Fine	Coarse	Medium	Fine	Silt	Clay
0.0	0.0	0.0	0.3	3.0	6.0	90.7	

SIEVE SIZE OR DIAMETER	PERCENT FINER	SPEC. * PERCENT	PASS? (X=NO)
#4	100.0		
#10	99.7		
#20	97.9		
#40	96.7		
#60	95.4		
#100	94.1		
#140	92.3		
#200	90.7		

**Soil Description**  
Dark Brown

**Atterberg Limits**  
 PL=                      LL=                      PI=

**Coefficients**  
 D<sub>90</sub>=                      D<sub>85</sub>=                      D<sub>60</sub>=  
 D<sub>50</sub>=                      D<sub>30</sub>=                      D<sub>15</sub>=  
 D<sub>10</sub>=                      C<sub>u</sub>=                      C<sub>c</sub>=

**Classification**  
 USCS=                      AASHTO=

**Remarks**

\* (no specification provided)

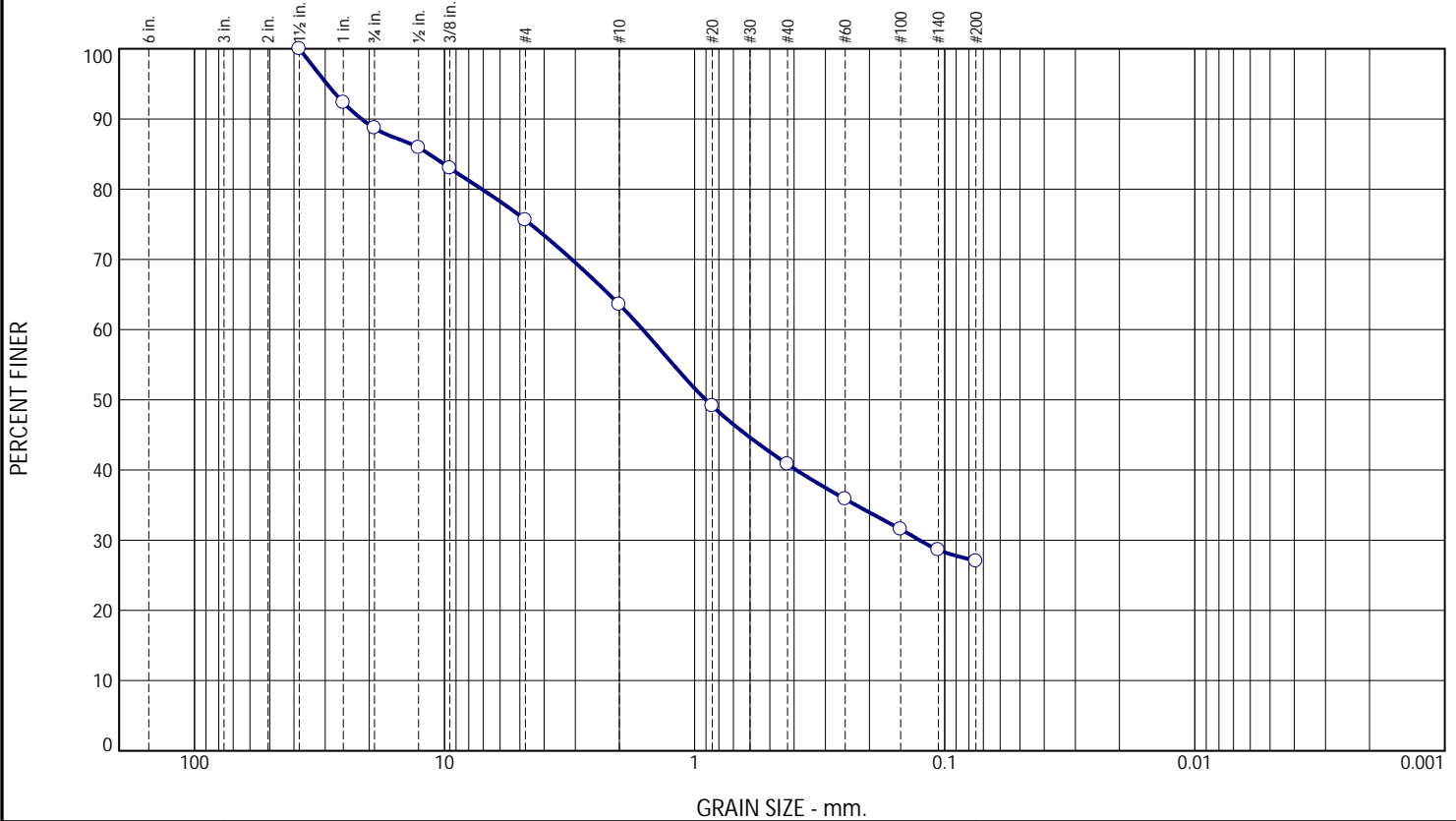
Sample Number: B-08, S-2                      Depth: 2'-4'

Date: 8/12/2023

<b>ANS CONSULTANTS, INC.</b>  South Plainfield, New Jersey	Client:    Concept Engineering Consultants Project:    Clinton Commons, Clinton, NJ  Project No:    IRN 23-057
Figure	

Tested By: MG                      Checked By: ANS

# Particle Size Distribution Report (ASTM D6913)



% +3"	% Gravel		% Sand			% Fines	
	Coarse	Fine	Coarse	Medium	Fine	Silt	Clay
0.0	11.3	13.1	12.0	22.8	13.8	27.0	

SIEVE SIZE OR DIAMETER	PERCENT FINER	SPEC.* PERCENT	PASS? (X=NO)
1.5"	100.0		
1"	92.3		
3/4"	88.7		
1/2"	85.9		
3/8"	83.0		
#4	75.6		
#10	63.6		
#20	49.1		
#40	40.8		
#60	35.9		
#100	31.6		
#140	28.6		
#200	27.0		

Soil Description

Grayish Brown

PL=                      Atterberg Limits                      PI=

LL=                      LL=                      PI=

Coefficients

D<sub>90</sub>= 21.4740      D<sub>85</sub>= 11.5115      D<sub>60</sub>= 1.6112

D<sub>50</sub>= 0.9021      D<sub>30</sub>= 0.1260      D<sub>15</sub>=

D<sub>10</sub>=                      C<sub>u</sub>=                      C<sub>c</sub>=

USCS=                      Classification                      AASHTO=

Remarks

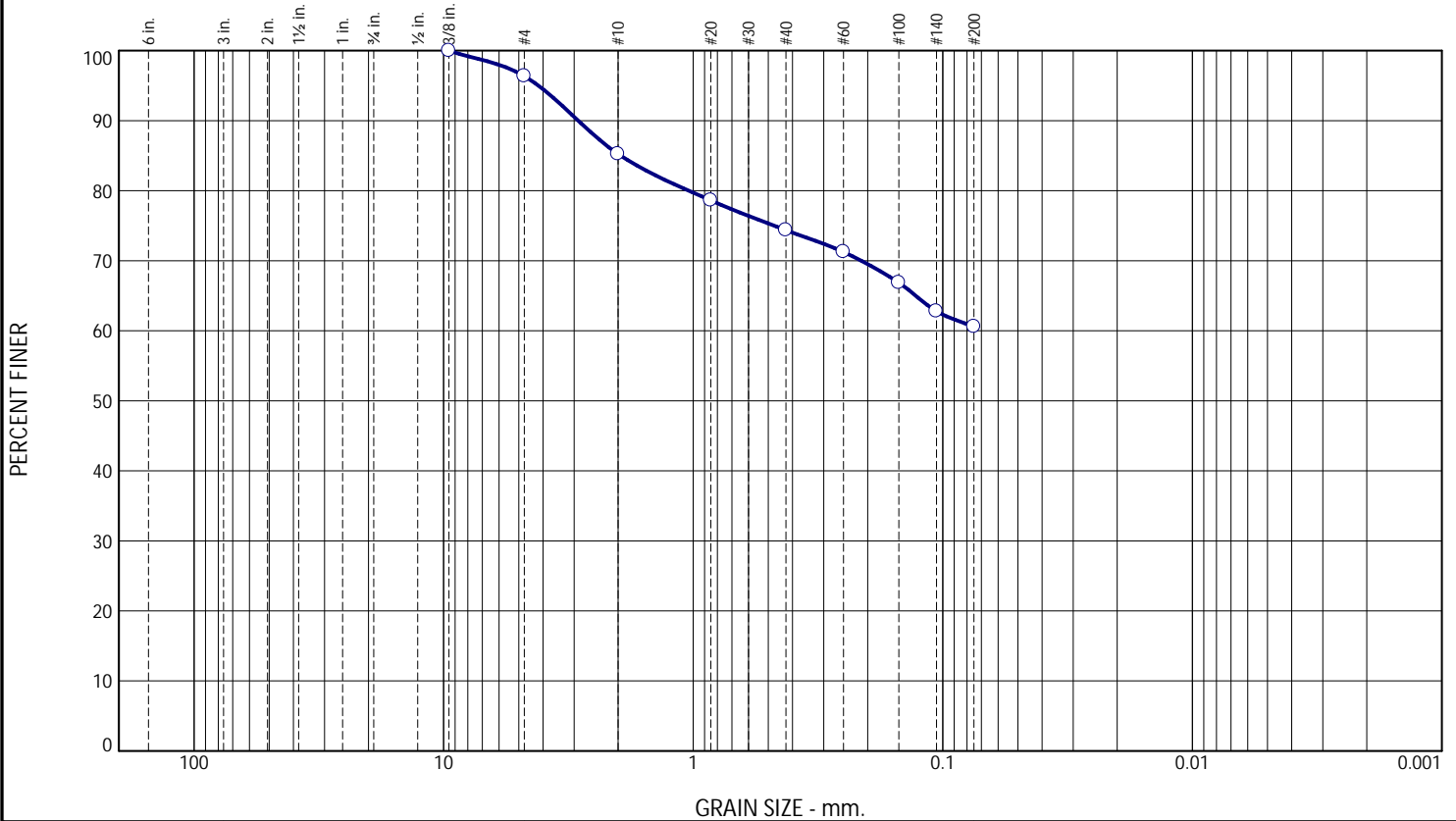
\* (no specification provided)

Sample Number: B-08, S-4      Depth: 6'-8'      Date: 8/12/2023

<p><b>ANS CONSULTANTS, INC.</b></p> <p>South Plainfield, New Jersey</p>	<p>Client: Concept Engineering Consultants</p> <p>Project: Clinton Commons, Clinton, NJ</p> <p>Project No: IRN 23-057</p> <p style="text-align: right;">Figure</p>
-------------------------------------------------------------------------	--------------------------------------------------------------------------------------------------------------------------------------------------------------------

Tested By: MG      Checked By: ANS

# Particle Size Distribution Report (ASTM D6913)



% +3"	% Gravel		% Sand			% Fines	
	Coarse	Fine	Coarse	Medium	Fine	Silt	Clay
0.0	0.0	3.6	11.2	10.8	13.8	60.6	

SIEVE SIZE OR DIAMETER	PERCENT FINER	SPEC.* PERCENT	PASS? (X=NO)
3/8"	100.0		
#4	96.4		
#10	85.2		
#20	78.6		
#40	74.4		
#60	71.3		
#100	66.9		
#140	62.8		
#200	60.6		

Soil Description

Dark Brown

PL=                      Atterberg Limits                      PI=

LL=

Coefficients

D<sub>90</sub>= 2.8873                      D<sub>85</sub>= 1.9518                      D<sub>60</sub>=

D<sub>50</sub>=                                      D<sub>30</sub>=                                      D<sub>15</sub>=

D<sub>10</sub>=                                      C<sub>u</sub>=                                      C<sub>c</sub>=

USCS=                      Classification                      AASHTO=

Remarks

\* (no specification provided)

Sample Number: B-10, S-3                      Depth: 4'-6'

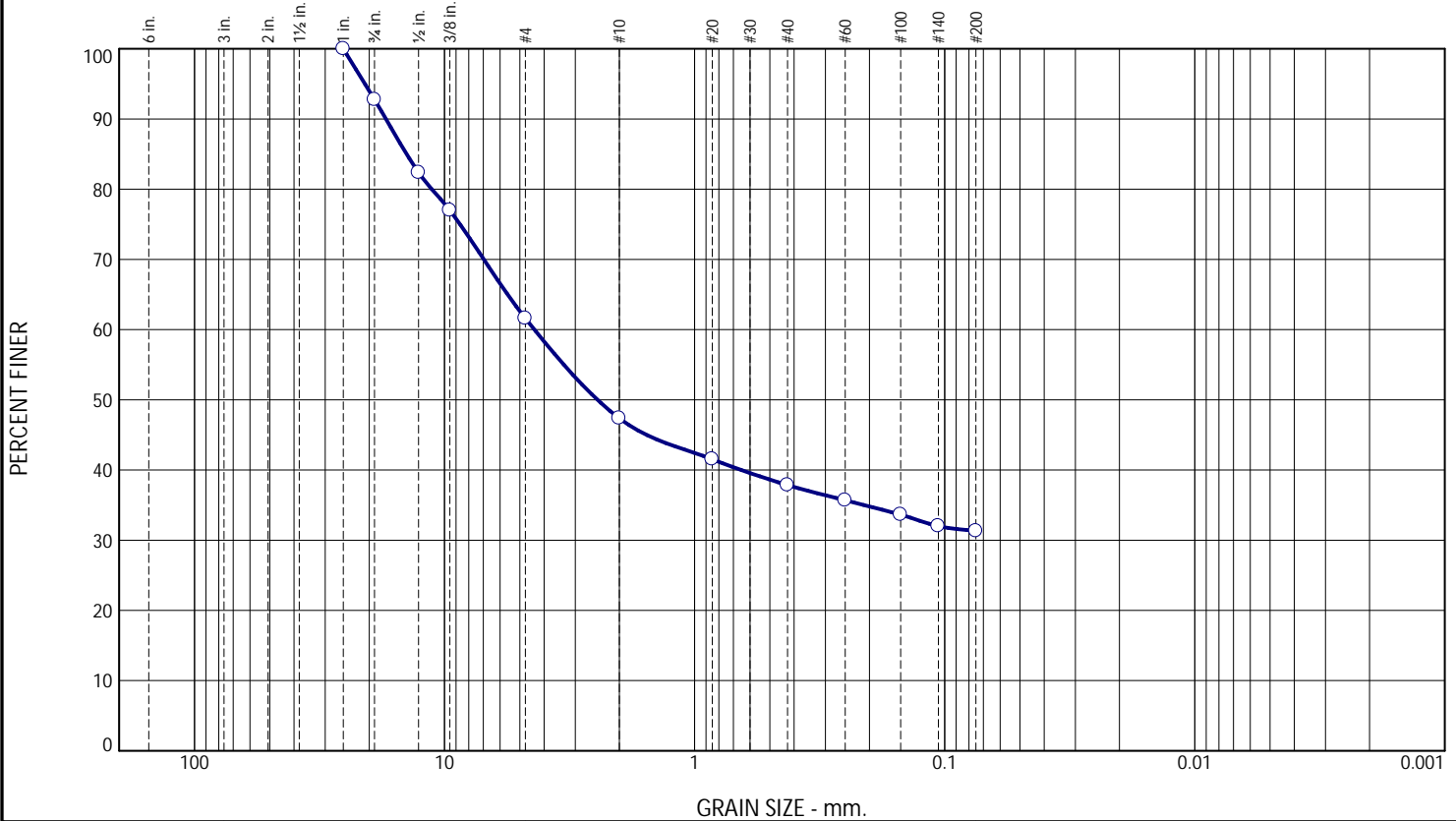
Date: 8/12/2023

<p style="text-align: center; font-weight: bold; font-size: 1.2em;">ANS CONSULTANTS, INC.</p> <p style="text-align: center; font-weight: bold;">South Plainfield, New Jersey</p>	<p>Client:    Concept Engineering Consultants</p> <p>Project:    Clinton Commons, Clinton, NJ</p> <p>Project No:    IRN 23-057</p>
<p>Figure</p>	

Tested By: MG                      Checked By: ANS



# Particle Size Distribution Report (ASTM D6913)



% +3"	% Gravel		% Sand			% Fines	
	Coarse	Fine	Coarse	Medium	Fine	Silt	Clay
0.0	7.2	31.2	14.2	9.6	6.5	31.3	

SIEVE SIZE OR DIAMETER	PERCENT FINER	SPEC.* PERCENT	PASS? (X=NO)
1"	100.0		
3/4"	92.8		
1/2"	82.4		
3/8"	77.0		
#4	61.6		
#10	47.4		
#20	41.5		
#40	37.8		
#60	35.7		
#100	33.6		
#140	32.0		
#200	31.3		

Soil Description

Dark Gray silty gravel with sand

PL= NP	<u>Atterberg Limits</u>	PI= NP
	LL= NV	

	<u>Coefficients</u>	
D <sub>90</sub> = 17.1466	D <sub>85</sub> = 14.1838	D <sub>60</sub> = 4.3710
D <sub>50</sub> = 2.4461	D <sub>30</sub> =	D <sub>15</sub> =
D <sub>10</sub> =	C <sub>u</sub> =	C <sub>c</sub> =

USCS= GM	<u>Classification</u>	AASHTO= A-2-4(0)
----------	-----------------------	------------------

Remarks

\* (no specification provided)

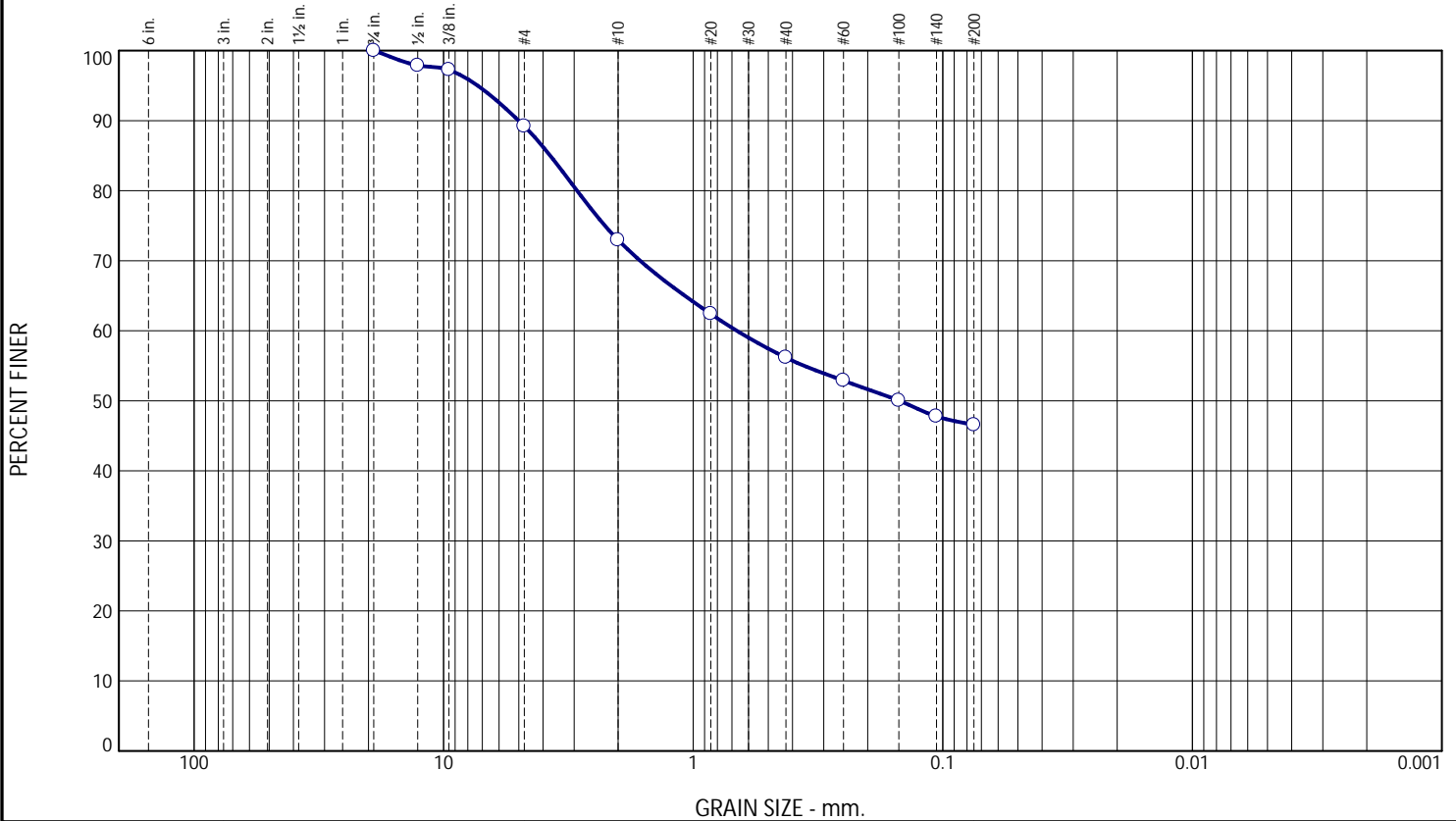
Sample Number: B-12, S-2      Depth: 2'-4'

Date: 8/12/2023

<p><b>ANS CONSULTANTS, INC.</b></p> <p>South Plainfield, New Jersey</p>	<p>Client: Concept Engineering Consultants</p> <p>Project: Clinton Commons, Clinton, NJ</p> <p>Project No: IRN 23-057</p>
<p>Figure</p>	

Tested By: MG      Checked By: ANS

# Particle Size Distribution Report (ASTM D6913)



% +3"	% Gravel		% Sand			% Fines	
	Coarse	Fine	Coarse	Medium	Fine	Silt	Clay
0.0	0.0	10.8	16.2	16.8	9.7	46.5	

SIEVE SIZE OR DIAMETER	PERCENT FINER	SPEC.* PERCENT	PASS? (X=NO)
3/4"	100.0		
1/2"	97.9		
3/8"	97.3		
#4	89.2		
#10	73.0		
#20	62.4		
#40	56.2		
#60	52.9		
#100	50.0		
#140	47.8		
#200	46.5		

Soil Description

Gray silty sand

PL= NP      Atterberg Limits      LL= NV      PI= NP

Coefficients

D<sub>90</sub>= 5.0086      D<sub>85</sub>= 3.7386      D<sub>60</sub>= 0.6689  
D<sub>50</sub>= 0.1492      D<sub>30</sub>=      D<sub>15</sub>=  
D<sub>10</sub>=      C<sub>u</sub>=      C<sub>c</sub>=

Classification

USCS= SM      AASHTO= A-4(0)

Remarks

\* (no specification provided)

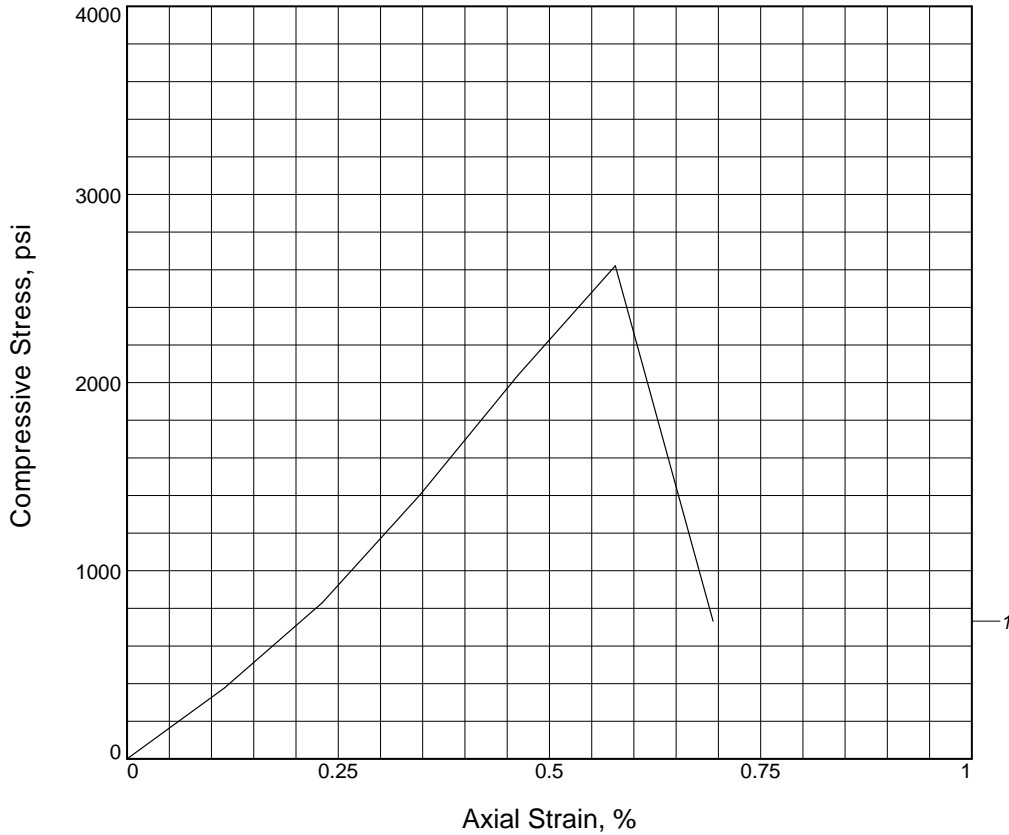
Sample Number: B-12, S-3      Depth: 4'-6'

Date: 8/12/2023

<p style="text-align: center; font-weight: bold; font-size: 1.2em;">ANS CONSULTANTS, INC.</p> <p style="text-align: center;">South Plainfield, New Jersey</p>	<p>Client: Concept Engineering Consultants  Project: Clinton Commons, Clinton, NJ</p> <p>Project No: IRN 23-057</p>
---------------------------------------------------------------------------------------------------------------------------------------------------------------	-------------------------------------------------------------------------------------------------------------------------

Tested By: MG      Checked By: ANS

# UNCONFINED COMPRESSION TEST



Sample No.	1			
Unconfined strength, psi	2620.69			
Undrained shear strength, psi	1310.35			
Failure strain, %	0.6			
Strain rate, in./min.	N/A			
Water content, %	0.0			
Wet density, pcf	174.7			
Dry density, pcf	174.7			
Saturation, %	0.0			
Void ratio	0.0721			
Specimen diameter, in.	1.97			
Specimen height, in.	4.33			
Height/diameter ratio	2.20			

**Description:** Gray Rock Core

**LL =**      **PL =**      **PI =**      **Assumed GS= 3**      **Type:**

**Project No.:** IRN 23-057  
**Date Sampled:** 8/12/2023  
**Remarks:**  
 ASTM D7012 - Method C  
 Loading Manner: Constant Stress Rate (0.5 MPa/sec)

**Client:** Concept Engineering Consultants  
**Project:** Clinton Commons, Clinton, NJ  
**Sample Number:** B-05, R-1      **Depth:** 7'7"-8'3"

UNCONFINED COMPRESSION TEST  
 ANS CONSULTANTS, INC.  
 South Plainfield, New Jersey

**Figure** \_\_\_\_\_

**Tested By:** MM \_\_\_\_\_ **Checked By:** ANS \_\_\_\_\_

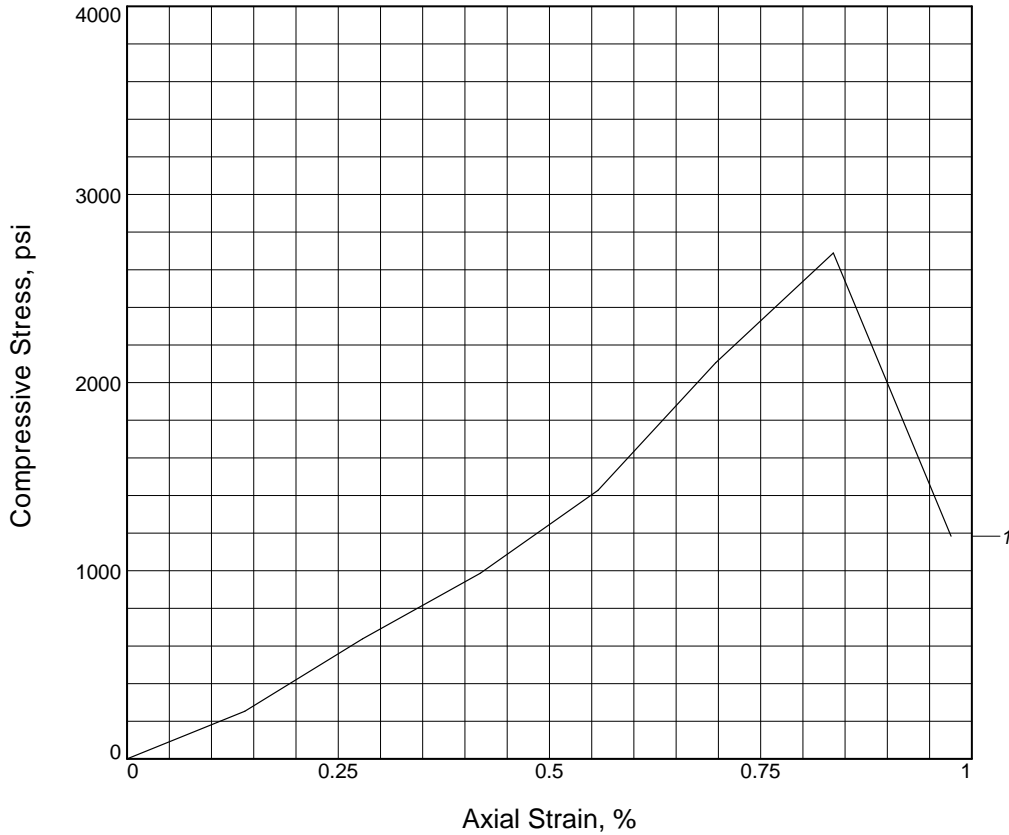


23057  
B-05, R-1





# UNCONFINED COMPRESSION TEST



Sample No.	1			
Unconfined strength, psi	2689.18			
Undrained shear strength, psi	1344.59			
Failure strain, %	0.8			
Strain rate, in./min.	N/A			
Water content, %	0.0			
Wet density, pcf	170.7			
Dry density, pcf	170.7			
Saturation, %	0.0			
Void ratio	0.0974			
Specimen diameter, in.	1.98			
Specimen height, in.	3.59			
Height/diameter ratio	1.81			

**Description:** Gray Rock Core

<b>LL =</b>	<b>PL =</b>	<b>PI =</b>	<b>Assumed GS= 3</b>	<b>Type:</b>
-------------	-------------	-------------	----------------------	--------------

**Project No.:** IRN 23-057  
**Date Sampled:** 8/12/2023  
**Remarks:**  
 ASTM D7012 - Method C  
 Loading Manner: Constant Stress Rate (0.5 MPa/sec)  
 H/D Ratio < 2.0

**Client:** Concept Engineering Consultants  
**Project:** Clinton Commons, Clinton, NJ  
**Sample Number:** B-12, R-1      **Depth:** 12'2"-12'7"

UNCONFINED COMPRESSION TEST  
 ANS CONSULTANTS, INC.  
 South Plainfield, New Jersey

**Figure** \_\_\_\_\_

**Tested By:** MM \_\_\_\_\_ **Checked By:** ANS \_\_\_\_\_

23-057

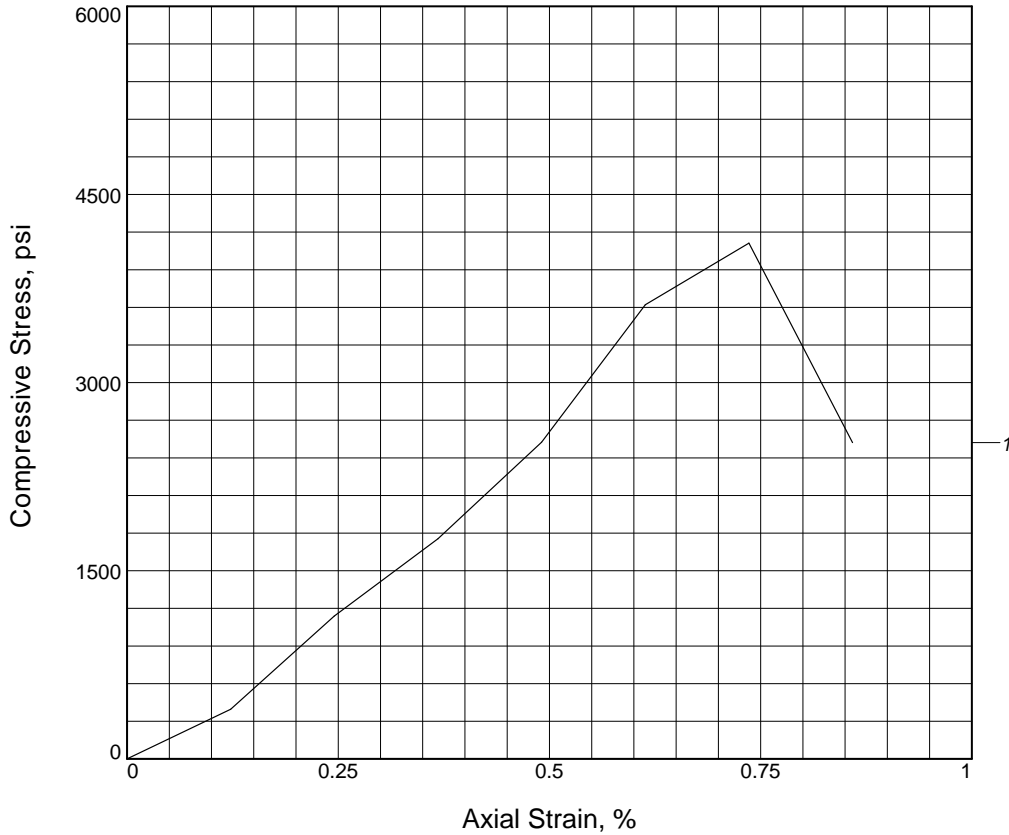
B-12, R-1

B-12, R-1





# UNCONFINED COMPRESSION TEST



Sample No.	1		
Unconfined strength, psi	4112.66		
Undrained shear strength, psi	2056.33		
Failure strain, %	0.7		
Strain rate, in./min.	N/A		
Water content, %	0.0		
Wet density, pcf	170.1		
Dry density, pcf	170.1		
Saturation, %	0.0		
Void ratio	0.1009		
Specimen diameter, in.	1.98		
Specimen height, in.	4.08		
Height/diameter ratio	2.06		

**Description:** Gray Rock Core

<b>LL =</b>	<b>PL =</b>	<b>PI =</b>	<b>Assumed GS= 3</b>	<b>Type:</b>
-------------	-------------	-------------	----------------------	--------------

**Project No.:** IRN 23-057  
**Date Sampled:** 8/12/2023  
**Remarks:**  
 ASTM D7012 - Method C  
 Loading Manner: Constant Stress Rate (0.5 MPa/sec)

**Client:** Concept Engineering Consultants  
**Project:** Clinton Commons, Clinton, NJ  
**Sample Number:** B-15, R-1      **Depth:** 6'5"-7'1"

UNCONFINED COMPRESSION TEST  
 ANS CONSULTANTS, INC.  
 South Plainfield, New Jersey

**Figure** \_\_\_\_\_

**Tested By:** MM \_\_\_\_\_ **Checked By:** ANS \_\_\_\_\_

Johnson  
A Family Company

Ziploc®

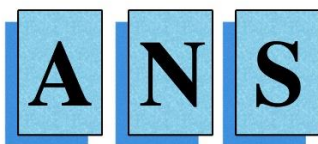
23-057

B-15, R-1

POWER SHIELD  
Technology







**ANS CONSULTANTS, INC.**

4405 South Clinton Avenue  
South Plainfield, NJ 07080

**NJ EDA Approved Testing Laboratory • MBE/DBE Certified • NJ DEP Certified**

[www.ANSConsultants.net](http://www.ANSConsultants.net)

**Tel: (800) 585-ATUL**

**(908) 754-8383**

**Fax: (908) 754-8633**

---

Soil, Concrete, Masonry, Rebar, Asphalt, Structural Steel, Precast, Piles, Caissons, Fire-Proofing, Roofing, Soil Boring, Concrete/Rock Coring,  
UST Removal, Environmental Testing & Reports

---

August 26, 2023

ANS Geo, Inc  
4405 South Clinton Ave, Suite A  
South Plainfield, NJ 07080

Attn: Dr. Vatsal A. Shah, Ph.D, P.E, D.GE

CC: Thileepan Rajah, PE  
Janivel Leo  
Anton Luz

Re: Laboratory Test Results  
Concept Engineering Consultants – Clinton Commons  
Clinton, NJ  
Lab IRN: 23-082

Dear Dr. Shah,

Please find attached the laboratory test results. The following testing was conducted on the samples:

1. ASTM D2216 Water (Moisture) Content (x8 Tests)
2. ASTM D4318 Liquid Limit, Plastic Limit, and Plasticity Index of Soils (x3 Tests)
3. ASTM D6913 Particle-Size Distribution (Gradation) of Soils Using Sieve Analysis (x4 Tests)
4. ASTM D1557 Compaction Characteristics of Soil Using Modified Effort (x1 Test)
5. ASTM D7012 Compressive Strength of Intact Rock Core Specimens (x2 Tests)

Should you have any questions, please do not hesitate to contact the undersigned at 908-754-8383.

Sincerely,  
ANS Consultants, Inc.

Atulkumar N. Shah, PE, PP, F.ASCE  
President

---

*The laboratory testing conducted by ANS Consultants, Inc. adheres to the applicable ASTM standards and widely accepted industry practices. It is important to note that no other representations or warranties, whether expressed or implied, are provided. ANS Consultants, Inc. assumes no responsibility for the ultimate use and purpose of the tested material. This report is intended solely for the client's use and must not be utilized or relied upon by others. The contents of these documents are considered proprietary information and should not be reproduced without the written consent of ANS Consultants, Inc.*



**ANS CONSULTANTS, INC.**4405 South Clinton Avenue  
South Plainfield, NJ 07080

NJ EDA Approved Testing Laboratory • MBE/DBE Certified • NJ DEP Certified

[www.ANSConsultants.net](http://www.ANSConsultants.net)

Tel: (800) 585-ATUL

(908) 754-8383

Fax: (908) 754-8633

Soil, Concrete, Masonry, Rebar, Asphalt, Structural Steel, Precast, Piles, Caissons, Fire-Proofing, Roofing, Soil Boring, Concrete/Rock Coring,  
UST Removal, Environmental Testing & Reports**Laboratory Determination of Water (Moisture) Content of Soil and Rock (ASTM D2216)**

Client Name: Concept Engineering Consultants

LAB IRN: 23-082

Project Name: Clinton Commons, Clinton, NJ

Date: 8/26/2023

Sample ID	B-02, S-7	B-14, S-4	B-16, S-3	B-16, S-8	B-17, S-2
Depth	15'-17'	7'-9'	4'-6'	20'-22'	2'-4'
Wet soil + Tare (g)	190.5	365.0	666.0	476.0	1177.0
Dry soil + Tare (g)	160.3	295.0	625.3	399.6	1107.2
Wt. of Tare (g)	13.8	13.8	190.0	13.8	195.5
Moisture Content	<b>20.6%</b>	<b>24.9%</b>	<b>9.3%</b>	<b>19.8%</b>	<b>7.7%</b>

Sample ID	B-18, S-3	B-19, S-2	Bulk, S-1
Depth	4'-6'	2'-4'	0'-2'
Wet soil + Tare (g)	1058.0	1033.5	273.8
Dry soil + Tare (g)	964.2	963.1	230.8
Wt. of Tare (g)	198.2	191.4	13.7
Moisture Content	<b>12.2%</b>	<b>9.1%</b>	<b>19.8%</b>

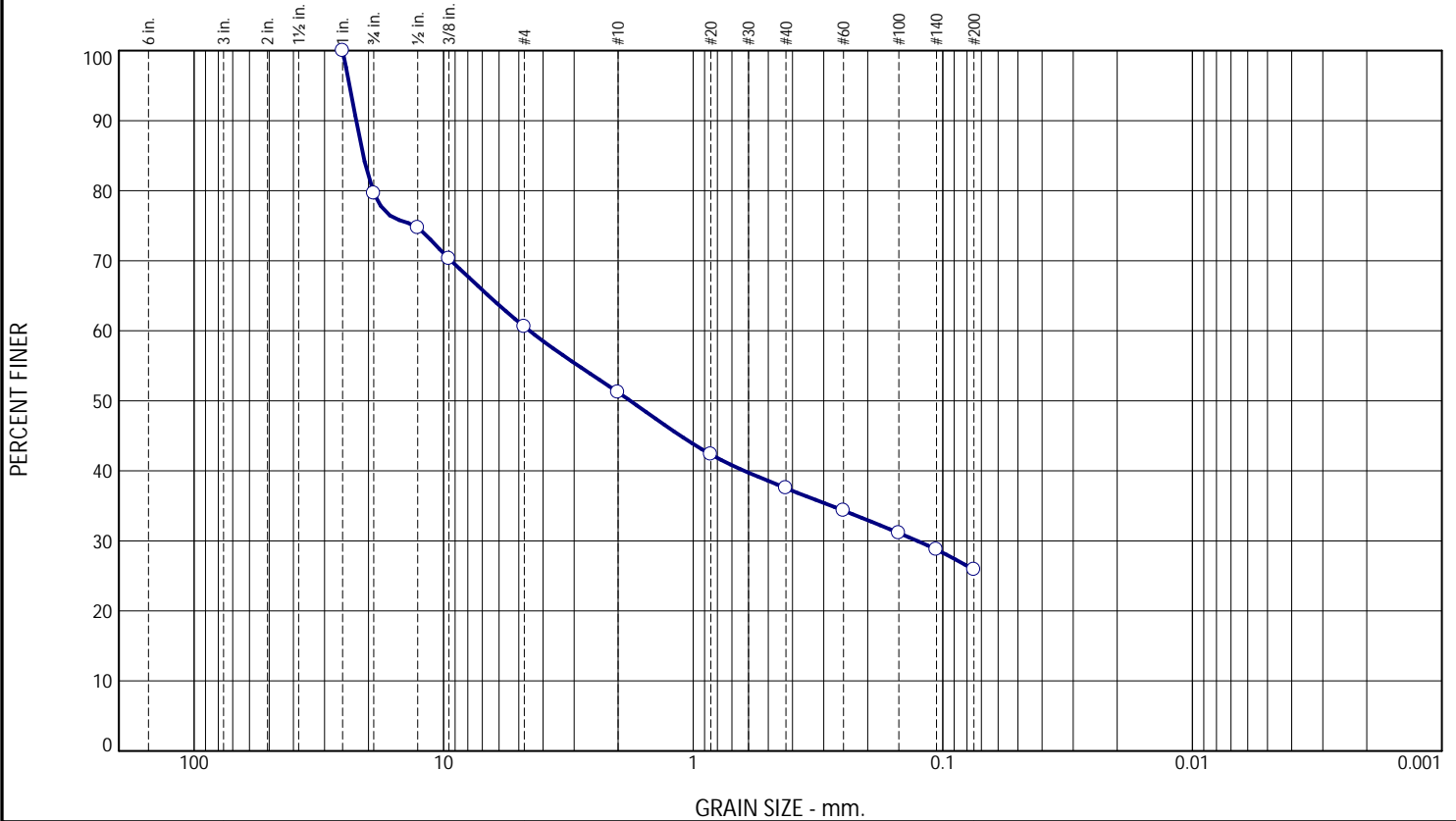
Tested By: AA/CK

Checked By: ANS





# Particle Size Distribution Report (ASTM D6913)



% +3"	% Gravel		% Sand			% Fines	
	Coarse	Fine	Coarse	Medium	Fine	Silt	Clay
0.0	20.4	19.0	9.4	13.7	11.6	25.9	

SIEVE SIZE OR DIAMETER	PERCENT FINER	SPEC.* PERCENT	PASS? (X=NO)
1"	100.0		
3/4"	79.6		
1/2"	74.7		
3/8"	70.3		
#4	60.6		
#10	51.2		
#20	42.3		
#40	37.5		
#60	34.3		
#100	31.1		
#140	28.7		
#200	25.9		

Soil Description

Dark Brown silty gravel with sand

PL= NP	<u>Atterberg Limits</u>	PI= NP
	LL= NV	

	<u>Coefficients</u>	
D <sub>90</sub> = 22.4014	D <sub>85</sub> = 20.9977	D <sub>60</sub> = 4.5269
D <sub>50</sub> = 1.7876	D <sub>30</sub> = 0.1266	D <sub>15</sub> =
D <sub>10</sub> =	C <sub>u</sub> =	C <sub>c</sub> =

USCS= GM	<u>Classification</u>	AASHTO= A-2-4(0)
----------	-----------------------	------------------

Remarks

Undersized specimen

\* (no specification provided)

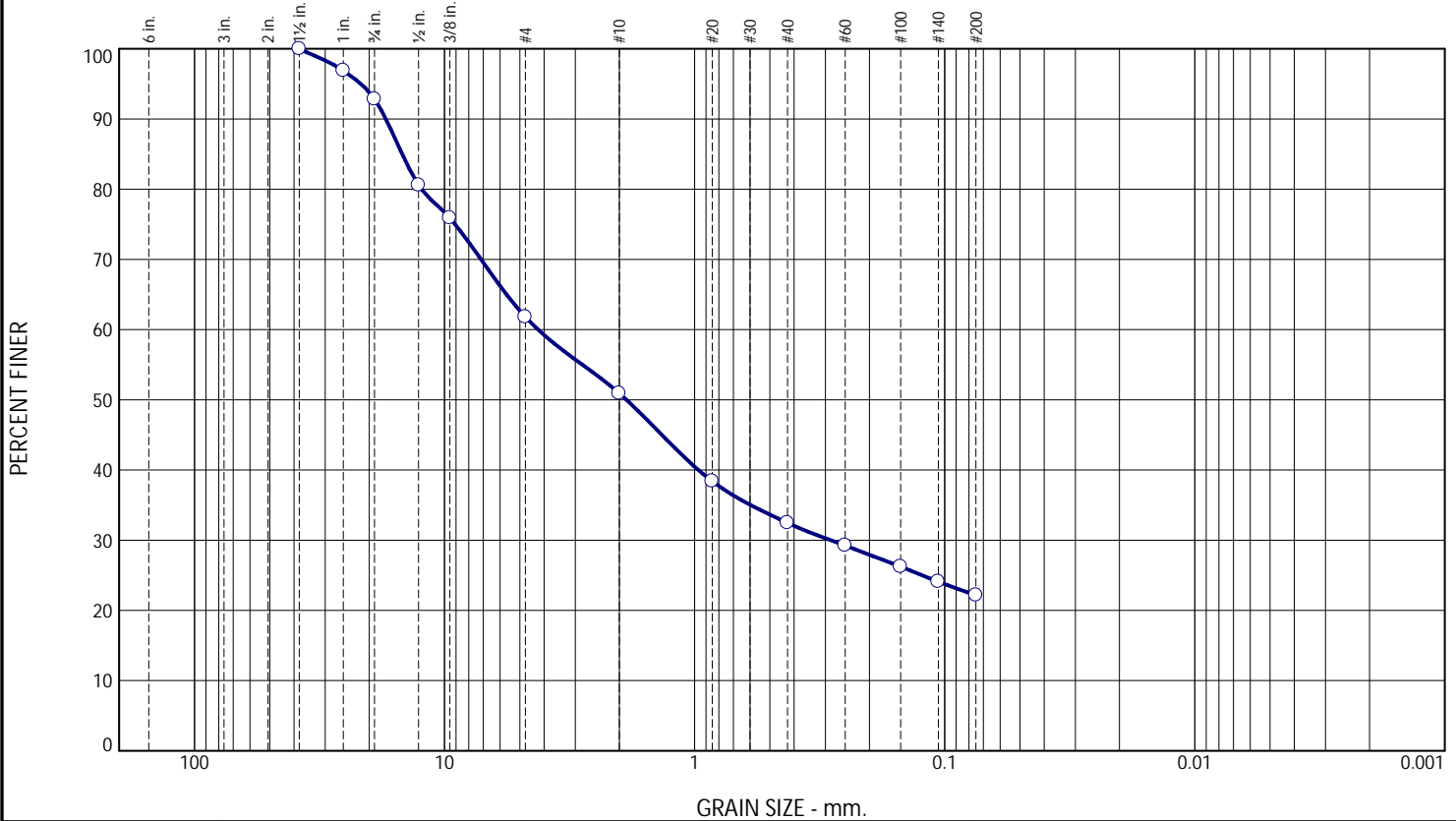
Sample Number: B-16, S-3      Depth: 4'-6'

Date: 8/26/2023

<p><b>ANS CONSULTANTS, INC.</b></p> <p>South Plainfield, New Jersey</p>	<p>Client: Concept Engineering Consultants</p> <p>Project: Clinton Commons, Clinton, NJ</p> <p>Project No: IRN 23-082</p> <p style="text-align: right;">Figure</p>
-------------------------------------------------------------------------	--------------------------------------------------------------------------------------------------------------------------------------------------------------------

Tested By: AA      Checked By: ANS

# Particle Size Distribution Report (ASTM D6913)



% +3"	% Gravel		% Sand			% Fines	
	Coarse	Fine	Coarse	Medium	Fine	Silt	Clay
0.0	7.2	31.0	10.9	18.4	10.4	22.1	

SIEVE SIZE OR DIAMETER	PERCENT FINER	SPEC.* PERCENT	PASS? (X=NO)
1.5"	100.0		
1"	96.9		
3/4"	92.8		
1/2"	80.6		
3/8"	75.9		
#4	61.8		
#10	50.9		
#20	38.4		
#40	32.5		
#60	29.2		
#100	26.2		
#140	24.1		
#200	22.1		

Soil Description

Gray silty sand with gravel

<u>Atterberg Limits</u>		
PL= NP	LL= NV	PI= NP

<u>Coefficients</u>		
D <sub>90</sub> = 17.1607	D <sub>85</sub> = 14.7652	D <sub>60</sub> = 4.2285
D <sub>50</sub> = 1.8743	D <sub>30</sub> = 0.2855	D <sub>15</sub> =
D <sub>10</sub> =	C <sub>u</sub> =	C <sub>c</sub> =

<u>Classification</u>		
USCS= SM	AASHTO=	A-1-b

Remarks

\* (no specification provided)

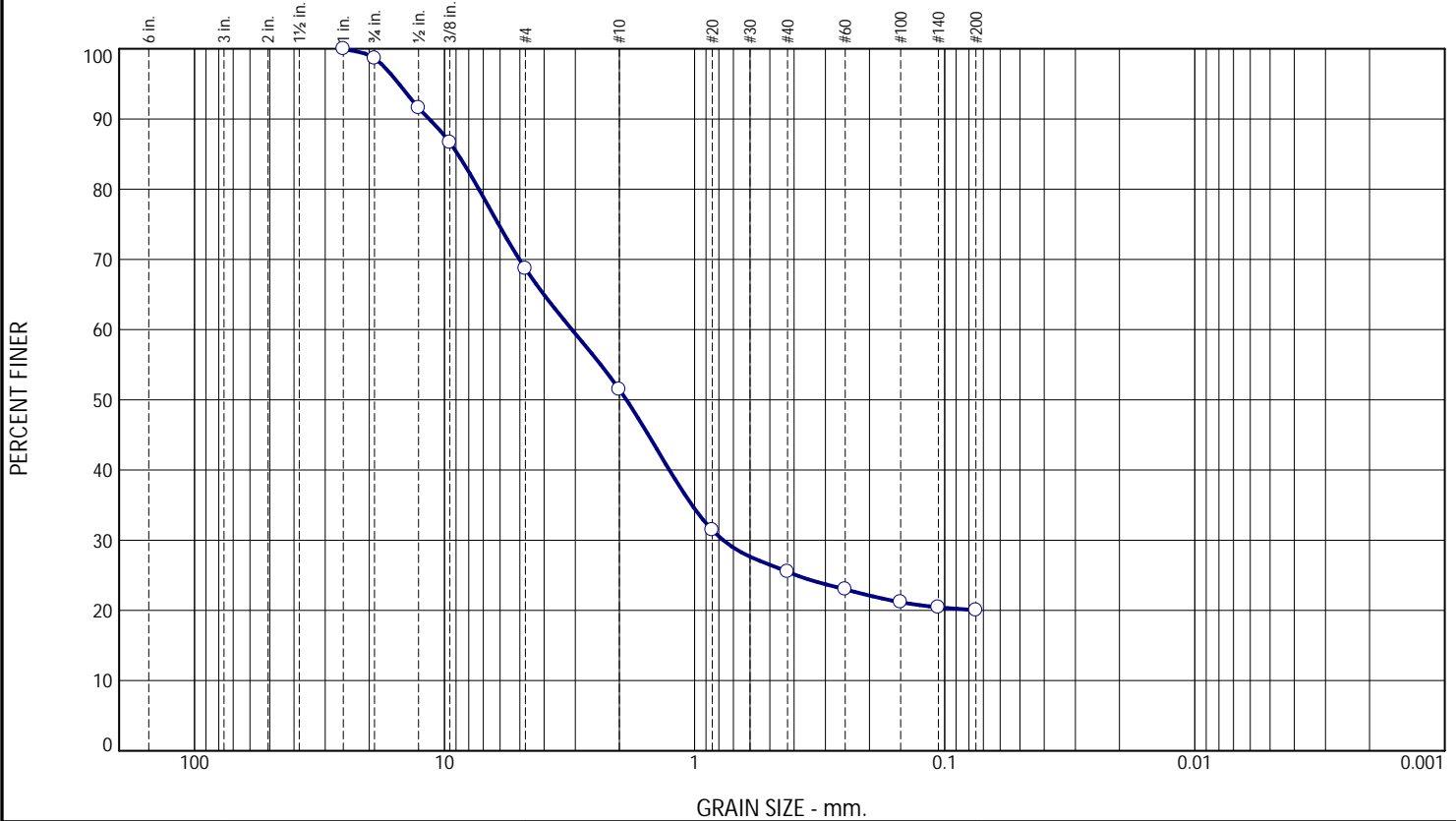
Sample Number: B-17, S-2      Depth: 2'-4'

Date: 8/26/2023

<p style="text-align: center; font-weight: bold; font-size: 1.2em;">ANS CONSULTANTS, INC.</p> <p style="text-align: center;">South Plainfield, New Jersey</p>	<p>Client:    Concept Engineering Consultants</p> <p>Project:    Clinton Commons, Clinton, NJ</p> <p>Project No:    IRN 23-082</p>
<p>Figure</p>	

Tested By: CK      Checked By: ANS

# Particle Size Distribution Report (ASTM D6913)



% +3"	% Gravel		% Sand			% Fines	
	Coarse	Fine	Coarse	Medium	Fine	Silt	Clay
0.0	1.3	30.0	17.2	26.0	5.5	20.0	

SIEVE SIZE OR DIAMETER	PERCENT FINER	SPEC.* PERCENT	PASS? (X=NO)
1"	100.0		
3/4"	98.7		
1/2"	91.6		
3/8"	86.7		
#4	68.7		
#10	51.5		
#20	31.4		
#40	25.5		
#60	23.0		
#100	21.2		
#140	20.4		
#200	20.0		

Soil Description

Grayish Brown silty sand with gravel

PL= NP	<u>Atterberg Limits</u>	PI= NP
	LL= NV	
	<u>Coefficients</u>	
D <sub>90</sub> = 11.5210	D <sub>85</sub> = 8.8499	D <sub>60</sub> = 3.0927
D <sub>50</sub> = 1.8735	D <sub>30</sub> = 0.7684	D <sub>15</sub> =
D <sub>10</sub> =	C <sub>u</sub> =	C <sub>c</sub> =
USCS= SM	<u>Classification</u>	AASHTO= A-1-b
	<u>Remarks</u>	

\* (no specification provided)

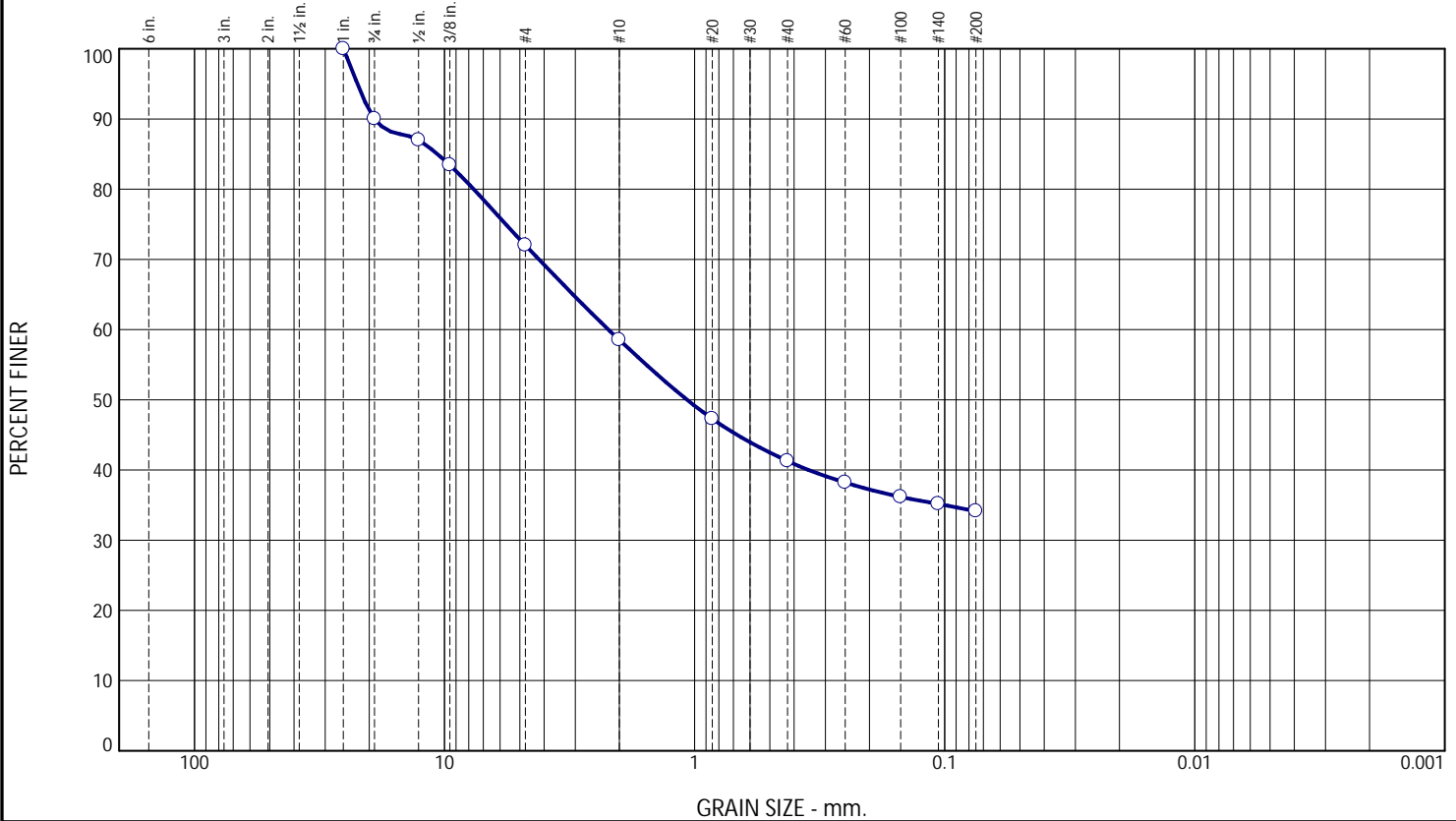
Sample Number: B-18, S-3      Depth: 4'-6'

Date: 8/26/2023

<b>ANS CONSULTANTS, INC.</b>  South Plainfield, New Jersey	Client: Concept Engineering Consultants Project: Clinton Commons, Clinton, NJ  Project No: IRN 23-082
Figure	

Tested By: AA      Checked By: ANS

# Particle Size Distribution Report (ASTM D6913)



% +3"	% Gravel		% Sand			% Fines	
	Coarse	Fine	Coarse	Medium	Fine	Silt	Clay
0.0	10.0	18.0	13.5	17.2	7.2	34.1	

SIEVE SIZE OR DIAMETER	PERCENT FINER	SPEC.* PERCENT	PASS? (X=NO)
1"	100.0		
3/4"	90.0		
1/2"	87.0		
3/8"	83.4		
#4	72.0		
#10	58.5		
#20	47.3		
#40	41.3		
#60	38.2		
#100	36.2		
#140	35.2		
#200	34.1		

Soil Description

Dark Gray silty sand with gravel

PL= NP	<u>Atterberg Limits</u>	PI= NP
	LL= NV	
	<u>Coefficients</u>	
D <sub>90</sub> = 19.0474	D <sub>85</sub> = 10.6719	D <sub>60</sub> = 2.2123
D <sub>50</sub> = 1.0713	D <sub>30</sub> =	D <sub>15</sub> =
D <sub>10</sub> =	C <sub>u</sub> =	C <sub>c</sub> =
	<u>Classification</u>	
USCS= SM	AASHTO=	A-2-4(0)
<u>Remarks</u>		

\* (no specification provided)

Sample Number: B-19, S-2      Depth: 2'-4'

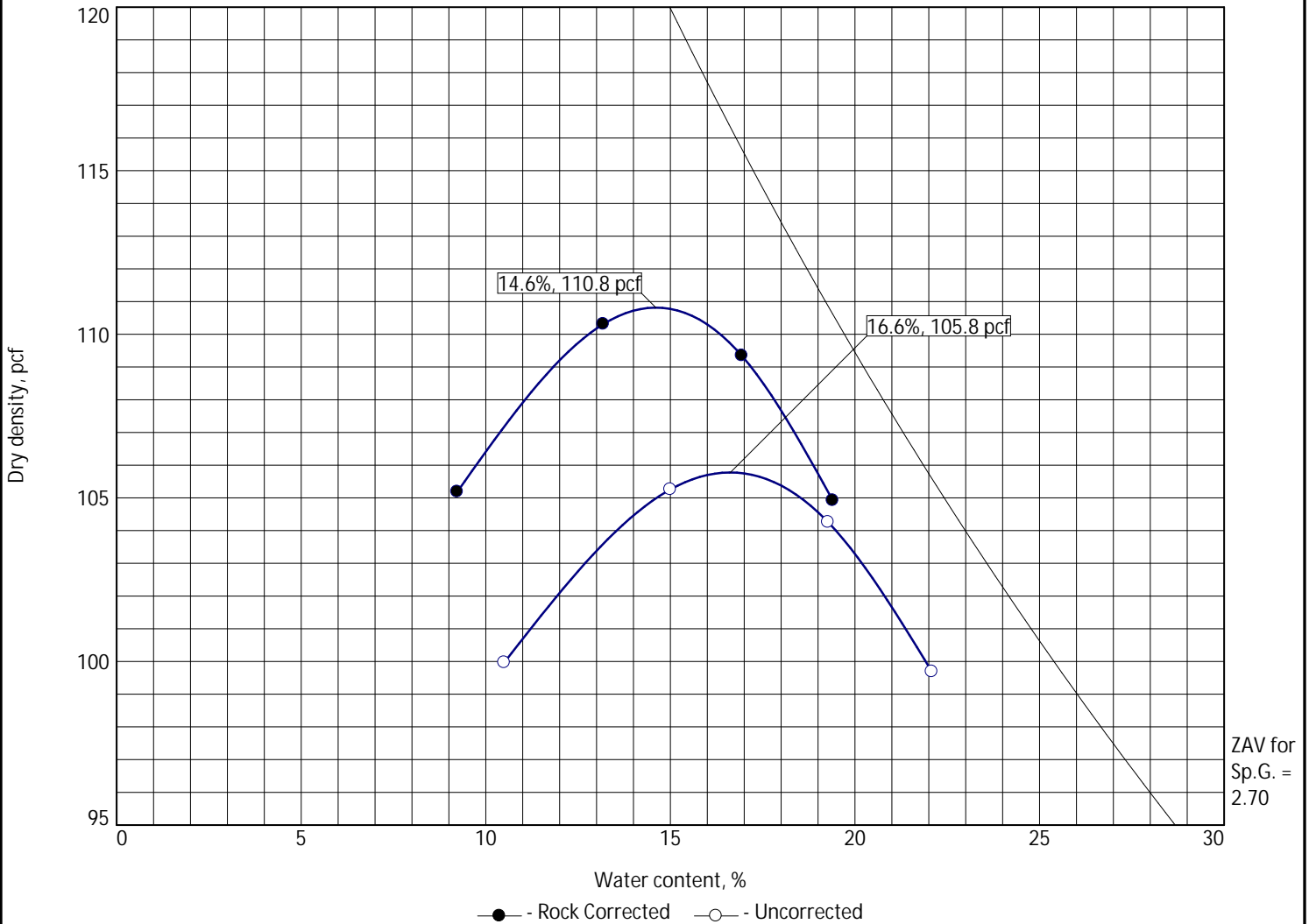
Date:

<b>ANS CONSULTANTS, INC.</b>  South Plainfield, New Jersey	Client:    Concept Engineering Consultants Project:    Clinton Commons, Clinton, NJ  Project No:    IRN 23-082
Figure	

Tested By: AA      Checked By: ANS



# COMPACTION TEST REPORT



Test specification: ASTM D 1557-12 Method B Modified  
 ASTM D4718-15 Oversize Corr. Applied to Each Test Point

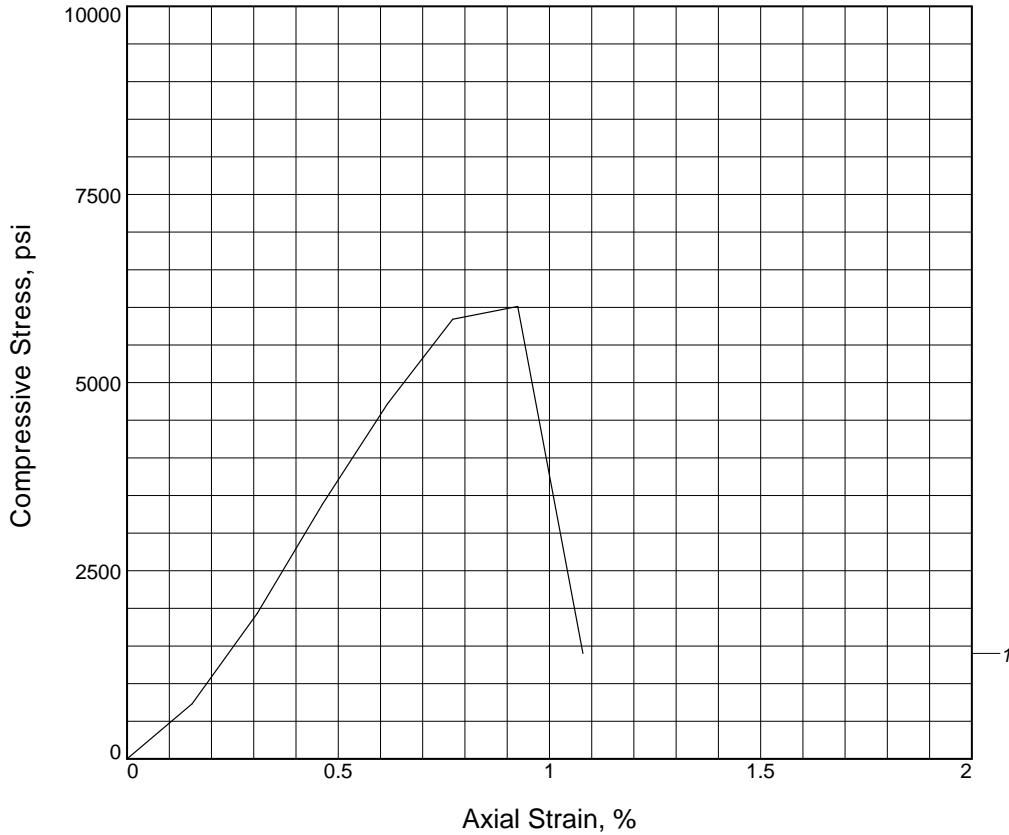
Elev/ Depth	Classification		Nat. Moist.	Sp.G.	LL	PI	% > 3/8 in.	% < No.200
	USCS	AASHTO						
0'-2'				2.7			12.2	

ROCK CORRECTED TEST RESULTS	UNCORRECTED	MATERIAL DESCRIPTION
Maximum dry density = 110.8 pcf	105.8 pcf	Dark Brown Silt & Clay, some mf Gravel, little cmf Sand (Visual, Organics Present)
Optimum moisture = 14.6 %	16.6 %	
Project No. IRN 23-082      Client: Concept Engineering Consultants Project: Clinton Commons, Clinton, NJ Date: 8/26/2023 Sample Number: Bulk, S-1		Remarks: SG Assumed
ANS CONSULTANTS, INC. South Plainfield, New Jersey		

Figure

Tested By: MG                      Checked By: ANS

# UNCONFINED COMPRESSION TEST



Sample No.	1			
Unconfined strength, psi	6012.30			
Undrained shear strength, psi	3006.15			
Failure strain, %	0.9			
Strain rate, in./min.	N/A			
Water content, %	0.0			
Wet density, pcf	171.8			
Dry density, pcf	171.8			
Saturation, %	0.0			
Void ratio	0.0176			
Specimen diameter, in.	1.97			
Specimen height, in.	3.24			
Height/diameter ratio	1.65			


**Description:** Gray Limestone Rock Core

**LL =**      **PL =**      **PI =**      **Assumed GS= 2.8**      **Type:**

<p><b>Project No.:</b> IRN 23-082  <b>Date Sampled:</b> 8/26/2023  <b>Remarks:</b>          ASTM D7012 - Method C          Loading Manner: Constant Stress Rate (0.5 MPa/sec)          H/D Ratio &lt; 2.0</p> <p><b>Figure</b> _____</p>	<p><b>Client:</b> Concept Engineering Consultants  <b>Project:</b> Clinton Commons, Clinton, NJ  <b>Sample Number:</b> B-02, R-1      <b>Depth:</b> 20'8"-21'-3"</p> <p style="text-align: center;">UNCONFINED COMPRESSION TEST          ANS CONSULTANTS, INC.          South Plainfield, New Jersey</p>
--------------------------------------------------------------------------------------------------------------------------------------------------------------------------------------------------------------------------------------------------------------	--------------------------------------------------------------------------------------------------------------------------------------------------------------------------------------------------------------------------------------------------------------------------------------------------------------------------

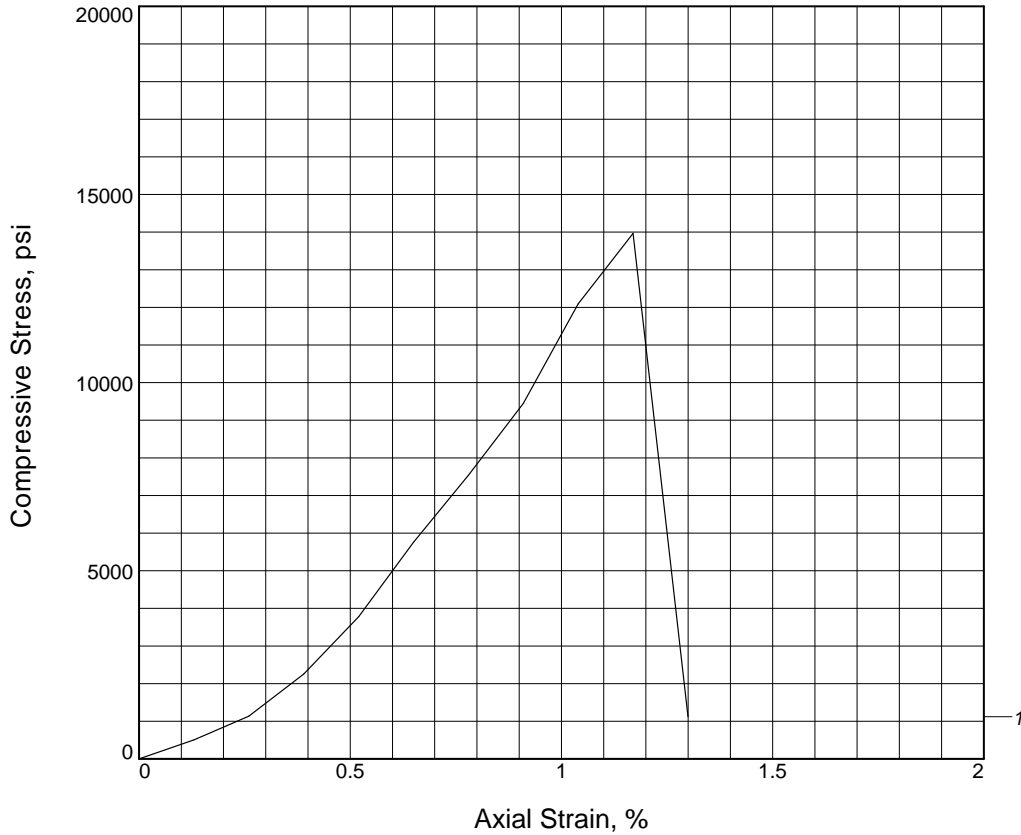
**Tested By:** AS/NK      **Checked By:** ANS





23-082  
B-02, R-1

# UNCONFINED COMPRESSION TEST



Sample No.	1			
Unconfined strength, psi	13965.07			
Undrained shear strength, psi	6982.53			
Failure strain, %	1.2			
Strain rate, in./min.	N/A			
Water content, %	0.0			
Wet density, pcf	172.7			
Dry density, pcf	172.7			
Saturation, %	0.0			
Void ratio	0.0122			
Specimen diameter, in.	1.96			
Specimen height, in.	3.85			
Height/diameter ratio	1.97			

**Description:** Gray Limestone Rock Core

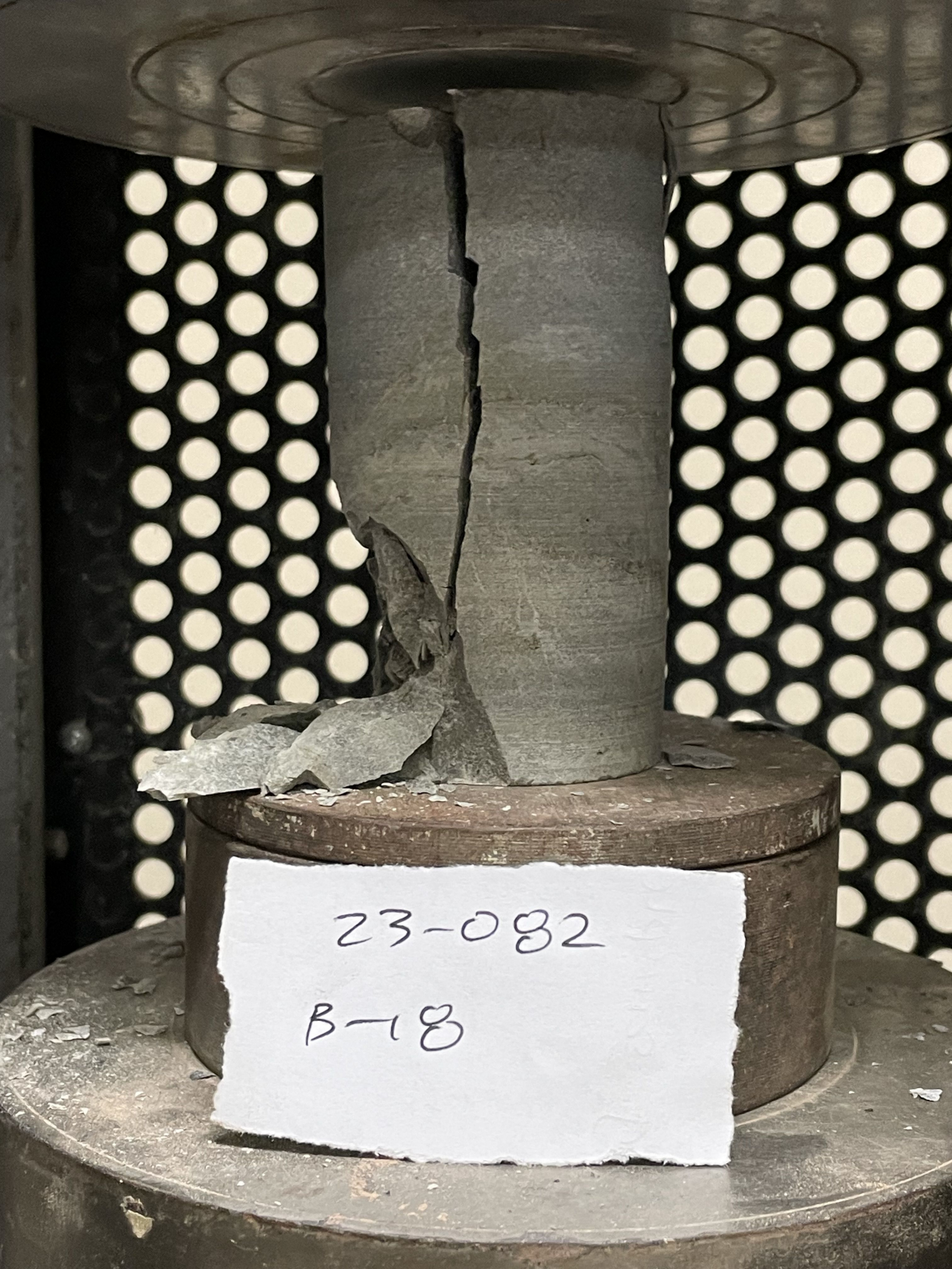
**LL =**      **PL =**      **PI =**      **Assumed GS= 2.8**      **Type:**

**Project No.:** IRN 23-082  
**Date Sampled:** 8/26/2023  
**Remarks:**  
 ASTM D7012 - Method C  
 Loading Manner: Constant Stress Rate (0.5 MPa/sec)  
 H/D Ratio < 2.0  
  
**Figure** \_\_\_\_\_

**Client:** Concept Engineering Consultants  
**Project:** Clinton Commons, Clinton, NJ  
**Sample Number:** B-18      **Depth:** 9'2"  
  
 UNCONFINED COMPRESSION TEST  
 ANS CONSULTANTS, INC.  
 South Plainfield, New Jersey

**Tested By:** AS/NK      **Checked By:** ANS



A cylindrical specimen, possibly made of wood or a similar material, is mounted on a wooden block. The specimen has a prominent vertical crack running down its length. The crack is jagged and appears to have caused some material to splinter or chip away, particularly near the base. The specimen is held in place by a metal ring or collar at the top. The entire assembly is set against a background of a perforated metal screen with a grid of circular holes. A white label with handwritten text is attached to the wooden block.

23-082

B-18

## Appendix E

### Seismic Site Class Data

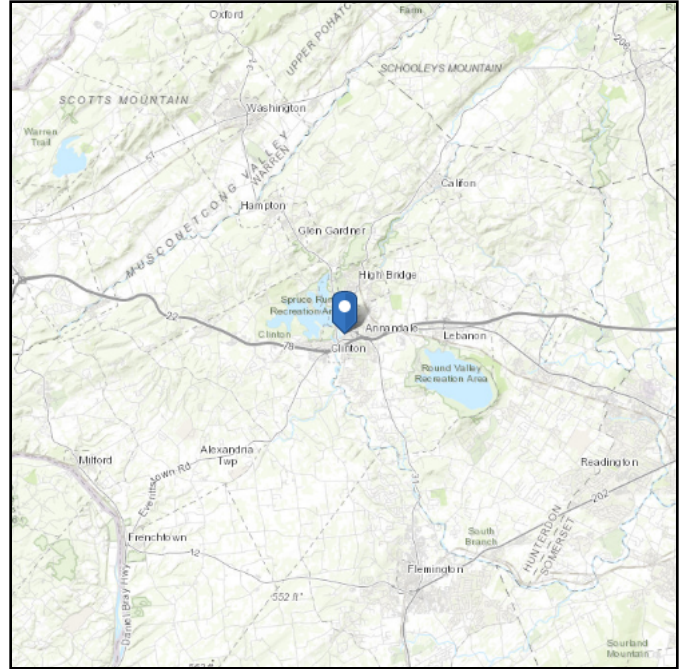
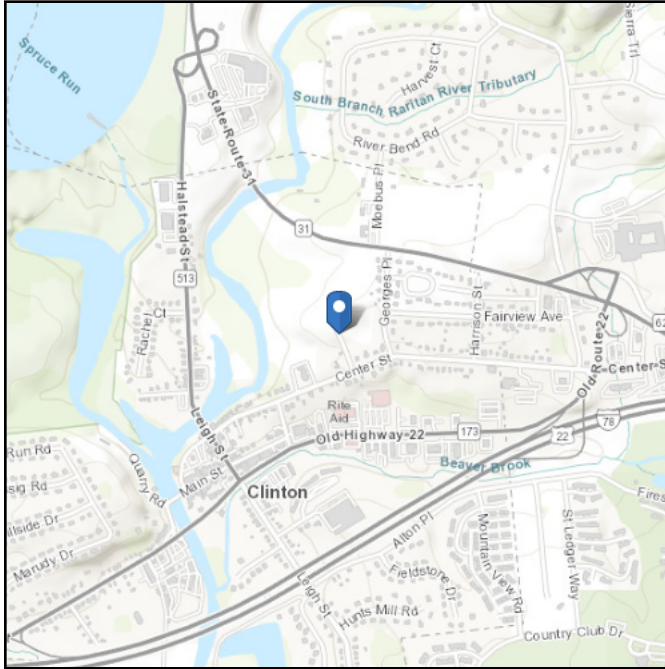


# ASCE 7 Hazards Report

**Address:**  
Central Ave  
Clinton, New Jersey  
08809

**Standard:** ASCE/SEI 7-22  
**Risk Category:** III  
**Soil Class:** C - Very Dense  
Soil and Soft Rock

**Latitude:** 40.64042  
**Longitude:** -74.90622  
**Elevation:** 253.0334333365709 ft  
(NAVD 88)

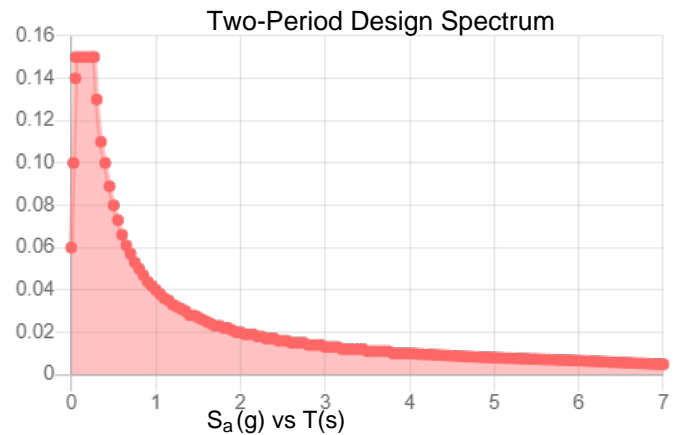
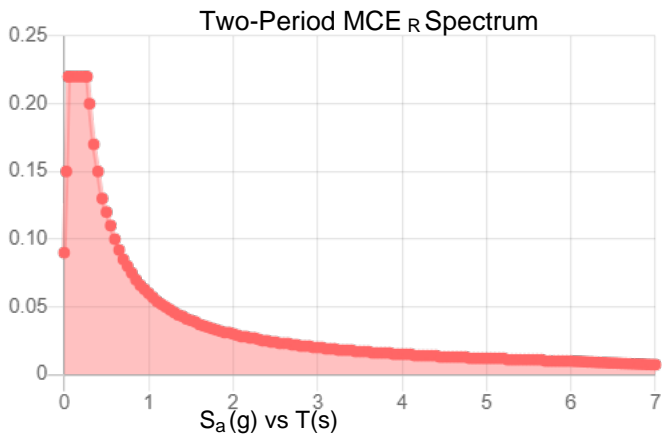
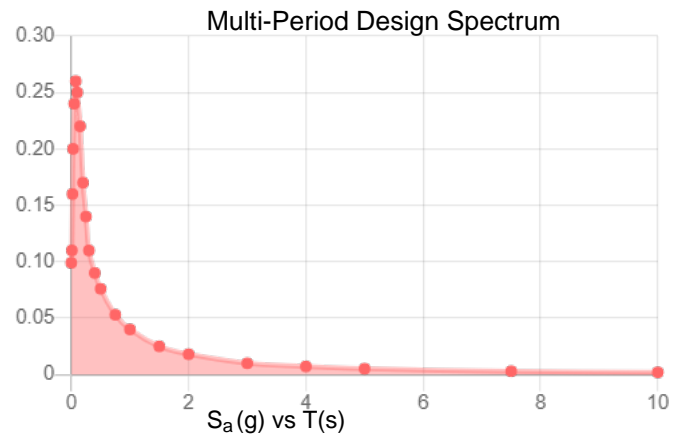
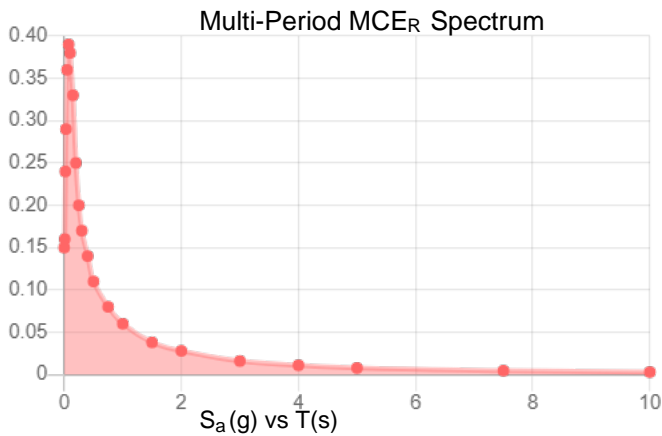


**Site Soil Class:**

**Results:**

PGA <sub>M</sub> :	0.13	T <sub>L</sub> :	6
S <sub>MS</sub> :	0.22	S <sub>S</sub> :	0.22
S <sub>M1</sub> :	0.06	S <sub>1</sub> :	0.047
S <sub>DS</sub> :	0.15	V <sub>S30</sub> :	530
S <sub>D1</sub> :	0.04		

**Seismic Design Category: A**



MCE<sub>R</sub> Vertical Response Spectrum

Vertical ground motion data has not yet been made available by USGS.

Design Vertical Response Spectrum

Vertical ground motion data has not yet been made available by USGS.





**Data Accessed:** Thu Aug 17 2023

**Date Source:**

**USGS Seismic Design Maps based on ASCE/SEI 7-22 and ASCE/SEI 7-22 Table 1.5-2. Additional data for site-specific ground motion procedures in accordance with ASCE/SEI 7-22 Ch. 21 are available from USGS.**

The ASCE 7 Hazard Tool is provided for your convenience, for informational purposes only, and is provided “as is” and without warranties of any kind. The location data included herein has been obtained from information developed, produced, and maintained by third party providers; or has been extrapolated from maps incorporated in the ASCE 7 standard. While ASCE has made every effort to use data obtained from reliable sources or methodologies, ASCE does not make any representations or warranties as to the accuracy, completeness, reliability, currency, or quality of any data provided herein. Any third-party links provided by this Tool should not be construed as an endorsement, affiliation, relationship, or sponsorship of such third-party content by or from ASCE.

ASCE does not intend, nor should anyone interpret, the results provided by this Tool to replace the sound judgment of a competent professional, having knowledge and experience in the appropriate field(s) of practice, nor to substitute for the standard of care required of such professionals in interpreting and applying the contents of this Tool or the ASCE 7 standard.

In using this Tool, you expressly assume all risks associated with your use. Under no circumstances shall ASCE or its officers, directors, employees, members, affiliates, or agents be liable to you or any other person for any direct, indirect, special, incidental, or consequential damages arising from or related to your use of, or reliance on, the Tool or any information obtained therein. To the fullest extent permitted by law, you agree to release and hold harmless ASCE from any and all liability of any nature arising out of or resulting from any use of data provided by the ASCE 7 Hazard Tool.

## Appendix F

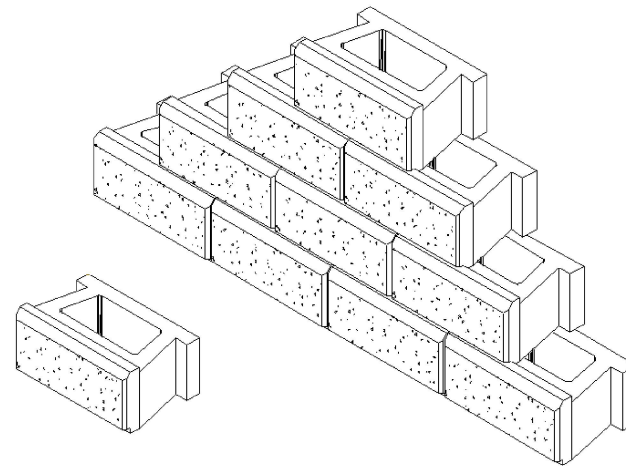
### Retaining Wall Design

# clinton commons

65 1/2 Center Street  
Hunderdon, NJ

## Page Index

- 1 Specifications
- 13 General Notes
- 15 Plan View
- 16 Elevation View
- 21 Section View External Calculations
- 39 Construction Details
- 45 Worksheet



**AB Classic**

I hereby certify that these calculations were prepared by me or under my direct supervision and that I am a duly licensed engineer certified and responsible for the content of these calculations.

Signature:

Engineer: James Brown

24GE03107100 Date:

Project Name: clinton commons  
Location: 65 1/2 Center Street  
Location: Hunderdon, NJ  
Wall Number: 4  
Project Number:  
Designer: Bern Oles  
Date: 4 18 22



# Specification Guidelines: Allan Block Modular Retaining Wall Systems

The following specifications provide Allan Block Corporation's typical requirements and recommendations. At the engineer of record's discretion these specifications may be revised to accommodate site specific design requirements.

## SECTION 1: ALLAN BLOCK MODULAR RETAINING WALL SYSTEMS

### PART 1: GENERAL

#### 1.1 Scope

Work includes furnishing and installing modular concrete block retaining wall units to the lines and grades designated on the construction drawings and as specified herein.

#### 1.2 Applicable Sections of Related Work

Section 2: Geogrid Wall Reinforcement

#### 1.3 Reference Standards

- A. ASTM C1372 Standard Specification for Segmental Retaining Wall Units.
- B. ASTM C1262 Evaluating the Freeze thaw Durability of Manufactured CMUs and Related concrete Units
- C. ASTM D698 Moisture Density Relationship for Soils, Standard Method
- D. ASTM D422 Gradation of Soils
- E. ASTM C140 Sample and Testing concrete Masonry Units

#### 1.4 Delivery, Storage, and Handling

- A. Contractor shall check the materials upon delivery to assure proper material has been received.
- B. Contractor shall prevent excessive mud, cementitious material, and like construction debris from coming in contact with the materials.
- C. Contractor shall protect the materials from damage. Damaged material shall not be incorporated in the project (ASTM C1372).

#### 1.5 Contractor Requirements

Contractors shall be trained and certified by local manufacturer or equivalent accredited organization.

- A. Allan Block and NCMA have certification programs that are accredited. Identify when advanced certification levels are appropriate based on complexity and criticality of project application.
- B. Contractors shall provide a list of projects they have completed.

### PART 2: MATERIALS

#### 2.1 Modular Wall Units

- A. Wall units shall be Allan Block Retaining Wall units as produced by a licensed manufacturer.
- B. Wall units shall have minimum 28 day compressive strength of 3000 psi (20.7 MPa) in accordance with ASTM C1372. The concrete units shall have adequate freeze-thaw protection with an average absorption rate in accordance with ASTM C1372 or an average absorption rate of 7.5 lb/ft<sup>3</sup> (120 kg/m<sup>3</sup>) for northern climates and 10 lb/ft<sup>3</sup> (160 kg/m<sup>3</sup>) for southern climates.

I hereby certify that these calculations were prepared by me or under my direct supervision and that I am a duly licensed engineer certified and responsible for the content of these calculations.

Signature:

Engineer: James Brown

24GE03107100 Date:

Project Name: clinton commons  
Location: 65 1/2 Center Street  
Location: Hunderdon, NJ  
Wall Number: 4  
Project Number:  
Designer: Bern Oles  
Date: 4 18 22

Page #:

1

- C. Exterior dimensions shall be uniform and consistent. Maximum dimensional deviations on the height of any two units shall be 0.125 in. (3 mm).
- D. Wall units shall provide a minimum of 110 lbs total weight per square foot of wall face area (555 kg/m<sup>2</sup>). Hollow cores to be filled with wall rock and compacted by using plate compactor on top of wall units (see Section 3.4). Unit weight of wall rock may be less than 100% depending on compaction levels.
- E. Exterior face shall be textured. Color as specified by owner.
- F. Freeze Thaw Durability: Like all concrete products, dry-cast concrete SRW units are susceptible to freeze-thaw degradation with exposure to de-icing salts and cold temperature. This is a concern in northern tier states or countries that use deicing salts. Based on good performance experience by several agencies, ASTM C1372 or equivalent governing standard or public authority, Standard Specification for Segmental Retaining Wall Units should be used as a model, except that, to increase durability, the compressive strength for the units should be increased to a minimum of 4,000 - 5,800 psi (28 - 40 MPa) unless local requirements dictate higher levels. Also, maximum water absorption should be reduced and requirements for freeze-thaw testing increased.
  - a. Require a current passing ASTM C 1262 or equivalent governing standard or public authority, test report from material supplier in northern or cold weather climates.
  - b. See the Allan Block Best Practices for SRW Design document for detailed information on freeze thaw durability testing criteria and regional temperature and exposure severity figures and tables to define the appropriate zone and requirements for the project.

**2.2 Wall Rock**

- A. Material must be well-graded compactable aggregate, 0.25 in. to 1.5 in., (6 mm - 38 mm) with no more than 10% passing the #200 sieve (ASTM D422).
- B. Material behind and within the blocks may be the same material.

**2.3 Infill Soil**

- A. Infill material shall be site excavated soils when approved by the on-site soils engineer unless otherwise specified in the drawings. Unsuitable soils for backfill (heavy clays or organic soils) shall not be used in the reinforced soil mass. Fine grained cohesive soils with friction angle ( $\phi$ ) less than 31 degrees with a PI range between 6 and 20 and LL from 30 to 40, may be used in wall construction, but additional backfilling, compaction and water management efforts are required. Poorly graded sands, expansive clays and/or soils with a plasticity index (PI) greater than 20 or a liquid limit (LL) greater than 40 should not be used in wall construction.
- B. The infill soil used must meet or exceed the designed friction angle and description noted on the design cross sections, and must be free of debris and consist of one of the following inorganic USCS soil types: GP, GW, SW, SP, GP-GM or SP-SM meeting the following gradation as determined in accordance with ASTM D422.

Sieve Size	Percent Passing
1 inch (25 mm)	100 - 75
No. 4 (4.75 mm)	100 - 20
No. 40 (0.425 mm)	0 - 60
No. 200 (0.075 mm)	0 - 35

- C. Where additional fill is required, contractor shall submit sample and specifications to the wall design engineer or the onsite soils engineer for approval and the approving engineer must certify that the soils proposed for use has properties meeting or exceeding original design standards.

**PART 3: WALL CONSTRUCTION**

I hereby certify that these calculations were prepared by me or under my direct supervision and that I am a duly licensed engineer certified and responsible for the content of these calculations.

Signature:

Engineer: James Brown

24GE03107100 Date:

Project Name: clinton commons  
 Location: 65 1/2 Center Street  
 Location: Hunderdon, NJ  
 Wall Number: 4  
 Project Number:  
 Designer: Bern Oles  
 Date: 4 18 22

Page #:

2

**3.1 Excavation**

- A. Contractor shall excavate to the lines and grades shown on the construction drawings. Contractor shall use caution not to over-excavate beyond the lines shown, or to disturb the base elevations beyond those shown.
- B. Contractor shall verify locations of existing structures and utilities prior to excavation. Contractor shall ensure all surrounding structures are protected from the effects of wall excavation.

**3.2 Foundation Soil Preparation**

- A. Foundation soil shall be defined as any soils located beneath a wall.
- B. Foundation soil shall be excavated as dimensioned on the plans and compacted to a minimum of 95% of Standard Proctor (ASTM D698) prior to placement of the base material.
- C. Foundation soil shall be examined by the on-site soils engineer to ensure that the actual foundation soil strength meets or exceeds assumed design strength. Soil not meeting the required strength shall be removed and replaced with acceptable material.

**3.3 Base**

- A. The base material shall be the same as the Wall Rock material (Section 2.2) or a low permeable granular material.
- B. Base material shall be placed as shown on the construction drawing. Top of base shall be located to allow bottom wall units to be buried to proper depths as per wall heights and specifications.
- C. Base material shall be installed on undisturbed native soils or suitable replacement fills compacted to a minimum of 95% Standard Proctor (ASTM D698).
- D. Base shall be compacted at 95% Standard Proctor (ASTM D698) to provide a level hard surface on which to place the first course of blocks. The base shall be constructed to ensure proper wall embedment and the final elevation shown on the plans. Well-graded sand can be used to smooth the top 1/2 in. (13 mm) on the base material.
- E. Base material shall be a 4 in. (100 mm) minimum depth for walls under 4 ft (1.2 m) and a 6 in. (150 mm) minimum depth for walls over 4 ft (1.2 m).

**3.4 Unit Installation**

- A. Install units in accordance with the manufacturer's instructions and recommendations for the specific concrete retaining wall unit, and as specified herein.
- B. Ensure that units are in full contact with base. Proper care shall be taken to develop straight lines and smooth curves on base course as per wall layout.
- C. Fill all cores and cavities and a minimum of 12 in. (300 mm) behind the base course with wall rock. Use infill soils behind the wall rock and approved soils in front of the base course to firmly lock in place. Check again for level and alignment. Use a plate compactor to consolidate the area behind the base course. All excess material shall be swept from top of units.
- D. Install next course of wall units on top of base course. Position blocks to be offset from seams of blocks below. Perfect running bond is not essential, but a 3 in. (75 mm) minimum offset is recommended. Check each block for proper alignment and level. Fill all cavities in and around wall units and to a minimum of 12 in. (300 mm) depth behind block with wall rock. Block, wall rock and infill soil placed in uniform lifts not exceeding 8 in. (200 mm). Compaction requirements for all soils in areas in, around and behind the reinforced mass shall be compacted to 95% of maximum Standard Proctor dry density (ASTM D698) with a moisture content control of +1% to -3% of optimum.

I hereby certify that these calculations were prepared by me or under my direct supervision and that I am a duly licensed engineer certified and responsible for the content of these calculations.

Signature:

Engineer: James Brown

24GE03107100 Date:

Project Name: clinton commons  
 Location: 65 1/2 Center Street  
 Location: Hunderdon, NJ  
 Wall Number: 4  
 Project Number:  
 Designer: Bern Oles  
 Date: 4 18 22

Page #:

3

E. For taller wall applications, structural fill should be specified for a minimum bottom 1/3 to 1/2 of the reinforced fill. If structural fill is not utilized in the reinforced mass, the depth of wall rock behind the block should be increased. See the Best Practices for SRW Design document for more information.

F. The consolidation zone shall be defined as 3 ft (0.9 m) behind the wall. Compaction within the consolidation zone shall be accomplished by using a hand operated plate compactor and shall begin by running the plate compactor directly on the block and then compacting in parallel paths from the wall face until the entire consolidation zone has been compacted. A minimum of two passes of the plate compactor are required with maximum lifts of 8 in. (200 mm). Expansive or fine-grained soils may require additional compaction passes and/or specific compaction equipment such as a sheepfoot roller. Maximum lifts of 4 inches (100 mm) may be required to achieve adequate compaction within the consolidation zone. Employ methods using lightweight compaction equipment that will not disrupt the stability or batter of the wall. Final compaction requirements in the consolidation zone shall be established by the engineer of record.

G. Install each subsequent course in like manner. Repeat procedure to the extent of wall height.  
Individual course height may vary due to allowable block manufacturing tolerances per ATSM C1372. Contractor must verify wall height, if noted as being critical, prior to completion of construction to ensure the elevation of the top of the wall or the controlling elevation matches desired plan elevation, if noted as critical. Contractor must follow this method for single walls or walls that branch off into a terraced orientation.

H. As with any construction work, some deviation from construction drawing alignments will occur. Variability in construction of SRWs is approximately equal to that of cast-in-place concrete retaining walls. As opposed to cast-in-place concrete walls, alignment of SRWs can be simply corrected or modified during construction. Based upon examination of numerous completed SRWs, the following recommended minimum tolerances can be achieved with good construction techniques.

- Vertical Control - +-1.25 in. (32 mm) max. over 10 ft (3 m) distance
- Horizontal Location Control - straight lines +-1.25 in. (32 mm) over a 10 ft (3 m) distance.
- Rotation - from established plan wall batter: 2.0 Deg.

**3.5 Additional Construction Notes**

A. When one wall branches into two terraced walls, it is important to note that the soil behind the lower wall is also the foundation soil beneath the upper wall. This soil shall be compacted to a minimum of 95% of Standard Proctor (ASTM D698) prior to placement of the base material. Achieving proper compaction in the soil beneath an upper terrace prevents settlement and deformation of the upper wall. One way is to replace the soil with wall rock and compact in 8 in. (200 mm) lifts. When using on-site soils, compact in maximum lifts of 4 in. (100 mm) or as required to achieve specified compaction.

B. Vertical filter fabric use is not suggested for use with cohesive soils. Clogging of such fabric creates unacceptable hydrostatic pressures in soil reinforced structures. When filtration is deemed necessary in cohesive soils, use a three dimensional filtration system of clean sand or filtration aggregate. Vertical filter fabric may be used to separate the wall rock zone from fine grained, sandy infill soils if the design engineer deems it necessary based on potential water migration from above or below grade, through the reinforced zone into the wall rock on the project. Horizontal filter fabric should be placed above the wall rock column to prevent soils from migrating into the wall rock column.

C. Embankment protection fabric is used to stabilize rip rap and foundation soils in water applications and to separate infill materials from the retained soils. This fabric should permit the passage of fines to preclude clogging of the material. Embankment protection fabric shall be a high strength polypropylene monofilament material designed to meet or exceed typical Corps of Engineers plastic filter fabric specifications (CW-02215); stabilized against ultraviolet (UV) degradation and typically exceeding the values in Table 1, page 7 of the AB Spec Book.

I hereby certify that these calculations were prepared by me or under my direct supervision and that I am a duly licensed engineer certified and responsible for the content of these calculations.

Signature:

Engineer: James Brown

24GE03107100 Date:

Project Name: clinton commons  
Location: 65 1/2 Center Street  
Location: Hunderdon, NJ  
Wall Number: 4  
Project Number:  
Designer: Bern Oles  
Date: 4 18 22

Page #:

4



D. Water management is of extreme concern during and after construction. Steps must be taken to ensure that drain pipes are properly installed and vented to daylight or connected to an underground drainage system and a grading plan has been developed that routes water away from the retaining wall location. Site water management is required both during construction of the wall and after completion of construction.

I hereby certify that these calculations were prepared by me or under my direct supervision and that I am a duly licensed engineer certified and responsible for the content of these calculations.

Signature:

Engineer: James Brown

24GE03107100 Date:

Project Name: clinton commons  
Location: 65 1/2 Center Street  
Location: Hunderdon, NJ  
Wall Number: 4  
Project Number:  
Designer: Bern Oles  
Date: 4 18 22

Page #:

5

# Specification Guidelines: Geogrid Reinforcement Systems

The following specifications provide Allan Block Corporation's typical requirements and recommendations. At the engineer of record's discretion these specifications may be revised to accommodate site specific design requirements.

## SECTION 2

### PART 1: GENERAL

#### 1.1 Scope

Work includes furnishing and installing geogrid reinforcement, wall block, and backfill to the lines and grades designated on the construction drawings and as specified herein.

#### 1.2 Applicable Sections of Related Work

Section 1: Allan Block Modular Retaining Wall Systems.

#### 1.3 Reference Standards

See specific geogrid manufacturer's reference standards. Additional Standards:

- A. ASTM D4595 - Tensile Properties of Geotextiles by the Wide-Width Strip Method
- B. ASTM D5262 - Test Method for Evaluating the Unconfined Creep Behavior of Geogrids
- C. ASTM D6638 Grid Connection Strength (SRW-U1)
- D. ASTM D6916 SRW Block Shear Strength (SRW-U2)
- E. GRI-GG4 - Grid Long Term Allowable Design Strength (LTADS)
- F. ASTM D6706 - Grid Pullout of Soil

#### 1.4 Delivery, Storage, and Handling

- A. Contractor shall check the geogrid upon delivery to assure that the proper material has been received.
- B. Geogrid shall be stored above -10 F (-23 C).
- C. Contractor shall prevent excessive mud, cementitious material, or other foreign materials from coming in contact with the geogrid material.

### PART 2: MATERIALS

#### 2.1 Definitions

- A. Geogrid products shall be of high density polyethylene or polyester yarns encapsulated in a protective coating specifically fabricated for use as a soil reinforcement material.
- B. Concrete retaining wall units are as detailed on the drawings and shall be Allan Block Retaining Wall Units.
- C. Drainage material is free draining granular material as defined in Section 1, 2.2 Wall Rock.
- D. Infill soil is the soil used as fill for the reinforced soil mass.
- E. Foundation soil is the in-situ soil.

#### 2.2 Products

I hereby certify that these calculations were prepared by me or under my direct supervision and that I am a duly licensed engineer certified and responsible for the content of these calculations.

Signature:

Engineer: James Brown

24GE03107100 Date:

Project Name: clinton commons  
Location: 65 1/2 Center Street  
Location: Hunderdon, NJ  
Wall Number: 4  
Project Number:  
Designer: Bern Oles  
Date: 4 18 22

Page #:

6

Geogrid shall be the type as shown on the drawings having the property requirements as described within the manufacturer's specifications.

**2.3 Acceptable Manufacturers**

A manufacturer's product shall be approved by the wall design engineer.

**PART 3: WALL CONSTRUCTION**

**3.1 Foundation Soil Preparation**

- A. Foundation soil shall be excavated to the lines and grades as shown on the construction drawings, or as directed by the on-site soils engineer.
- B. Foundation soil shall be examined by the on-site soils engineer to assure that the actual foundation soil strength meets or exceeds assumed design strength.
- C. Over-excavated areas shall be filled with compacted backfill material approved by on-site soils engineer.
- D. Contractor shall verify locations of existing structures and utilities prior to excavation. Contractor shall ensure all surrounding structures are protected from the effects of wall excavation.

**3.2 Wall Construction**

Wall construction shall be as specified under Section 1, Part 3, Wall Construction.

**3.3 Geogrid Installation**

- A. Install Allan Block wall to designated height of first geogrid layer. Backfill and compact the wall rock and infill soil in layers not to exceed 8 in. (200 mm) lifts behind wall to depth equal to designed grid length before grid is installed.
- B. Cut geogrid to designed embedment length and place on top of Allan Block to back edge of the raised front lip or within 1 in. (25 mm) of the concrete retaining wall face when using AB Fieldstone. Extend away from wall approximately 3% above horizontal on compacted infill soils.
- C. Lay geogrid at the proper elevation and orientations shown on the construction drawings or as directed by the wall design engineer.
- D. Correct orientation of the geogrid shall be verified by the contractor and on-site soils engineer. Strength direction is typically perpendicular to wall face.
- E. Follow manufacturer's guidelines for overlap requirements. In curves and corners, layout shall be as specified in Design Detail 9-12: Using Grid with Corners and Curves, see page 14 of the AB Spec Book.
- F. Place next course of Allan Block on top of grid and fill block cores with wall rock to lock in place. Remove slack and folds in grid and stake to hold in place.
- G. Adjacent sheets of geogrid shall be butted against each other at the wall face to achieve 100 percent coverage.
- H. Geogrid lengths shall be continuous. Splicing parallel to the wall face is not allowed.

**3.4 Fill Placement**

- A. Infill soil shall be placed in lifts and compacted as specified under Section 1, Part 3.4, Unit Installation.
- B. Infill soil shall be placed, spread and compacted in such a manner that minimizes the development of slack or movement of the geogrid.

I hereby certify that these calculations were prepared by me or under my direct supervision and that I am a duly licensed engineer certified and responsible for the content of these calculations.

Signature:

Engineer: James Brown

24GE03107100 Date:

Project Name: clinton commons  
Location: 65 1/2 Center Street  
Location: Hunderdon, NJ  
Wall Number: 4  
Project Number:  
Designer: Bern Oles  
Date: 4 18 22

Page #:

7

C. Only hand-operated compaction equipment shall be allowed within 3 ft (0.9 m) behind the wall. This area shall be defined as the consolidation zone. Compaction in this zone shall begin by running the plate compactor directly on the block and then compacting in parallel paths to the wall face until the entire consolidation zone has been compacted. A minimum of two passes of the plate compactor are required with maximum lifts of 8 in. (200 mm). Section 1, Part 3.4 F, Page 3 of the AB Spec Book.

D. When fill is placed and compaction cannot be defined in terms of Standard Proctor Density, then compaction shall be performed using ordinary compaction process and compacted so that no deformation is observed from the compaction equipment or to the satisfaction of the engineer of record or the site soils engineer.

E. Tracked construction equipment shall not be operated directly on the geogrid. A minimum fill thickness of 6 in. (150 mm) is required prior to operation of tracked vehicles over the geogrid. Turning of tracked vehicles should be kept to a minimum to prevent tracks from displacing the fill and damaging the geogrid.

F. Rubber-tired equipment may pass over the geogrid reinforcement at slow speeds, less than 10 mph (16 Km/h). Sudden braking and sharp turning shall be avoided.

G. The infill soil shall be compacted to achieve 95% Standard Proctor (ASTM D698). Soil tests of the infill soil shall be submitted to the on-site soils engineer for review and approval prior to the placement of any material. The contractor is responsible for achieving the specified compaction requirements. The on-site soils engineer may direct the contractor to remove, correct or amend any soil found not in compliance with these written specifications.

H. An independent testing firm should be hired by the owner to provide services.

I. Independent firm to keep inspection log and provide written reports at predetermined intervals to the owner.

J. Testing frequency should be set to establish a proper compaction protocol to consistently achieve the minimum compaction requirements set by the design requirements. If full time inspection and testing at 8 inch (20 cm) lifts is not provided, then the following testing frequency should be followed:

- a. One test for every 8 inches (20 cm) of vertical fill placed and compacted, for every 25 lineal feet (7.6 m) of retaining wall length, starting on the first course of block.
- b. Vary compaction test locations to cover the entire area of reinforced zone; including the area compacted by the hand-operated compaction equipment.
- c. Once protocol is deemed acceptable, testing can be conducted randomly at locations and frequencies determined by the on-site soils engineer.

K. Slopes above the wall must be compacted and checked in a similar manner.

**3.5 Special Considerations**

A. Geogrid can be interrupted by periodic penetration of a column, pier or footing structure.

B. Allan Block walls will accept vertical and horizontal reinforcing with rebar and grout.

C. If site conditions will not allow geogrid embedment length, consider the following alternatives:

Masonry Reinforced Walls - Soil Nailing -Increased Wall Batter - Earth Anchors - Double Allan Block Wall - Rock Bolts -No-Fines Concrete

See Design Details Page 16 and 17 of the AB Spec Book.

D. Allan Block may be used in a wide variety of water applications as indicated in Section 3, Part 1.8.

I hereby certify that these calculations were prepared by me or under my direct supervision and that I am a duly licensed engineer certified and responsible for the content of these calculations.

Signature:

Engineer: James Brown

24GE03107100 Date:

Project Name: clinton commons  
Location: 65 1/2 Center Street  
Location: Hunderdon, NJ  
Wall Number: 4  
Project Number:  
Designer: Bern Oles  
Date: 4 18 22

Page #:

8



# Specification Guidelines: Water Management

The following specifications provide Allan Block Corporation's typical requirements and recommendations. At the engineer of record's discretion these specifications may be revised to accommodate site specific design requirements

## SECTION 3

### PART 1: GENERAL DRAINAGE

#### 1.1 Surface Drainage

Rainfall or other water sources such as irrigation activities collected by the ground surface atop the retaining wall can be defined as surface water. Retaining wall design shall take into consideration the management of this water.

- A. At the end of each day's construction and at final completion, grade the backfill to avoid water accumulation behind the wall or in the reinforced zone.
- B. Surface water must not be allowed to pond or be trapped in the area above the wall or at the toe of the wall.
- C. Existing slopes adjacent to retaining wall or slopes created during the grading process shall include drainage details so that surface water will not be allowed to drain over the top of the slope face and/or wall. This may require a combination of berms and surface drainage ditches.
- D. Irrigation activities at the site shall be done in a controlled and reasonable manner. If an irrigation system is employed, the design engineer or irrigation manufacturer shall provide details and specification for required equipment to ensure against over irrigation which could damage the structural integrity of the retaining wall system.
- E. Surface water that cannot be diverted from the wall must be collected with surface drainage swales and drained laterally in order to disperse the water around the wall structure. Construction of a typical swale system shall be in accordance with Design Detail 5: Swales, of the AB Spec Book.

#### 1.2 Grading

The shaping and re-contouring of land in order to prepare it for site development is grading. Site grading shall be designed to route water around the walls.

- A. Establish final grade with a positive gradient away from the wall structure. Concentrations of surface water runoff shall be managed by providing necessary structures, such as paved ditches, drainage swales, catch basins, etc.
- B. Grading designs must divert sources of concentrated surface flow, such as parking lots, away from the wall.

#### 1.3 Drainage System

The internal drainage systems of the retaining wall can be described as the means of eliminating the buildup of incidental water which infiltrates the soils behind the wall. Drainage system design will be a function of the water conditions on the site. Possible drainage facilities include Toe and Heel drainage collection pipes and blanket or chimney rock drains or others. Design engineer shall determine the required drainage facilities to completely drain the retaining wall structure for each particular site condition.

I hereby certify that these calculations were prepared by me or under my direct supervision and that I am a duly licensed engineer certified and responsible for the content of these calculations.

Signature:

Engineer: James Brown

24GE03107100 Date:

Project Name: clinton commons  
Location: 65 1/2 Center Street  
Location: Hunderdon, NJ  
Wall Number: 4  
Project Number:  
Designer: Bern Oles  
Date: 4 18 22

Page #:

9

- A. All walls will be constructed with a minimum of 12 in. (300 mm) of wall rock directly behind the wall facing. The material shall meet or exceed the specification for wall rock outlined in Section 1, 2.2 Wall Rock.
- B. The drainage collection pipe, drain pipe, shall be a 4 in. (100 mm) perforated or slotted PVC, or corrugated HDPE pipe as approved by engineer of record.
- C. All walls will be constructed with a 4 in. (100 mm) diameter drain pipe placed at the lowest possible elevation within the 12 in. (300 mm) of wall rock. This drain pipe is referred to as a toe drain, Section 3, 1.4 Toe Drain.
- D. Geogrid Reinforced Walls shall be constructed with an additional 4 in. (100 mm) drain pipe at the back bottom of the reinforced soil mass. This drain pipe is referred to as a heel drain, Section 3, 1.5 Heel Drain.

**1.4 Toe Drain**

A toe drain pipe should be located at the back of the wall rock behind the wall as close to the bottom of the wall as allowed while still maintaining a positive gradient for drainage to daylight, or a storm water management system. Toe drains are installed for incidental water management not as a primary drainage system.

- A. For site configurations with bottoms of the base on a level plane it is recommended that a minimum one percent gradient be maintained on the placement of the pipe with outlets on 50 ft (15 m) centers, or 100 ft (30 m) centers if pipe is crowned between the outlets. This would provide for a maximum height above the bottom of the base in a flat configuration of no more than 6 in. (150 mm).
- B. For rigid drain pipes with drain holes the pipes should be positioned with the holes located down. Allan Block does not require that toe drain pipes be wrapped when installed into base rock complying with the specified wall rock material.
- C. Pipes shall be routed to storm drains where appropriate or through or under the wall at low points when the job site grading and site layout allows for routing. Appropriate details shall be included to prevent pipes from being crushed, plugged, or infested with rodents.
- D. On sites where the natural drop in grade exceeds the one percent minimum, drain pipes outlets shall be on 100 foot (30 m) centers maximum. This will provide outlets in the event that excessive water flow exceeds the capacity of pipe over long stretches.
- E. When the drain pipe must be raised to accommodate outlets through the wall face, refer to the Design Detail 4: Alternate Drain, Page 13 of the AB Spec Book

**1.5 Heel Drain**

The purpose of the heel drain is to pick up any water that migrates from behind the retaining wall structure at the cut and route the water away from the reinforced mass during the construction process and for incidental water for the life of the structure.

- A. The piping used at the back of the reinforced mass shall have a one percent minimum gradient over the length, but it is not critical for it to be positioned at the very bottom of the cut. The heel drain should be vented at 100ft (30m) intervals along the entire length of the wall and should not be tied into the toe drain.
- B. The pipe may be a rigid pipe with holes at the bottom with an integral sock encasing the pipe or a corrugated perforated flexible pipe with a sock to filter out fines when required based on soil conditions. For infill soils with a high percentage of sand and/or gravel the heel drain pipe does not need to be surrounded by wall rock. When working with soils containing fine grained cohesive soils having a PI of greater than 6 and LL of 30 or greater, 1 cubic foot (0.03 cubic meter) of drainage rock is required around the pipe for each 1 ft. (30 cm) of pipe length.

**1.6 Ground Water**

I hereby certify that these calculations were prepared by me or under my direct supervision and that I am a duly licensed engineer certified and responsible for the content of these calculations.

Signature:

Engineer: James Brown

24GE03107100 Date:

Project Name: clinton commons  
 Location: 65 1/2 Center Street  
 Location: Hunderdon, NJ  
 Wall Number: 4  
 Project Number:  
 Designer: Bern Oles  
 Date: 4 18 22

Ground water can be defined as water that occurs within the soil. It may be present because of surface infiltration or water table fluctuation. Ground water movement must not be allowed to come in contact with the retaining wall.

- A. If water is encountered in the area of the wall during excavation or construction, a drainage system (chimney, composite or blanket) must be installed as directed by the wall design engineer.
- B. Standard retaining wall designs do not include hydrostatic forces associated with the presence of ground water. If adequate drainage is not provided the retaining wall design must consider the presence of the water.
- C. When non-free draining soils (soils with friction angles less than 30 degrees) are used in the reinforced zone, the incorporation of a chimney and blanket drain should be added to minimize the water penetration into the reinforced mass. Refer to Design Detail 6: Chimney and Blanket Drain, Page 13 of the AB Spec Book.
  - a. Drain material to be consistent with wall rock material. For more information on wall rock material see Specification Guidelines: Allan Block Modular Retaining Wall Systems, section 2.1.
  - b. Manufactured chimney and blanket drains to be approved by the geotechnical and/or the local engineer of record prior to use.

**1.7 Concentrated Water Sources**

All collection devices such as roof downspouts, storm sewers, and curb gutters are concentrated water sources. They must be designed to accommodate maximum flow rates and to vent outside of the wall area.

- A. All roof downspouts of nearby structures shall be sized with adequate capacity to carry storm water from the roof away from the wall area. They shall be connected to a drainage system in closed pipe and routed around the retaining wall area.
- B. Site layout must take into account locations of retaining wall structures and all site drainage paths. Drainage paths should always be away from retaining wall structures.
- C. Storm sewers and catch basins shall be located away from retaining wall structures and designed so as not to introduce any incidental water into the reinforced soil mass.
- D. A path to route storm sewer overflow must be incorporated into the site layout to direct water away from the retaining wall structure.

**1.8 Water Application**

Retaining walls constructed in conditions that allow standing or moving water to come in contact with the wall face are considered water applications. These walls require specific design and construction steps to ensure performance. Refer to Design Detail 7 and 8: Water Applications, Page 13 of the AB Spec Book.

- A. The wall rock should be placed to the limits of the geogrid lengths up to a height equal to 12 inches (30 cm) higher than the determined high water mark. If the high water mark is unknown, the entire infill zone should be constructed with wall rock.
- B. The drain pipe should be raised to the low water elevation to aid in the evacuation of water from the reinforced mass as water level fluctuates.
- C. Embankment protection fabric should be used under the infill mass and up the back of the infill mass to a height of 12 inches (30 cm) higher than the determined high water mark.
  - i.) Embankment protection fabric is used to stabilize rip rap and foundation soils in water applications and to separate infill materials from the retained soils. This fabric should permit the passage of fines to preclude clogging of the material. Embankment protection fabric shall be a high strength polypropylene monofilament material designed to meet or exceed typical NTPEP specifications; stabilized against ultraviolet (UV) degradation and typically meets or exceeds the values in Table 1.

Table 1: Embankment Protection Fabric Specifications

I hereby certify that these calculations were prepared by me or under my direct supervision and that I am a duly licensed engineer certified and responsible for the content of these calculations.

Signature:

Engineer: James Brown

24GE03107100 Date:

Project Name: clinton commons  
 Location: 65 1/2 Center Street  
 Location: Hunderdon, NJ  
 Wall Number: 4  
 Project Number:  
 Designer: Bern Oles  
 Date: 4 18 22

Page #:

11

Mechanical Property _____	Determination Method
Tensile Strength = 225 lbs/ft (39.4 kN/m) _____	ASTM D-4595
Puncture Strength = 950 lbs (4228 N) _____	ASTM D-6241
Apparent Opening Size (AOS) = U,S Sieve #70 (0.212 mm) _____	ASTM D-4751
Trapezoidal Tear = 100 lbs. (445 N) _____	ASTM D-4533
Percent Open Area = 4% _____	COE-02215
Permeability = 0.01 cm/sec _____	ASTM D-4491

D. For walls having moving water or wave action, natural or manufactured rip-rap in front of the wall to protect the toe of the wall from scour effects is recommended.

I hereby certify that these calculations were prepared by me or under my direct supervision and that I am a duly licensed engineer certified and responsible for the content of these calculations.

Signature:

Engineer: James Brown

24GE03107100 Date:

Project Name: clinton commons  
 Location: 65 1/2 Center Street  
 Location: Hunderdon, NJ  
 Wall Number: 4  
 Project Number:  
 Designer: Bern Oles  
 Date: 4 18 22

Page #:

12



# General Notes

## Construction Notes

1 - Soil loading considered in this design and calculations are based on the following parameters:

	Friction Angle	Cohesion	Unit WT	Soil Type
Infill Soil	0 - 30	0	0 - 120	Well compacted silty, sandy clay
Retained Soil	0 - 26	0	0 - 120	Well compacted silty, sandy clay
Foundation Soil	30	0	120	Well compacted silty, sandy clay

2 - Actual soil parameters must meet or exceed these listed conditions to be used in wall construction. In general, granular soils (friction angle greater than or equal to 32 degrees) are recommended as infill soil. Fine grained cohesive soils (friction angle less than 32 degrees) with low plasticity (PI less than 20) may be used in wall construction, but additional backfilling and compaction efforts are required. Allan Block Corporation has not verified these design conditions, and if required the soil parameters shall be confirmed by the Site Geotechnical Engineer or others prior to wall construction.

3 - Substitution of Infill Soils are strictly prohibited unless approved by the engineer of record.

4 - In this analysis, the effective friction angle without the addition of cohesion is used to determine the design strength of the soil when calculating lateral forces. At the discretion of the engineer of record, cohesion may be used when calculating the ultimate bearing capacity even though it is typically ignored.

5 - Global stability and seismic loading are not considered in this design.

6 - Hydrostatic loading is not considered in this analysis. Sufficient drainage must be provided such that hydrostatic loading (pore pressure) does not develop in the reinforced zone.

7 - Analysis assumes fill placement in 8 inch (200 mm) lifts compacted to 95% Standard Proctor Density. For any wall over 10 feet (3 meters), with a surcharge or contains cohesive soils, compaction test frequency and location shall be determined by the engineer of record or as otherwise specified.

8 - All fill placed above walls shall be placed and compacted in accordance with the requirements for all other reinforced material.

9 - Retaining wall units and installation shall conform to the Allan Block Modular Retaining Wall Systems Specification Guidelines, Geogrid Reinforcement Systems Specification Guidelines, and Water Management Specification Guidelines as published in the AB Spec Book and the AB Engineering Manual.

10 - Retaining walls must be installed and constructed according to the contract drawings. The retaining wall plan view is for wall identification only.

11 - Geogrid spacing is determined by structural cross-section design requirements. To insure proper geogrid placement, contractor must review both elevation view and cross sections prior to wall construction.

12 - Suggested Quality Assurance Requirements:

A qualified engineer or technician shall supervise the wall construction to verify field and site soil conditions. In the event that the Site Geotechnical Engineer does not perform this work, a qualified Geotechnical Engineer/Technician shall be consulted to assure the Allan Block Wall is constructed with proper soil parameters.

## Surface Drainage Notes

1 - Rainfall and other water sources such as irrigation activities can be defined as surface water. The retaining wall design shall take into consideration the management of this water.

I hereby certify that these calculations were prepared by me or under my direct supervision and that I am a duly licensed engineer certified and responsible for the content of these calculations.

Signature:

Engineer: James Brown

24GE03107100 Date:

Project Name: clinton commons  
 Location: 65 1/2 Center Street  
 Location: Hunderdon, NJ  
 Wall Number: 4  
 Project Number:  
 Designer: Bern Oles  
 Date: 4 18 22

Page #:

13

- 2 - Site grading shall be designed to route surface water around and away from the wall.
- 3 - The internal drainage system of the retaining wall is designed to remove incidental water that infiltrates into the soil behind the wall. Adequate storm water drainage systems are required to completely drain the area around the retaining wall structure.
- 4 - Drain piping, toe drain, should be located at the back of the rock drain field behind the wall as close to the bottom of the wall as allowed while still maintaining a positive gradient for drainage to daylight, or to a storm water management system.
- 5 - A heel drain may be required at back of the cut to route water away from the reinforced soil mass during the construction process.
- 6 - Ground water can be present within the soil due to surface infiltration or water table fluctuation. If ground water is encountered during construction, an adequate drainage system must be installed or the wall design must consider the presence of water within the soil mass.
- 7 - All water collection devices such as roof downspouts, storm sewers, and curb gutters must be designed to accommodate maximum flow rates and outlet outside the retaining wall area.
- 8 - Retaining walls in conditions that allow standing water to overlap the wall face are considered water applications. These walls require specific design and construction steps to ensure performance.

I hereby certify that these calculations were prepared by me or under my direct supervision and that I am a duly licensed engineer certified and responsible for the content of these calculations.

Signature:

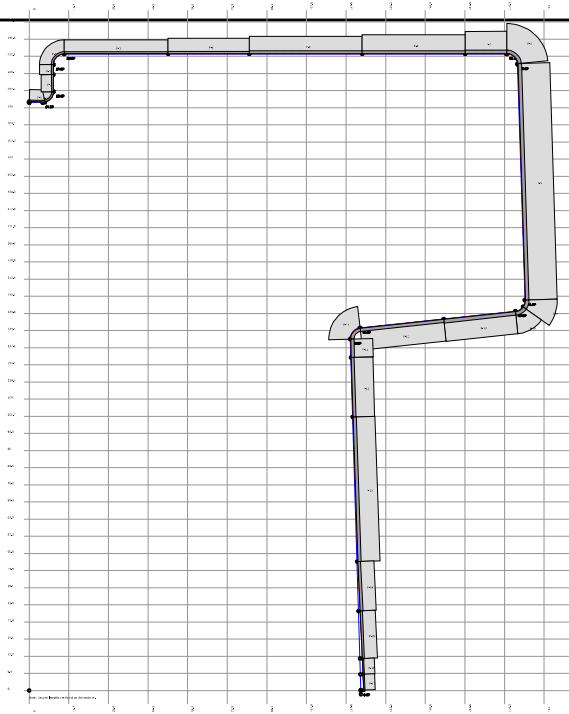
Engineer: James Brown

24GE03107100 Date:

Project Name: clinton commons  
 Location: 65 1/2 Center Street  
 Location: Hunderdon, NJ  
 Wall Number: 4  
 Project Number:  
 Designer: Bern Oles  
 Date: 4 18 22

Page #:

**14**



Panel Key # - Max Grid Length

### Plan View

Note: For specific panel section information, see individual panel sections.

Station	0	1A	1B	2A	2B	3A	3B	4A	4B	5A	5B
x	0	5	9	9	13	177.12	181.12	183.88	180.31	122.68	119.11
y	218	218	222	232	236	236	232.13	144.71	140.6	134.4	130.3
Radius	0	4	0	4	0	4	0	4	0	4	0
Distance	0	5	6.28	10	6.28	164.12	6.16	87.46	5.99	57.96	5.98
Total	0	5	11.28	21.28	27.57	191.69	197.84	285.31	291.29	349.26	355.23

Station
x
y
Radius
Distance
Total
Station
x
y
Radius
Distance
Total

I hereby certify that these calculations were prepared by me or under my direct supervision and that I am a duly licensed engineer certified and responsible for the content of these calculations.

Signature:

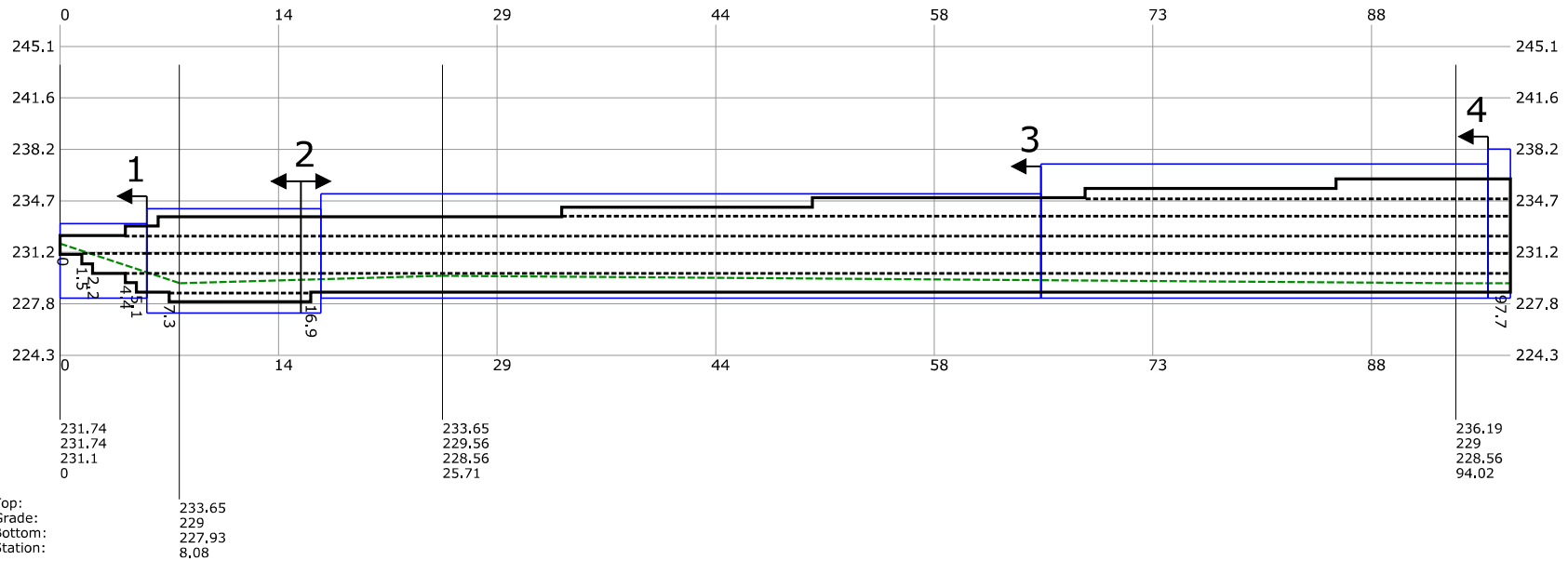
Engineer: James Brown

24GE03107100 Date:

Project Name: clinton commons  
 Location: 65 1/2 Center Street  
 Location: Hunderdon, NJ  
 Wall Number: 4  
 Project Number:  
 Designer: Bern Oles  
 Date: 4 18 22

Page #:

15



### Elevation View

Section	1	2	3	4	5
Top	233.01	233.65	234.92	236.19	237.46
Grade	229.74	229.26	229.23	229	229
Bottom	228.56	227.93	228.56	228.56	228.56
Sta. Cut	5.88	16.16	66.1	96.22	138.09
Sta. End	5.88	17.63	66.1	96.22	138.09

I hereby certify that these calculations were prepared by me or under my direct supervision and that I am a duly licensed engineer certified and responsible for the content of these calculations.

Signature:

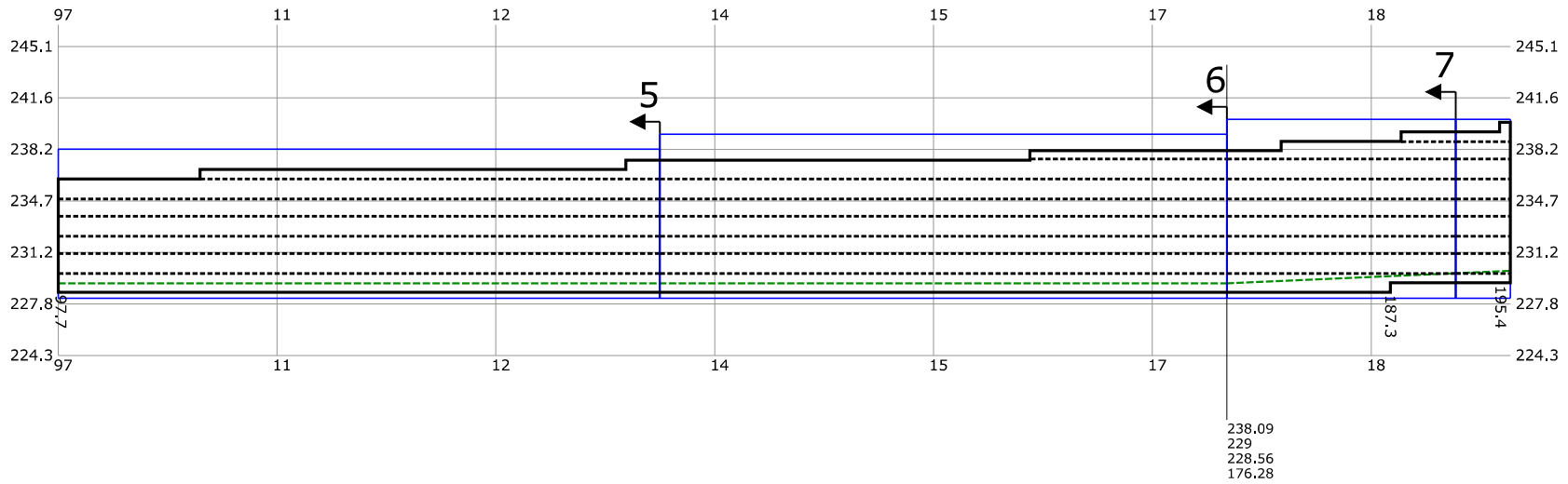
Engineer: James Brown

24GE03107100 Date:

Project Name: clinton commons  
 Location: 65 1/2 Center Street  
 Location: Hunderdon, NJ  
 Wall Number: 4  
 Project Number:  
 Designer: Bern Oles  
 Date: 4 18 22

Page #:  
**16**





### Elevation View

Section	5	6	7	8
Top	237.46	238.09	239.36	240
Grade	229	229	229.7	229.97
Bottom	228.56	228.56	229.2	229.2
Sta. Cut	138.09	176.28	191.7	197.58
Sta. End	138.09	176.28	191.7	197.58

I hereby certify that these calculations were prepared by me or under my direct supervision and that I am a duly licensed engineer certified and responsible for the content of these calculations.

Signature:

Engineer: James Brown

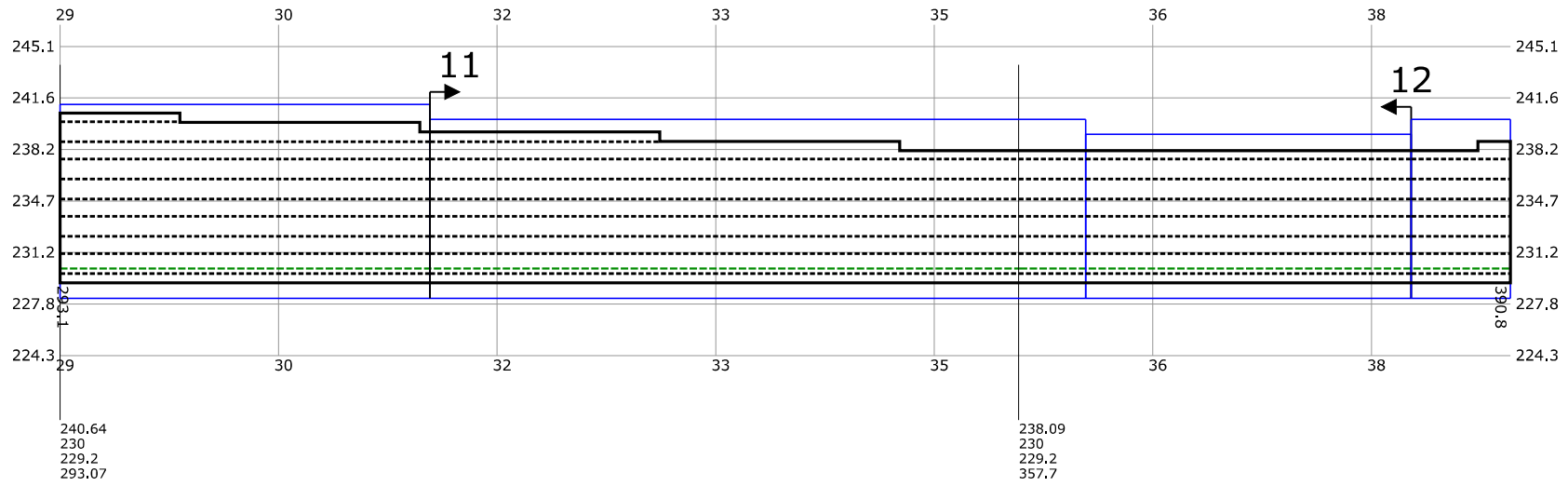
24GE03107100 Date:

Project Name: clinton commons  
 Location: 65 1/2 Center Street  
 Location: Hunderdon, NJ  
 Wall Number: 4  
 Project Number:  
 Designer: Bern Oles  
 Date: 4 18 22

Page #:

17





Top:  
Grade:  
Bottom:  
Station:

### Elevation View

Section	10	11	12	13
Top	240.64	239.36	238.09	238.73
Grade	230	230	230	230.26
Bottom	229.2	229.2	229.2	229.2
Sta. Cut	287.92	318.04	384.14	420.87
Sta. End	318.04	362.11	384.14	437.76

I hereby certify that these calculations were prepared by me or under my direct supervision and that I am a duly licensed engineer certified and responsible for the content of these calculations.

Signature:

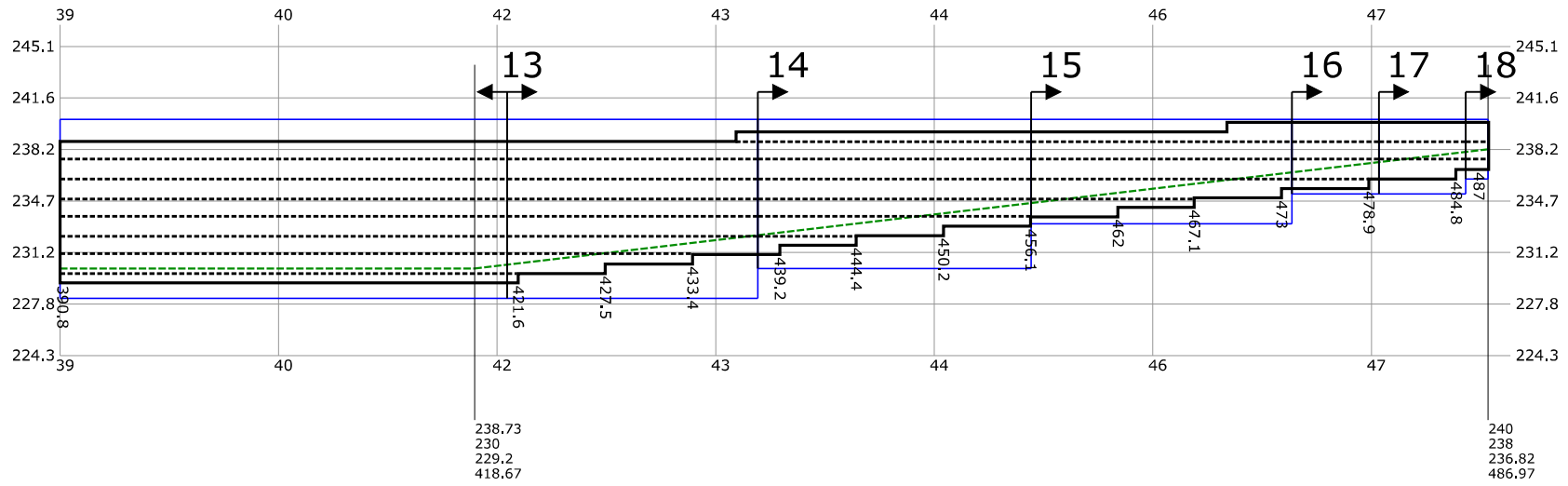
Engineer: James Brown

24GE03107100 Date:

Project Name: clinton commons  
 Location: 65 1/2 Center Street  
 Location: Hunderdon, NJ  
 Wall Number: 4  
 Project Number:  
 Designer: Bern Oles  
 Date: 4 18 22

Page #:

19



### Elevation View

Section	13	14	15	16	17	18
Top	238.73	239.36	239.36	240	240	240
Grade	230.26	232.24	234.39	236.45	237.14	237.83
Bottom	229.2	231.1	233.65	235.55	236.19	236.82
Sta. Cut	420.87	437.76	456.12	473.75	479.63	485.5
Sta. End	437.76	456.12	473.75	479.63	485.5	486.97

I hereby certify that these calculations were prepared by me or under my direct supervision and that I am a duly licensed engineer certified and responsible for the content of these calculations.

Signature:

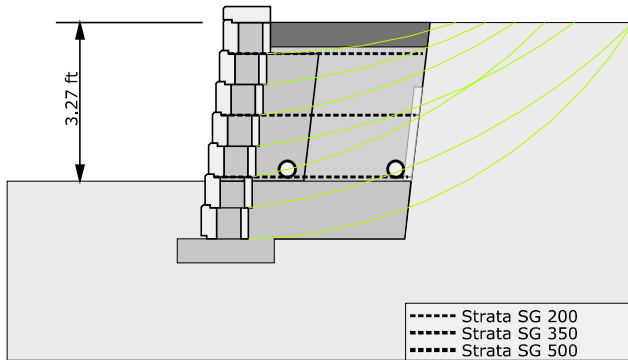
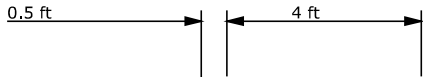
Engineer: James Brown

24GE03107100 Date:

Project Name: clinton commons  
 Location: 65 1/2 Center Street  
 Location: Hunderdon, NJ  
 Wall Number: 4  
 Project Number:  
 Designer: Bern Oles  
 Date: 4 18 22

Page #:  
**20**





AB Classic  
**Section 1 of 18**  
 Section 0 ft - 5.9 ft

**Base Information:**  
 Base Width: 2 ft  
 Base Depth: 0.5 ft  
 Base From Toe: 0.5 ft

**Geogrid Information:**  
 3 x Strata SG 200 @ 4 ft  
 Number Of Geogrid 3

**Wall Drain Options**  
 Infill Cap  
 Manufactured Drain Composite  
 Chimney Drain Height = 3.11 ft  
 Roll Width = 4 ft  
 On Center = 10 ft  
 Alternate Drain  
 Back of Infill Soil

**Section Notes**

- 1 - test this 1
- 2 - test this 3
- 3 - test this 3

<b>Wall Design Variables</b>
<b>AB Classic</b> Section Height 4.45 ft Total Panel Height 4.45 ft 0.635 ft Angle of Setback 6 Deg. Depth of Block 0.97 ft Length of Block 1.47 ft
<b>Safety Factors Static External</b> Actual Sliding 4.01 >= 1.5 Actual Overturning 11.46 >= 2
<b>Infill Soil</b> Friction Angle 30 Deg. Unit WT 120 pcf
<b>Retained Soil</b> Friction Angle 26 Deg. Unit WT 120 pcf
<b>Foundation Soil</b> Friction Angle 30 Deg. Unit WT 120 pcf Cohesion 0 psf
<b>Bearing Capacity</b> Factor of Safety 9.79 Sigma_ult - 5564.53 psf Sigma_max - 568.53 psf
<b>Internal Compound Stability</b> Factor of Safety 2.74 Course Number 0
<b>Wall Rock Requirements</b> Continuous Minimum Depth = 1 ft

- Strata SG 200
- Strata SG 350
- Strata SG 500

**Allan Block Disclaimer:**

Allan Block provides this software as a service for its clients. The sole purpose of this software is to assist engineers in the design of mechanically stabilized retaining walls. The software uses evaluation techniques and engineering principles found in the Allan Block Engineering Manual. (Refer to R0904 and supporting references.) It is the responsibility of the engineer of record to determine the propriety and accuracy of input parameters and to review and verify the correctness of the results. ALLAN BLOCK CORPORATION, ITS LICENSEES OR AGENTS DO NOT ASSUME ANY LIABILITY OR RESPONSIBILITY FOR DAMAGES WHICH MAY RESULT FROM THE USE OR MISUSE OF THIS SOFTWARE.

This software only considers internal, external and internal compound stability (ICS) of the reinforced composite mass. The internal compound stability calculations are limited to an evaluation zone above the base material and back no further than 2 \* H or He + L, whichever is greater. This program DOES NOT address global stability, defined as soil stability below the base material and beyond the limits for internal compound stability. Global Stability should be evaluated to determine if the overall site is stable. It is the responsibility of the owner to ensure the global stability is analyzed. The engineer of record must evaluate the project site for proper water management and all potential modes of failure within the segmental retaining wall evaluation zone. The geotechnical engineering firm contracted by the owner should provide a full global stability opinion of the site including the effects on the segmental retaining wall.

AB Walls contains DEFAULT values for all data inputs that the user MUST change or verify as appropriate for the project conditions being analyzed. These DEFAULT values do NOT ensure a conservative design for any site condition. The final design must provide for proper wall drainage to prevent the buildup of hydrostatic pressures over the service life of the structure. In the event additional water is introduced into the general wall area, either above or below grade, any designs from this software would be invalid unless otherwise noted by the engineer of record. It is also recommended that an independent assessment of the foundation soil for settlement potential and wall deflections for the proposed structure be performed. Changes in the subsoil conditions are not included in this software. These additional potential failure modes should be evaluated by the engineer of record prior to initiating wall construction and may require site inspection by the on-site soils engineer. All installations must conform to the Allan Block Spec Book. (Refer to R0901).

MathCAD files for hand calculations to support the software's consideration of internal, external and internal compound stability of the reinforced composite mass are provided in the AB Resources Drop Down Menu. These files are to be configured so that the engineer of record can evaluate the output of the software. Individual equations may be altered at the discretion of the engineer of record.

I hereby certify that these calculations were prepared by me or under my direct supervision and that I am a duly licensed engineer certified and responsible for the content of these calculations.

Signature:

Engineer: James Brown

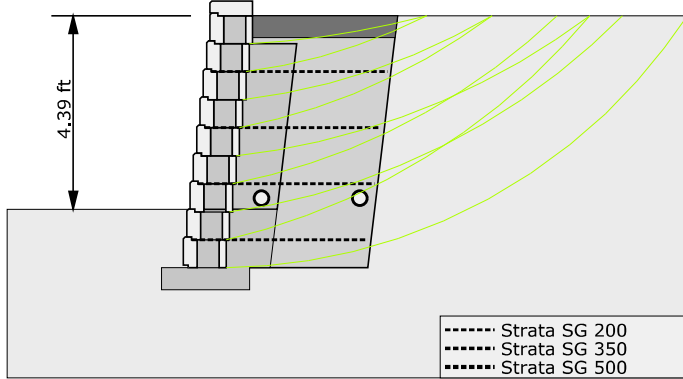
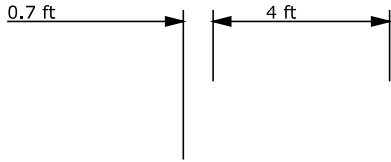
24GE03107100 Date:

Project Name: clinton commons  
 Location: 65 1/2 Center Street  
 Location: Hunderdon, NJ  
 Wall Number: 4  
 Project Number:  
 Designer: Bern Oles  
 Date: 4 18 22

Page #:  
**21**

**Section Notes**

- 1 - test this 1
- 2 - test this 3
- 3 - test this 3



**Wall Drain Options**  
 Infill Cap  
 Alternate Drain  
 Back of Wall Rock

AB Classic  
**Section 2 of 18**  
 Section 5.9 ft - 17.6 ft

**Base Information:**  
 Base Width: 2 ft  
 Base Depth: 0.5 ft  
 Base From Toe: 0.5 ft

**Geogrid Information:**  
 4 x Strata SG 200 @ 4 ft  
 Number Of Geogrid 4

**Allan Block Disclaimer:**

Allan Block provides this software as a service for its clients. The sole purpose of this software is to assist engineers in the design of mechanically stabilized retaining walls. The software uses evaluation techniques and engineering principles found in the Allan Block Engineering Manual. (Refer to R0904 and supporting references.) It is the responsibility of the engineer of record to determine the propriety and accuracy of input parameters and to review and verify the correctness of the results. ALLAN BLOCK CORPORATION, ITS LICENSEES OR AGENTS DO NOT ASSUME ANY LIABILITY OR RESPONSIBILITY FOR DAMAGES WHICH MAY RESULT FROM THE USE OR MISUSE OF THIS SOFTWARE.

This software only considers internal, external and internal compound stability (ICS) of the reinforced composite mass. The internal compound stability calculations are limited to an evaluation zone above the base material and back no further than 2 \* H or He + L, whichever is greater. This program DOES NOT address global stability, defined as soil stability below the base material and beyond the limits for internal compound stability. Global Stability should be evaluated to determine if the overall site is stable. It is the responsibility of the owner to ensure the global stability is analyzed. The engineer of record must evaluate the project site for proper water management and all potential modes of failure within the segmental retaining wall evaluation zone. The geotechnical engineering firm contracted by the owner should provide a full global stability opinion of the site including the effects on the segmental retaining wall.

AB Walls contains DEFAULT values for all data inputs that the user MUST change or verify as appropriate for the project conditions being analyzed. These DEFAULT values do NOT ensure a conservative design for any site condition. The final design must provide for proper wall drainage to prevent the buildup of hydrostatic pressures over the service life of the structure. In the event additional water is introduced into the general wall area, either above or below grade, any designs from this software would be invalid unless otherwise noted by the engineer of record. It is also recommended that an independent assessment of the foundation soil for settlement potential and wall deflections for the proposed structure be performed. Changes in the subsoil conditions are not included in this software. These additional potential failure modes should be evaluated by the engineer of record prior to initiating wall construction and may require site inspection by the on-site soils engineer. All installations must conform to the Allan Block Spec Book. (Refer to R0901).

MathCAD files for hand calculations to support the software's consideration of internal, external and internal compound stability of the reinforced composite mass are provided in the AB Resources Drop Down Menu. These files are to be configured so that the engineer of record can evaluate the output of the software. Individual equations may be altered at the discretion of the engineer of record.

**Wall Design Variables**

**AB Classic**

Section Height 5.72 ft  
 Total Panel Height 5.72 ft  
 0.635 ft  
 Angle of Setback 6 Deg.  
 Depth of Block 0.97 ft  
 Length of Block 1.47 ft

**Safety Factors Static External**

Actual Sliding  
 3.16 >= 1.5  
 Actual Overturning  
 7.3 >= 2

**Infill Soil**

Friction Angle 30 Deg.  
 Unit WT 120 pcf

**Retained Soil**

Friction Angle 26 Deg.  
 Unit WT 120 pcf

**Foundation Soil**

Friction Angle 30 Deg.  
 Unit WT 120 pcf  
 Cohesion 0 psf

**Bearing Capacity**

Factor of Safety 7.95  
 Sigma\_ult - 5887.23 psf  
 Sigma\_max - 740.34 psf

**Internal Compound Stability**

Factor of Safety 2.78  
 Course Number 0

**Wall Rock Requirements**

Continuous Minimum Depth = 1 ft

Project Name: clinton commons  
 Location: 65 1/2 Center Street  
 Location: Hunderdon, NJ  
 Wall Number: 4  
 Project Number:  
 Designer: Bern Oles  
 Date: 4 18 22

I hereby certify that these calculations were prepared by me or under my direct supervision and that I am a duly licensed engineer certified and responsible for the content of these calculations.

Signature:

Engineer: James Brown

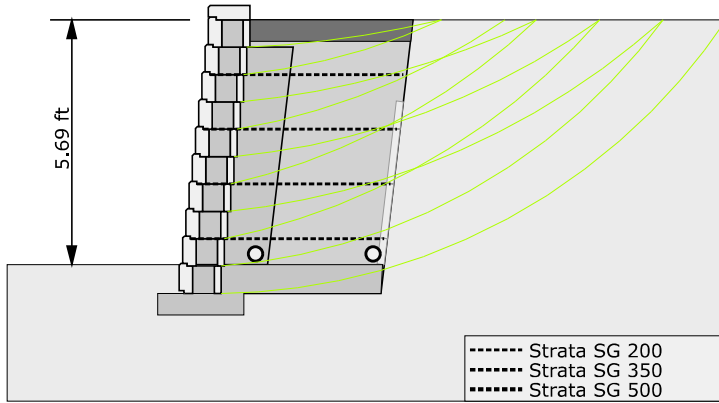
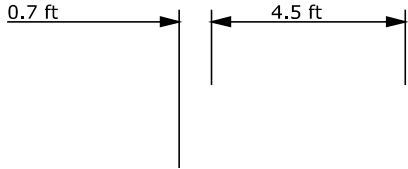
24GE03107100 Date:

Page #:

22

**Section Notes**

- 1 - test this 1
- 2 - test this 3
- 3 - test this 3



**Wall Drain Options**

- Infill Cap
- Manufactured Drain Composite
- Chimney Drain Height = 4.45 ft
- Roll Width = 4 ft
- On Center = 10 ft
- Alternate Drain
- Back of Infill Soil

AB Classic  
**Section 3 of 18**  
 Section 17.6 ft - 66.1 ft

**Base Information:**  
 Base Width: 2 ft  
 Base Depth: 0.5 ft  
 Base From Toe: 0.5 ft

**Geogrid Information:**  
 4 x Strata SG 200 @ 4.5 ft  
 Number Of Geogrid 4

<b>Wall Design Variables</b>
<b>AB Classic</b> Section Height 6.35 ft Total Panel Height 6.35 ft 0.635 ft Angle of Setback 6 Deg. Depth of Block 0.97 ft Length of Block 1.47 ft
<b>Safety Factors Static External</b> Actual Sliding 3.18 >= 1.5 Actual Overturning 7.39 >= 2
<b>Infill Soil</b> Friction Angle 30 Deg. Unit WT 120 pcf
<b>Retained Soil</b> Friction Angle 26 Deg. Unit WT 120 pcf
<b>Foundation Soil</b> Friction Angle 30 Deg. Unit WT 120 pcf Cohesion 0 psf
<b>Bearing Capacity</b> Factor of Safety 5.39 Sigma_ult - 4428.06 psf Sigma_max - 820.83 psf
<b>Internal Compound Stability</b> Factor of Safety 2.19 Course Number 0
<b>Wall Rock Requirements</b> Continuous Minimum Depth = 1 ft

**Allan Block Disclaimer:**

Allan Block provides this software as a service for its clients. The sole purpose of this software is to assist engineers in the design of mechanically stabilized retaining walls. The software uses evaluation techniques and engineering principles found in the Allan Block Engineering Manual. (Refer to R0904 and supporting references.) It is the responsibility of the engineer of record to determine the propriety and accuracy of input parameters and to review and verify the correctness of the results. ALLAN BLOCK CORPORATION, ITS LICENSEES OR AGENTS DO NOT ASSUME ANY LIABILITY OR RESPONSIBILITY FOR DAMAGES WHICH MAY RESULT FROM THE USE OR MISUSE OF THIS SOFTWARE.

This software only considers internal, external and internal compound stability (ICS) of the reinforced composite mass. The internal compound stability calculations are limited to an evaluation zone above the base material and back no further than 2 \* H or He + L, whichever is greater. This program DOES NOT address global stability, defined as soil stability below the base material and beyond the limits for internal compound stability. Global Stability should be evaluated to determine if the overall site is stable. It is the responsibility of the owner to ensure the global stability is analyzed. The engineer of record must evaluate the project site for proper water management and all potential modes of failure within the segmental retaining wall evaluation zone. The geotechnical engineering firm contracted by the owner should provide a full global stability opinion of the site including the effects on the segmental retaining wall.

AB Walls contains DEFAULT values for all data inputs that the user MUST change or verify as appropriate for the project conditions being analyzed. These DEFAULT values do NOT ensure a conservative design for any site condition. The final design must provide for proper wall drainage to prevent the buildup of hydrostatic pressures over the service life of the structure. In the event additional water is introduced into the general wall area, either above or below grade, any designs from this software would be invalid unless otherwise noted by the engineer of record. It is also recommended that an independent assessment of the foundation soil for settlement potential and wall deflections for the proposed structure be performed. Changes in the subsoil conditions are not included in this software. These additional potential failure modes should be evaluated by the engineer of record prior to initiating wall construction and may require site inspection by the on-site soils engineer. All installations must conform to the Allan Block Spec Book. (Refer to R0901).

MathCAD files for hand calculations to support the software's consideration of internal, external and internal compound stability of the reinforced composite mass are provided in the AB Resources Drop Down Menu. These files are to be configured so that the engineer of record can evaluate the output of the software. Individual equations may be altered at the discretion of the engineer of record.

I hereby certify that these calculations were prepared by me or under my direct supervision and that I am a duly licensed engineer certified and responsible for the content of these calculations.

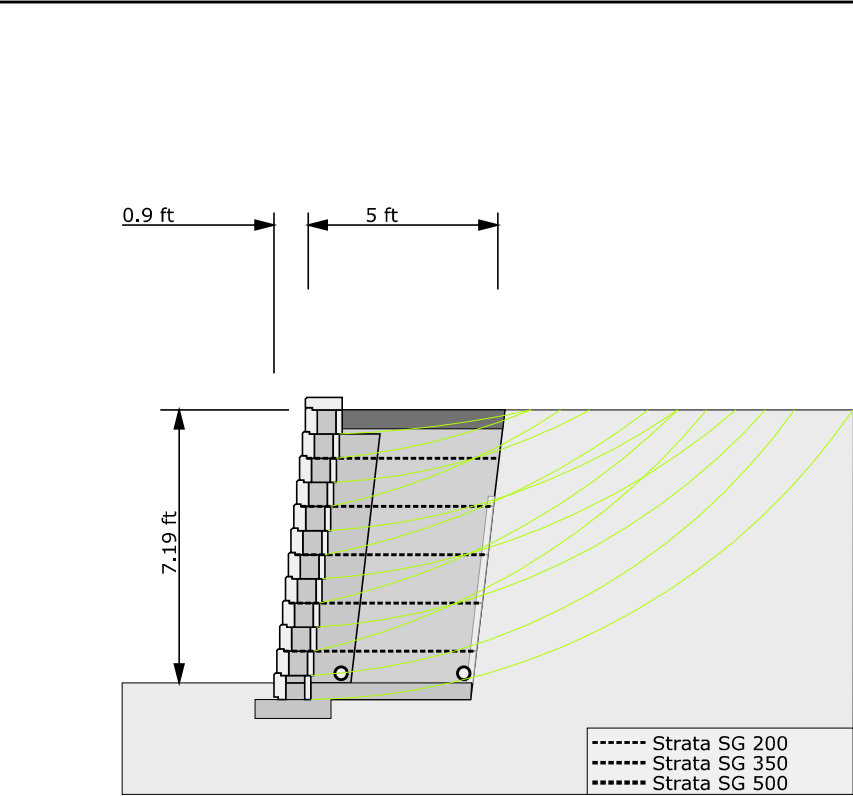
Signature:

Engineer: James Brown

24GE03107100 Date:

Project Name: clinton commons  
 Location: 65 1/2 Center Street  
 Location: Hunderdon, NJ  
 Wall Number: 4  
 Project Number:  
 Designer: Bern Oles  
 Date: 4 18 22

Page #:  
**23**



**Section Notes**

- 1 - test this 1
- 2 - test this 3
- 3 - test this 3

**Wall Drain Options**

- Infill Cap
- Manufactured Drain Composite
- Chimney Drain Height = 5.34 ft
- Roll Width = 4 ft
- On Center = 10 ft
- Alternate Drain
- Back of Infill Soil

AB Classic  
**Section 4 of 18**  
 Section 66.1 ft - 96.2 ft

**Base Information:**  
 Base Width: 2 ft  
 Base Depth: 0.5 ft  
 Base From Toe: 0.5 ft

**Geogrid Information:**  
 5 x Strata SG 200 @ 5 ft  
 Number Of Geogrid 5

**Allan Block Disclaimer:**

Allan Block provides this software as a service for its clients. The sole purpose of this software is to assist engineers in the design of mechanically stabilized retaining walls. The software uses evaluation techniques and engineering principles found in the Allan Block Engineering Manual. (Refer to R0904 and supporting references.) It is the responsibility of the engineer of record to determine the propriety and accuracy of input parameters and to review and verify the correctness of the results. ALLAN BLOCK CORPORATION, ITS LICENSEES OR AGENTS DO NOT ASSUME ANY LIABILITY OR RESPONSIBILITY FOR DAMAGES WHICH MAY RESULT FROM THE USE OR MISUSE OF THIS SOFTWARE.

This software only considers internal, external and internal compound stability (ICS) of the reinforced composite mass. The internal compound stability calculations are limited to an evaluation zone above the base material and back no further than 2 \* H or He + L, whichever is greater. This program DOES NOT address global stability, defined as soil stability below the base material and beyond the limits for internal compound stability. Global Stability should be evaluated to determine if the overall site is stable. It is the responsibility of the owner to ensure the global stability is analyzed. The engineer of record must evaluate the project site for proper water management and all potential modes of failure within the segmental retaining wall evaluation zone. The geotechnical engineering firm contracted by the owner should provide a full global stability opinion of the site including the effects on the segmental retaining wall.

AB Walls contains DEFAULT values for all data inputs that the user MUST change or verify as appropriate for the project conditions being analyzed. These DEFAULT values do NOT ensure a conservative design for any site condition. The final design must provide for proper wall drainage to prevent the buildup of hydrostatic pressures over the service life of the structure. In the event additional water is introduced into the general wall area, either above or below grade, any designs from this software would be invalid unless otherwise noted by the engineer of record. It is also recommended that an independent assessment of the foundation soil for settlement potential and wall deflections for the proposed structure be performed. Changes in the subsoil conditions are not included in this software. These additional potential failure modes should be evaluated by the engineer of record prior to initiating wall construction and may require site inspection by the on-site soils engineer. All installations must conform to the Allan Block Spec Book. (Refer to R0901).

MathCAD files for hand calculations to support the software's consideration of internal, external and internal compound stability of the reinforced composite mass are provided in the AB Resources Drop Down Menu. These files are to be configured so that the engineer of record can evaluate the output of the software. Individual equations may be altered at the discretion of the engineer of record.

<b>Wall Design Variables</b>
<b>AB Classic</b> Section Height 7.62 ft Total Panel Height 7.62 ft 0.635 ft Angle of Setback 6 Deg. Depth of Block 0.97 ft Length of Block 1.47 ft
<b>Safety Factors Static External</b> Actual Sliding 2.94 >= 1.5 Actual Overturning 6.4 >= 2
<b>Infill Soil</b> Friction Angle 30 Deg. Unit WT 120 pcf
<b>Retained Soil</b> Friction Angle 26 Deg. Unit WT 120 pcf
<b>Foundation Soil</b> Friction Angle 30 Deg. Unit WT 120 pcf Cohesion 0 psf
<b>Bearing Capacity</b> Factor of Safety 3.97 Sigma_ult - 3922.96 psf Sigma_max - 988.33 psf
<b>Internal Compound Stability</b> Factor of Safety 2.01 Course Number 0
<b>Wall Rock Requirements</b> Continuous Minimum Depth = 1 ft

I hereby certify that these calculations were prepared by me or under my direct supervision and that I am a duly licensed engineer certified and responsible for the content of these calculations.

Signature:

Engineer: James Brown

24GE03107100 Date:

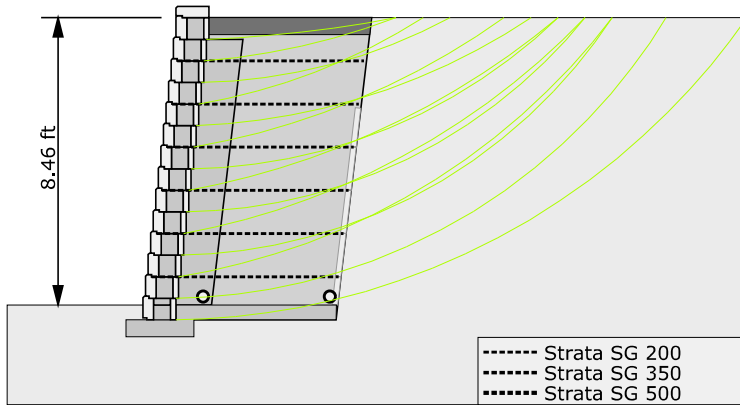
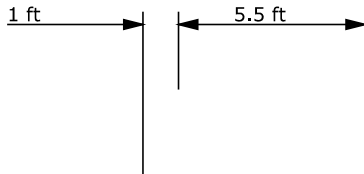
Project Name: clinton commons  
 Location: 65 1/2 Center Street  
 Location: Hunderdon, NJ  
 Wall Number: 4  
 Project Number:  
 Designer: Bern Oles  
 Date: 4 18 22

Page #:  
**24**



**Section Notes**

- 1 - test this 1
- 2 - test this 3
- 3 - test this 3



**Wall Drain Options**

- Infill Cap
- Manufactured Drain Composite
- Chimney Drain Height = 6.23 ft
- Roll Width = 4 ft
- On Center = 10 ft
- Alternate Drain
- Back of Infill Soil

AB Classic  
**Section 5 of 18**  
 Section 96.2 ft - 138.1 ft

**Base Information:**  
 Base Width: 2 ft  
 Base Depth: 0.5 ft  
 Base From Toe: 0.5 ft

**Geogrid Information:**  
 6 x Strata SG 200 @ 5.5 ft  
 Number Of Geogrid 6

<b>Wall Design Variables</b>
<b>AB Classic</b> Section Height 8.9 ft Total Panel Height 8.9 ft 0.635 ft Angle of Setback 6 Deg. Depth of Block 0.97 ft Length of Block 1.47 ft
<b>Safety Factors Static External</b> Actual Sliding 2.77 >= 1.5 Actual Overturning 5.73 >= 2
<b>Infill Soil</b> Friction Angle 30 Deg. Unit WT 120 pcf
<b>Retained Soil</b> Friction Angle 26 Deg. Unit WT 120 pcf
<b>Foundation Soil</b> Friction Angle 30 Deg. Unit WT 120 pcf Cohesion 0 psf
<b>Bearing Capacity</b> Factor of Safety 3.39 Sigma_ult - 3922.96 psf Sigma_max - 1156.25 psf
<b>Internal Compound Stability</b> Factor of Safety 1.91 Course Number 0
<b>Wall Rock Requirements</b> Continuous Minimum Depth = 1 ft

**Allan Block Disclaimer:**

Allan Block provides this software as a service for its clients. The sole purpose of this software is to assist engineers in the design of mechanically stabilized retaining walls. The software uses evaluation techniques and engineering principles found in the Allan Block Engineering Manual. (Refer to R0904 and supporting references.) It is the responsibility of the engineer of record to determine the propriety and accuracy of input parameters and to review and verify the correctness of the results. ALLAN BLOCK CORPORATION, ITS LICENSEES OR AGENTS DO NOT ASSUME ANY LIABILITY OR RESPONSIBILITY FOR DAMAGES WHICH MAY RESULT FROM THE USE OR MISUSE OF THIS SOFTWARE.

This software only considers internal, external and internal compound stability (ICS) of the reinforced composite mass. The internal compound stability calculations are limited to an evaluation zone above the base material and back no further than 2 \* H or He + L, whichever is greater. This program DOES NOT address global stability, defined as soil stability below the base material and beyond the limits for internal compound stability. Global Stability should be evaluated to determine if the overall site is stable. It is the responsibility of the owner to ensure the global stability is analyzed. The engineer of record must evaluate the project site for proper water management and all potential modes of failure within the segmental retaining wall evaluation zone. The geotechnical engineering firm contracted by the owner should provide a full global stability opinion of the site including the effects on the segmental retaining wall.

AB Walls contains DEFAULT values for all data inputs that the user MUST change or verify as appropriate for the project conditions being analyzed. These DEFAULT values do NOT ensure a conservative design for any site condition. The final design must provide for proper wall drainage to prevent the buildup of hydrostatic pressures over the service life of the structure. In the event additional water is introduced into the general wall area, either above or below grade, any designs from this software would be invalid unless otherwise noted by the engineer of record. It is also recommended that an independent assessment of the foundation soil for settlement potential and wall deflections for the proposed structure be performed. Changes in the subsoil conditions are not included in this software. These additional potential failure modes should be evaluated by the engineer of record prior to initiating wall construction and may require site inspection by the on-site soils engineer. All installations must conform to the Allan Block Spec Book. (Refer to R0901).

MathCAD files for hand calculations to support the software's consideration of internal, external and internal compound stability of the reinforced composite mass are provided in the AB Resources Drop Down Menu. These files are to be configured so that the engineer of record can evaluate the output of the software. Individual equations may be altered at the discretion of the engineer of record.

I hereby certify that these calculations were prepared by me or under my direct supervision and that I am a duly licensed engineer certified and responsible for the content of these calculations.

Signature:

Engineer: James Brown

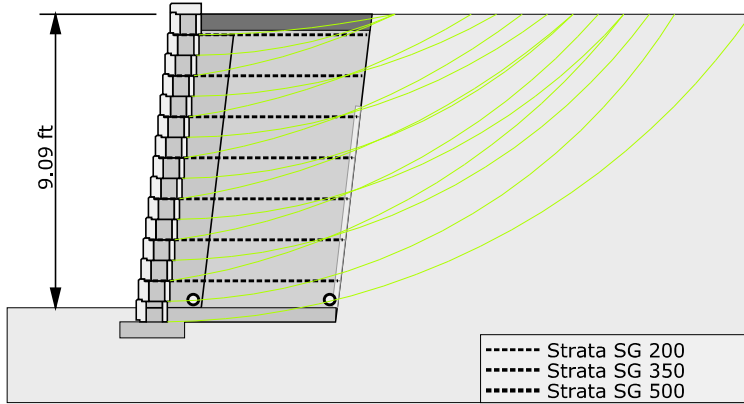
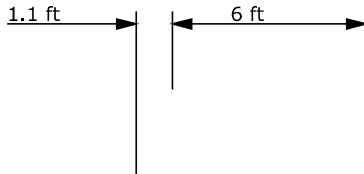
24GE03107100 Date:

Project Name: clinton commons  
 Location: 65 1/2 Center Street  
 Location: Hunderdon, NJ  
 Wall Number: 4  
 Project Number:  
 Designer: Bern Oles  
 Date: 4 18 22

Page #:  
**25**

**Section Notes**

- 1 - test this 1
- 2 - test this 3
- 3 - test this 3



----- Strata SG 200  
 ----- Strata SG 350  
 ----- Strata SG 500

**Wall Drain Options**

- Infill Cap
- Manufactured Drain Composite
- Chimney Drain Height = 6.67 ft
- Roll Width = 4 ft
- On Center = 10 ft
- Alternate Drain
- Back of Infill Soil

AB Classic  
**Section 6 of 18**  
 Section 138.1 ft - 176.3 ft

**Base Information:**  
 Base Width: 2 ft  
 Base Depth: 0.5 ft  
 Base From Toe: 0.5 ft

**Geogrid Information:**  
 7 x Strata SG 200 @ 6 ft  
 Number Of Geogrid 7

<b>Wall Design Variables</b>
<b>AB Classic</b> Section Height 9.53 ft Total Panel Height 9.53 ft 0.635 ft Angle of Setback 6 Deg. Depth of Block 0.97 ft Length of Block 1.47 ft
<b>Safety Factors Static External</b> Actual Sliding 2.81 >= 1.5 Actual Overturning 5.88 >= 2
<b>Infill Soil</b> Friction Angle 30 Deg. Unit WT 120 pcf
<b>Retained Soil</b> Friction Angle 26 Deg. Unit WT 120 pcf
<b>Foundation Soil</b> Friction Angle 30 Deg. Unit WT 120 pcf Cohesion 0 psf
<b>Bearing Capacity</b> Factor of Safety 3.17 Sigma_ult - 3922.96 psf Sigma_max - 1236.43 psf
<b>Internal Compound Stability</b> Factor of Safety 1.87 Course Number 0
<b>Wall Rock Requirements</b> Continuous Minimum Depth = 1 ft

**Allan Block Disclaimer:**

Allan Block provides this software as a service for its clients. The sole purpose of this software is to assist engineers in the design of mechanically stabilized retaining walls. The software uses evaluation techniques and engineering principles found in the Allan Block Engineering Manual. (Refer to R0904 and supporting references.) It is the responsibility of the engineer of record to determine the propriety and accuracy of input parameters and to review and verify the correctness of the results. ALLAN BLOCK CORPORATION, ITS LICENSEES OR AGENTS DO NOT ASSUME ANY LIABILITY OR RESPONSIBILITY FOR DAMAGES WHICH MAY RESULT FROM THE USE OR MISUSE OF THIS SOFTWARE.

This software only considers internal, external and internal compound stability (ICS) of the reinforced composite mass. The internal compound stability calculations are limited to an evaluation zone above the base material and back no further than 2 \* H or He + L, whichever is greater. This program DOES NOT address global stability, defined as soil stability below the base material and beyond the limits for internal compound stability. Global Stability should be evaluated to determine if the overall site is stable. It is the responsibility of the owner to ensure the global stability is analyzed. The engineer of record must evaluate the project site for proper water management and all potential modes of failure within the segmental retaining wall evaluation zone. The geotechnical engineering firm contracted by the owner should provide a full global stability opinion of the site including the effects on the segmental retaining wall.

AB Walls contains DEFAULT values for all data inputs that the user MUST change or verify as appropriate for the project conditions being analyzed. These DEFAULT values do NOT ensure a conservative design for any site condition. The final design must provide for proper wall drainage to prevent the buildup of hydrostatic pressures over the service life of the structure. In the event additional water is introduced into the general wall area, either above or below grade, any designs from this software would be invalid unless otherwise noted by the engineer of record. It is also recommended that an independent assessment of the foundation soil for settlement potential and wall deflections for the proposed structure be performed. Changes in the subsoil conditions are not included in this software. These additional potential failure modes should be evaluated by the engineer of record prior to initiating wall construction and may require site inspection by the on-site soils engineer. All installations must conform to the Allan Block Spec Book. (Refer to R0901).

MathCAD files for hand calculations to support the software's consideration of internal, external and internal compound stability of the reinforced composite mass are provided in the AB Resources Drop Down Menu. These files are to be configured so that the engineer of record can evaluate the output of the software. Individual equations may be altered at the discretion of the engineer of record.

I hereby certify that these calculations were prepared by me or under my direct supervision and that I am a duly licensed engineer certified and responsible for the content of these calculations.

Signature:

Engineer: James Brown

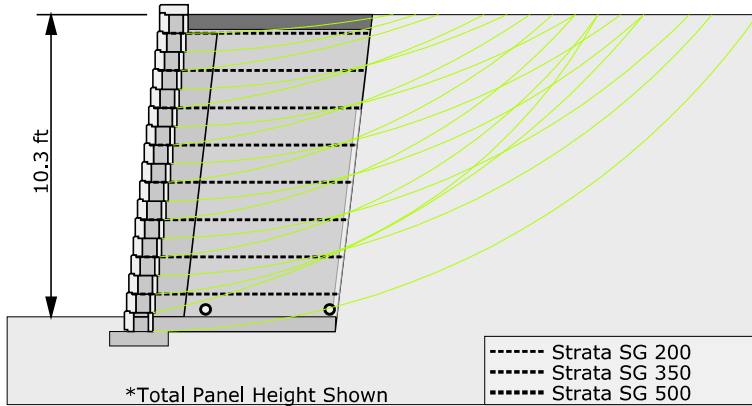
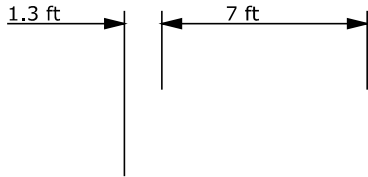
24GE03107100 Date:

Project Name: clinton commons  
 Location: 65 1/2 Center Street  
 Location: Hunderdon, NJ  
 Wall Number: 4  
 Project Number:  
 Designer: Bern Oles  
 Date: 4 18 22

Page #:  
**26**

**Section Notes**

- 1 - test this 1
- 2 - test this 3
- 3 - test this 3



**Wall Drain Options**

- Infill Cap
- Manufactured Drain Composite
- Chimney Drain Height = 7.56 ft
- Roll Width = 4 ft
- On Center = 10 ft
- Alternate Drain
- Back of Infill Soil

AB Classic  
**Section 7 of 18**  
 Section 176.3 ft - 191.7 ft

**Base Information:**  
 Base Width: 2 ft  
 Base Depth: 0.5 ft  
 Base From Toe: 0.5 ft

**Geogrid Information:**  
 8 x Strata SG 200 @ 7 ft  
 Number Of Geogrid 8

**Allan Block Disclaimer:**

Allan Block provides this software as a service for its clients. The sole purpose of this software is to assist engineers in the design of mechanically stabilized retaining walls. The software uses evaluation techniques and engineering principles found in the Allan Block Engineering Manual. (Refer to R0904 and supporting references.) It is the responsibility of the engineer of record to determine the propriety and accuracy of input parameters and to review and verify the correctness of the results. ALLAN BLOCK CORPORATION, ITS LICENSEES OR AGENTS DO NOT ASSUME ANY LIABILITY OR RESPONSIBILITY FOR DAMAGES WHICH MAY RESULT FROM THE USE OR MISUSE OF THIS SOFTWARE.

This software only considers internal, external and internal compound stability (ICS) of the reinforced composite mass. The internal compound stability calculations are limited to an evaluation zone above the base material and back no further than 2 \* H or He + L, whichever is greater. This program DOES NOT address global stability, defined as soil stability below the base material and beyond the limits for internal compound stability. Global Stability should be evaluated to determine if the overall site is stable. It is the responsibility of the owner to ensure the global stability is analyzed. The engineer of record must evaluate the project site for proper water management and all potential modes of failure within the segmental retaining wall evaluation zone. The geotechnical engineering firm contracted by the owner should provide a full global stability opinion of the site including the effects on the segmental retaining wall.

AB Walls contains DEFAULT values for all data inputs that the user MUST change or verify as appropriate for the project conditions being analyzed. These DEFAULT values do NOT ensure a conservative design for any site condition. The final design must provide for proper wall drainage to prevent the buildup of hydrostatic pressures over the service life of the structure. In the event additional water is introduced into the general wall area, either above or below grade, any designs from this software would be invalid unless otherwise noted by the engineer of record. It is also recommended that an independent assessment of the foundation soil for settlement potential and wall deflections for the proposed structure be performed. Changes in the subsoil conditions are not included in this software. These additional potential failure modes should be evaluated by the engineer of record prior to initiating wall construction and may require site inspection by the on-site soils engineer. All installations must conform to the Allan Block Spec Book. (Refer to R0901).

MathCAD files for hand calculations to support the software's consideration of internal, external and internal compound stability of the reinforced composite mass are provided in the AB Resources Drop Down Menu. These files are to be configured so that the engineer of record can evaluate the output of the software. Individual equations may be altered at the discretion of the engineer of record.

**Wall Design Variables**

**AB Classic**

Section Height 10.17 ft  
 Total Panel Height 10.8 ft  
 0.635 ft  
 Angle of Setback 6 Deg.  
 Depth of Block 0.97 ft  
 Length of Block 1.47 ft

**Safety Factors Static External**

Actual Sliding  
 2.87 >= 1.5  
 Actual Overturning  
 6.14 >= 2

**Infill Soil**

Friction Angle 30 Deg.  
 Unit WT 120 pcf

**Retained Soil**

Friction Angle 26 Deg.  
 Unit WT 120 pcf

**Foundation Soil**

Friction Angle 30 Deg.  
 Unit WT 120 pcf  
 Cohesion 0 psf

**Bearing Capacity**

Factor of Safety 2.91  
 Sigma\_ult - 4063.26 psf  
 Sigma\_max - 1396.97 psf

**Internal Compound Stability**

Factor of Safety 1.83  
 Course Number 0

**Wall Rock Requirements**

Continuous Minimum Depth = 1 ft

Project Name: clinton commons  
 Location: 65 1/2 Center Street  
 Location: Hunderdon, NJ  
 Wall Number: 4  
 Project Number:  
 Designer: Bern Oles  
 Date: 4 18 22

I hereby certify that these calculations were prepared by me or under my direct supervision and that I am a duly licensed engineer certified and responsible for the content of these calculations.

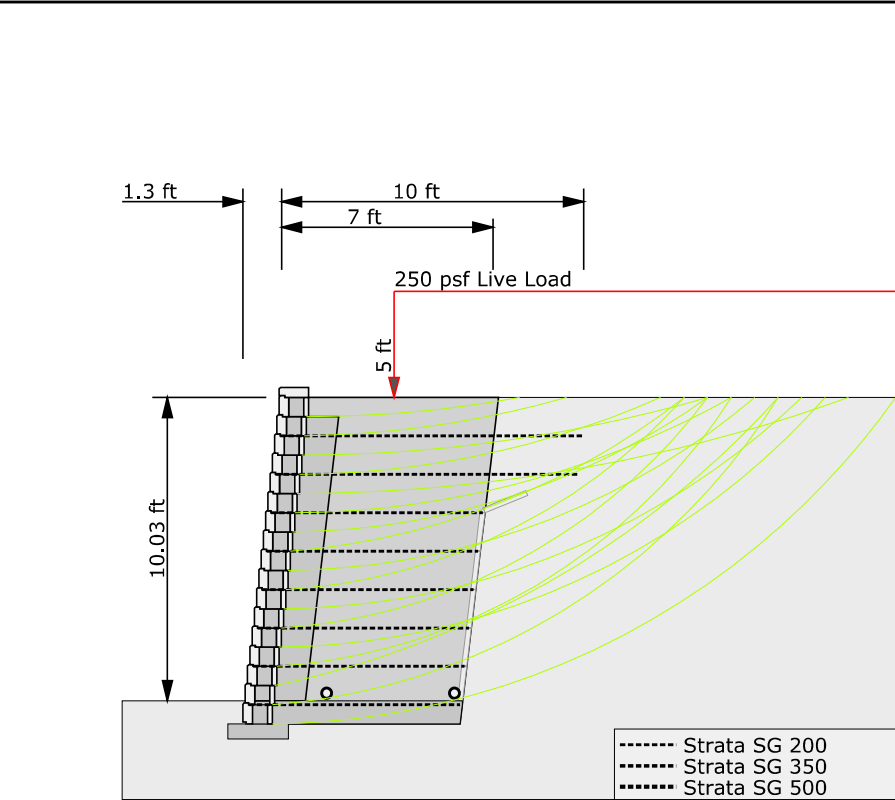
Signature:

Engineer: James Brown

24GE03107100 Date:

Page #:

27



**Section Notes**

- 1 - test this 1
- 2 - test this 3
- 3 - test this 3

**Wall Drain Options**  
 Manufactured Drain Composite  
 Chimney Drain Height = 7.56 ft  
 Roll Width = 4 ft  
 On Center = 10 ft  
 Alternate Drain  
 Back of Infill Soil

AB Classic  
**Section 8 of 18**  
 Section 191.7 ft - 197.6 ft

**Base Information:**  
 Base Width: 2 ft  
 Base Depth: 0.5 ft  
 Base From Toe: 0.5 ft

**Geogrid Information:**  
 2 x Strata SG 200 @ 10 ft  
 6 x Strata SG 200 @ 7 ft  
 Number Of Geogrid 8

<b>Wall Design Variables</b>
<b>AB Classic</b> Section Height 10.8 ft Total Panel Height 10.8 ft 0.635 ft Angle of Setback 6 Deg. Depth of Block 0.97 ft Length of Block 1.47 ft
<b>Surcharge Parameters</b> 250 psf Live Load: 5 ft - 30 ft (Distance measured from toe of wall)
<b>Safety Factors Static External</b> Actual Sliding 2.07 >= 1.5 Actual Overturning 3.89 >= 2
<b>Infill Soil</b> Friction Angle 30 Deg. Unit WT 120 pcf
<b>Retained Soil</b> Friction Angle 26 Deg. Unit WT 120 pcf
<b>Foundation Soil</b> Friction Angle 30 Deg. Unit WT 120 pcf Cohesion 0 psf
<b>Bearing Capacity</b> Factor of Safety 3.01 Sigma_ult - 4652.54 psf Sigma_max - 1544.17 psf
<b>Internal Compound Stability</b> Factor of Safety 1.76 Course Number 1
<b>Wall Rock Requirements</b> Continuous Minimum Depth = 1 ft

**Allan Block Disclaimer:**

Allan Block provides this software as a service for its clients. The sole purpose of this software is to assist engineers in the design of mechanically stabilized retaining walls. The software uses evaluation techniques and engineering principles found in the Allan Block Engineering Manual. (Refer to R0904 and supporting references.) It is the responsibility of the engineer of record to determine the propriety and accuracy of input parameters and to review and verify the correctness of the results. ALLAN BLOCK CORPORATION, ITS LICENSEES OR AGENTS DO NOT ASSUME ANY LIABILITY OR RESPONSIBILITY FOR DAMAGES WHICH MAY RESULT FROM THE USE OR MISUSE OF THIS SOFTWARE.

This software only considers internal, external and internal compound stability (ICS) of the reinforced composite mass. The internal compound stability calculations are limited to an evaluation zone above the base material and back no further than 2 \* H or He + L, whichever is greater. This program DOES NOT address global stability, defined as soil stability below the base material and beyond the limits for internal compound stability. Global Stability should be evaluated to determine if the overall site is stable. It is the responsibility of the owner to ensure the global stability is analyzed. The engineer of record must evaluate the project site for proper water management and all potential modes of failure within the segmental retaining wall evaluation zone. The geotechnical engineering firm contracted by the owner should provide a full global stability opinion of the site including the effects on the segmental retaining wall.

AB Walls contains DEFAULT values for all data inputs that the user MUST change or verify as appropriate for the project conditions being analyzed. These DEFAULT values do NOT ensure a conservative design for any site condition. The final design must provide for proper wall drainage to prevent the buildup of hydrostatic pressures over the service life of the structure. In the event additional water is introduced into the general wall area, either above or below grade, any designs from this software would be invalid unless otherwise noted by the engineer of record. It is also recommended that an independent assessment of the foundation soil for settlement potential and wall deflections for the proposed structure be performed. Changes in the subsoil conditions are not included in this software. These additional potential failure modes should be evaluated by the engineer of record prior to initiating wall construction and may require site inspection by the on-site soils engineer. All installations must conform to the Allan Block Spec Book. (Refer to R0901).

MathCAD files for hand calculations to support the software's consideration of internal, external and internal compound stability of the reinforced composite mass are provided in the AB Resources Drop Down Menu. These files are to be configured so that the engineer of record can evaluate the output of the software. Individual equations may be altered at the discretion of the engineer of record.

I hereby certify that these calculations were prepared by me or under my direct supervision and that I am a duly licensed engineer certified and responsible for the content of these calculations.

Signature:

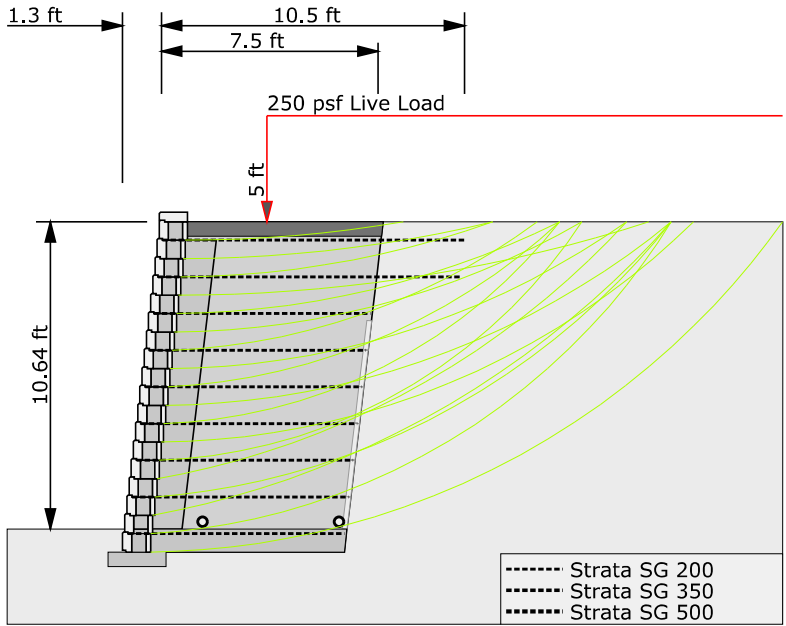
Engineer: James Brown

24GE03107100 Date:

Project Name: clinton commons  
 Location: 65 1/2 Center Street  
 Location: Hunderdon, NJ  
 Wall Number: 4  
 Project Number:  
 Designer: Bern Oles  
 Date: 4 18 22

Page #:  
**28**





**Wall Drain Options**  
 Infill Cap  
 Manufactured Drain Composite  
 Chimney Drain Height = 8.01 ft  
 Roll Width = 4 ft  
 On Center = 10 ft  
 Alternate Drain  
 Back of Infill Soil

AB Classic  
**Section 9 of 18**  
 Section 197.6 ft - 287.9 ft

**Base Information:**  
 Base Width: 2 ft  
 Base Depth: 0.5 ft  
 Base From Toe: 0.5 ft

**Geogrid Information:**  
 2 x Strata SG 200 @ 10.5 ft  
 7 x Strata SG 200 @ 7.5 ft  
 Number Of Geogrid 9

**Allan Block Disclaimer:**

Allan Block provides this software as a service for its clients. The sole purpose of this software is to assist engineers in the design of mechanically stabilized retaining walls. The software uses evaluation techniques and engineering principles found in the Allan Block Engineering Manual. (Refer to R0904 and supporting references.) It is the responsibility of the engineer of record to determine the propriety and accuracy of input parameters and to review and verify the correctness of the results. ALLAN BLOCK CORPORATION, ITS LICENSEES OR AGENTS DO NOT ASSUME ANY LIABILITY OR RESPONSIBILITY FOR DAMAGES WHICH MAY RESULT FROM THE USE OR MISUSE OF THIS SOFTWARE.

This software only considers internal, external and internal compound stability (ICS) of the reinforced composite mass. The internal compound stability calculations are limited to an evaluation zone above the base material and back no further than 2 \* H or He + L, whichever is greater. This program DOES NOT address global stability, defined as soil stability below the base material and beyond the limits for internal compound stability. Global Stability should be evaluated to determine if the overall site is stable. It is the responsibility of the owner to ensure the global stability is analyzed. The engineer of record must evaluate the project site for proper water management and all potential modes of failure within the segmental retaining wall evaluation zone. The geotechnical engineering firm contracted by the owner should provide a full global stability opinion of the site including the effects on the segmental retaining wall.

AB Walls contains DEFAULT values for all data inputs that the user MUST change or verify as appropriate for the project conditions being analyzed. These DEFAULT values do NOT ensure a conservative design for any site condition. The final design must provide for proper wall drainage to prevent the buildup of hydrostatic pressures over the service life of the structure. In the event additional water is introduced into the general wall area, either above or below grade, any designs from this software would be invalid unless otherwise noted by the engineer of record. It is also recommended that an independent assessment of the foundation soil for settlement potential and wall deflections for the proposed structure be performed. Changes in the subsoil conditions are not included in this software. These additional potential failure modes should be evaluated by the engineer of record prior to initiating wall construction and may require site inspection by the on-site soils engineer. All installations must conform to the Allan Block Spec Book. (Refer to R0901).

MathCAD files for hand calculations to support the software's consideration of internal, external and internal compound stability of the reinforced composite mass are provided in the AB Resources Drop Down Menu. These files are to be configured so that the engineer of record can evaluate the output of the software. Individual equations may be altered at the discretion of the engineer of record.

<b>Wall Design Variables</b>
<b>AB Classic</b> Section Height 11.44 ft Total Panel Height 11.44 ft 0.635 ft Angle of Setback 6 Deg. Depth of Block 0.97 ft Length of Block 1.47 ft
<b>Surcharge Parameters</b> 250 psf Live Load: 5 ft - 30 ft (Distance measured from toe of wall)
<b>Safety Factors Static External</b> Actual Sliding 2.12 >= 1.5 Actual Overturning 4.04 >= 2
<b>Infill Soil</b> Friction Angle 30 Deg. Unit WT 120 pcf
<b>Retained Soil</b> Friction Angle 26 Deg. Unit WT 120 pcf
<b>Foundation Soil</b> Friction Angle 30 Deg. Unit WT 120 pcf Cohesion 0 psf
<b>Bearing Capacity</b> Factor of Safety 2.94 Sigma_ult - 4722.7 psf Sigma_max - 1608.53 psf
<b>Internal Compound Stability</b> Factor of Safety 1.75 Course Number 1
<b>Wall Rock Requirements</b> Continuous Minimum Depth = 1 ft

Project Name: clinton commons  
 Location: 65 1/2 Center Street  
 Location: Hunderdon, NJ  
 Wall Number: 4  
 Project Number:  
 Designer: Bern Oles  
 Date: 4 18 22

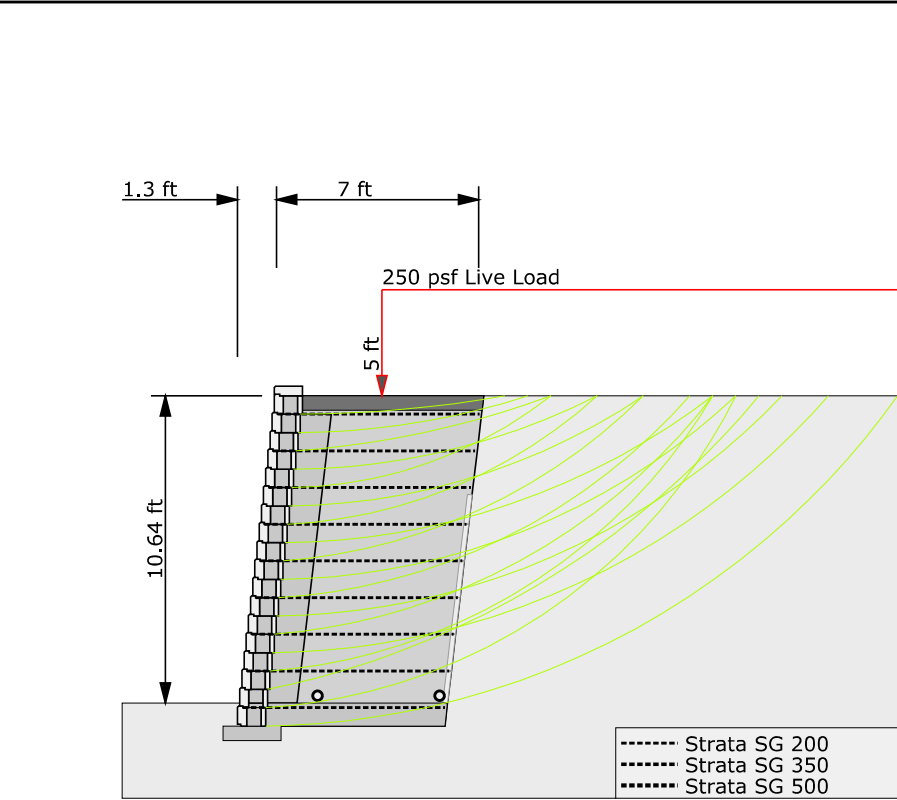
I hereby certify that these calculations were prepared by me or under my direct supervision and that I am a duly licensed engineer certified and responsible for the content of these calculations.

Signature:

Engineer: James Brown

24GE03107100 Date:

Page #:  
**29**



AB Classic  
**Section 10 of 18**  
 Section 287.9 ft - 318 ft

**Base Information:**  
 Base Width: 2 ft  
 Base Depth: 0.5 ft  
 Base From Toe: 0.5 ft

**Geogrid Information:**  
 9 x Strata SG 200 @ 7 ft  
 Number Of Geogrid 9

**Section Notes**

- 1 - test this 1
- 2 - test this 3
- 3 - test this 3

**Wall Drain Options**

- Infill Cap
- Manufactured Drain Composite
- Chimney Drain Height = 8.01 ft
- Roll Width = 4 ft
- On Center = 10 ft
- Alternate Drain
- Back of Infill Soil

<b>Wall Design Variables</b>
<b>AB Classic</b> Section Height 11.44 ft Total Panel Height 11.44 ft 0.635 ft Angle of Setback 6 Deg. Depth of Block 0.97 ft Length of Block 1.47 ft
<b>Surcharge Parameters</b> 250 psf Live Load: 5 ft - 30 ft (Distance measured from toe of wall)
<b>Safety Factors Static External</b> Actual Sliding 2 >= 1.5 Actual Overturning 3.59 >= 2
<b>Infill Soil</b> Friction Angle 30 Deg. Unit WT 120 pcf
<b>Retained Soil</b> Friction Angle 26 Deg. Unit WT 120 pcf
<b>Foundation Soil</b> Friction Angle 30 Deg. Unit WT 120 pcf Cohesion 0 psf
<b>Bearing Capacity</b> Factor of Safety 2.75 Sigma_ult - 4722.7 psf Sigma_max - 1718.82 psf
<b>Internal Compound Stability</b> Factor of Safety 1.7 Course Number 1
<b>Wall Rock Requirements</b> Continuous Minimum Depth = 1 ft

**Allan Block Disclaimer:**

Allan Block provides this software as a service for its clients. The sole purpose of this software is to assist engineers in the design of mechanically stabilized retaining walls. The software uses evaluation techniques and engineering principles found in the Allan Block Engineering Manual. (Refer to R0904 and supporting references.) It is the responsibility of the engineer of record to determine the propriety and accuracy of input parameters and to review and verify the correctness of the results. ALLAN BLOCK CORPORATION, ITS LICENSEES OR AGENTS DO NOT ASSUME ANY LIABILITY OR RESPONSIBILITY FOR DAMAGES WHICH MAY RESULT FROM THE USE OR MISUSE OF THIS SOFTWARE.

This software only considers internal, external and internal compound stability (ICS) of the reinforced composite mass. The internal compound stability calculations are limited to an evaluation zone above the base material and back no further than 2 \* H or He + L, whichever is greater. This program DOES NOT address global stability, defined as soil stability below the base material and beyond the limits for internal compound stability. Global Stability should be evaluated to determine if the overall site is stable. It is the responsibility of the owner to ensure the global stability is analyzed. The engineer of record must evaluate the project site for proper water management and all potential modes of failure within the segmental retaining wall evaluation zone. The geotechnical engineering firm contracted by the owner should provide a full global stability opinion of the site including the effects on the segmental retaining wall.

AB Walls contains DEFAULT values for all data inputs that the user MUST change or verify as appropriate for the project conditions being analyzed. These DEFAULT values do NOT ensure a conservative design for any site condition. The final design must provide for proper wall drainage to prevent the buildup of hydrostatic pressures over the service life of the structure. In the event additional water is introduced into the general wall area, either above or below grade, any designs from this software would be invalid unless otherwise noted by the engineer of record. It is also recommended that an independent assessment of the foundation soil for settlement potential and wall deflections for the proposed structure be performed. Changes in the subsoil conditions are not included in this software. These additional potential failure modes should be evaluated by the engineer of record prior to initiating wall construction and may require site inspection by the on-site soils engineer. All installations must conform to the Allan Block Spec Book. (Refer to R0901).

MathCAD files for hand calculations to support the software's consideration of internal, external and internal compound stability of the reinforced composite mass are provided in the AB Resources Drop Down Menu. These files are to be configured so that the engineer of record can evaluate the output of the software. Individual equations may be altered at the discretion of the engineer of record.

I hereby certify that these calculations were prepared by me or under my direct supervision and that I am a duly licensed engineer certified and responsible for the content of these calculations.

Signature:

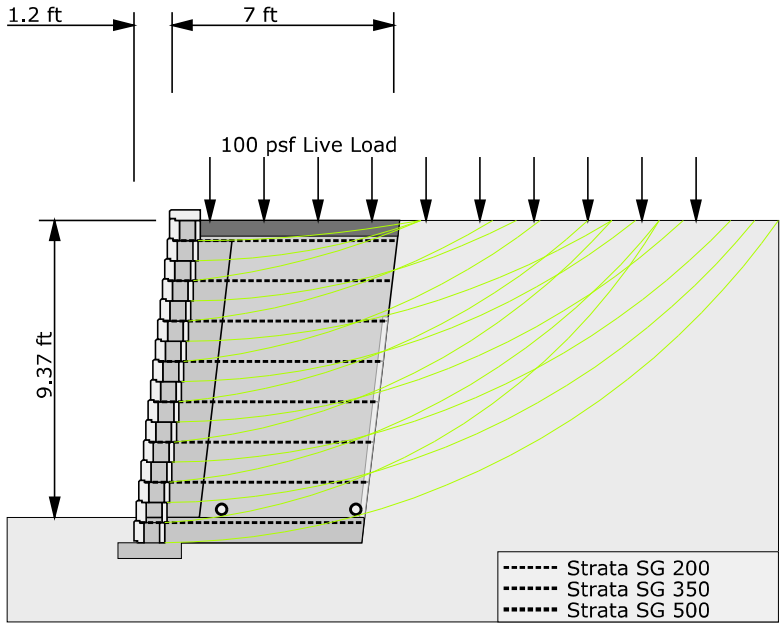
Engineer: James Brown

24GE03107100 Date:

Project Name: clinton commons  
 Location: 65 1/2 Center Street  
 Location: Hunderdon, NJ  
 Wall Number: 4  
 Project Number:  
 Designer: Bern Oles  
 Date: 4 18 22

Page #:

30



**Section Notes**

- 1 - test this 1
- 2 - test this 3
- 3 - test this 3

**Wall Drain Options**  
 Infill Cap  
 Manufactured Drain Composite  
 Chimney Drain Height = 7.12 ft  
 Roll Width = 4 ft  
 On Center = 10 ft  
 Alternate Drain  
 Back of Infill Soil

AB Classic  
**Section 11 of 18**  
 Section 318 ft - 362.1 ft

**Base Information:**  
 Base Width: 2 ft  
 Base Depth: 0.5 ft  
 Base From Toe: 0.5 ft

**Geogrid Information:**  
 8 x Strata SG 200 @ 7 ft  
 Number Of Geogrid 8

**Allan Block Disclaimer:**

Allan Block provides this software as a service for its clients. The sole purpose of this software is to assist engineers in the design of mechanically stabilized retaining walls. The software uses evaluation techniques and engineering principles found in the Allan Block Engineering Manual. (Refer to R0904 and supporting references.) It is the responsibility of the engineer of record to determine the propriety and accuracy of input parameters and to review and verify the correctness of the results. ALLAN BLOCK CORPORATION, ITS LICENSEES OR AGENTS DO NOT ASSUME ANY LIABILITY OR RESPONSIBILITY FOR DAMAGES WHICH MAY RESULT FROM THE USE OR MISUSE OF THIS SOFTWARE.

This software only considers internal, external and internal compound stability (ICS) of the reinforced composite mass. The internal compound stability calculations are limited to an evaluation zone above the base material and back no further than 2 \* H or He + L, whichever is greater. This program DOES NOT address global stability, defined as soil stability below the base material and beyond the limits for internal compound stability. Global Stability should be evaluated to determine if the overall site is stable. It is the responsibility of the owner to ensure the global stability is analyzed. The engineer of record must evaluate the project site for proper water management and all potential modes of failure within the segmental retaining wall evaluation zone. The geotechnical engineering firm contracted by the owner should provide a full global stability opinion of the site including the effects on the segmental retaining wall.

AB Walls contains DEFAULT values for all data inputs that the user MUST change or verify as appropriate for the project conditions being analyzed. These DEFAULT values do NOT ensure a conservative design for any site condition. The final design must provide for proper wall drainage to prevent the buildup of hydrostatic pressures over the service life of the structure. In the event additional water is introduced into the general wall area, either above or below grade, any designs from this software would be invalid unless otherwise noted by the engineer of record. It is also recommended that an independent assessment of the foundation soil for settlement potential and wall deflections for the proposed structure be performed. Changes in the subsoil conditions are not included in this software. These additional potential failure modes should be evaluated by the engineer of record prior to initiating wall construction and may require site inspection by the on-site soils engineer. All installations must conform to the Allan Block Spec Book. (Refer to R0901).

MathCAD files for hand calculations to support the software's consideration of internal, external and internal compound stability of the reinforced composite mass are provided in the AB Resources Drop Down Menu. These files are to be configured so that the engineer of record can evaluate the output of the software. Individual equations may be altered at the discretion of the engineer of record.

**Wall Design Variables**

<p><b>AB Classic</b>          Section Height 10.17 ft          Total Panel Height 10.17 ft          0.635 ft          Angle of Setback 6 Deg.          Depth of Block 0.97 ft          Length of Block 1.47 ft</p>
<p><b>Surcharge Parameters</b>          100 psf Live Load @ 2.4 ft          (Distance measured from toe of wall)</p>
<p><b>Safety Factors Static External</b>          Actual Sliding          2.61 &gt;= 1.5          Actual Overturning          5.48 &gt;= 2</p>
<p><b>Infill Soil</b>          Friction Angle 30 Deg.          Unit WT 120 pcf</p>
<p><b>Retained Soil</b>          Friction Angle 26 Deg.          Unit WT 120 pcf</p>
<p><b>Foundation Soil</b>          Friction Angle 30 Deg.          Unit WT 120 pcf          Cohesion 0 psf</p>
<p><b>Bearing Capacity</b>          Factor of Safety 3.6          Sigma_ult - 4722.7 psf          Sigma_max - 1310.96 psf</p>
<p><b>Internal Compound Stability</b>          Factor of Safety 1.99          Course Number 0</p>
<p><b>Wall Rock Requirements</b>          Continuous Minimum Depth = 1 ft</p>

Project Name: clinton commons  
 Location: 65 1/2 Center Street  
 Location: Hunderdon, NJ  
 Wall Number: 4  
 Project Number:  
 Designer: Bern Oles  
 Date: 4 18 22

I hereby certify that these calculations were prepared by me or under my direct supervision and that I am a duly licensed engineer certified and responsible for the content of these calculations.

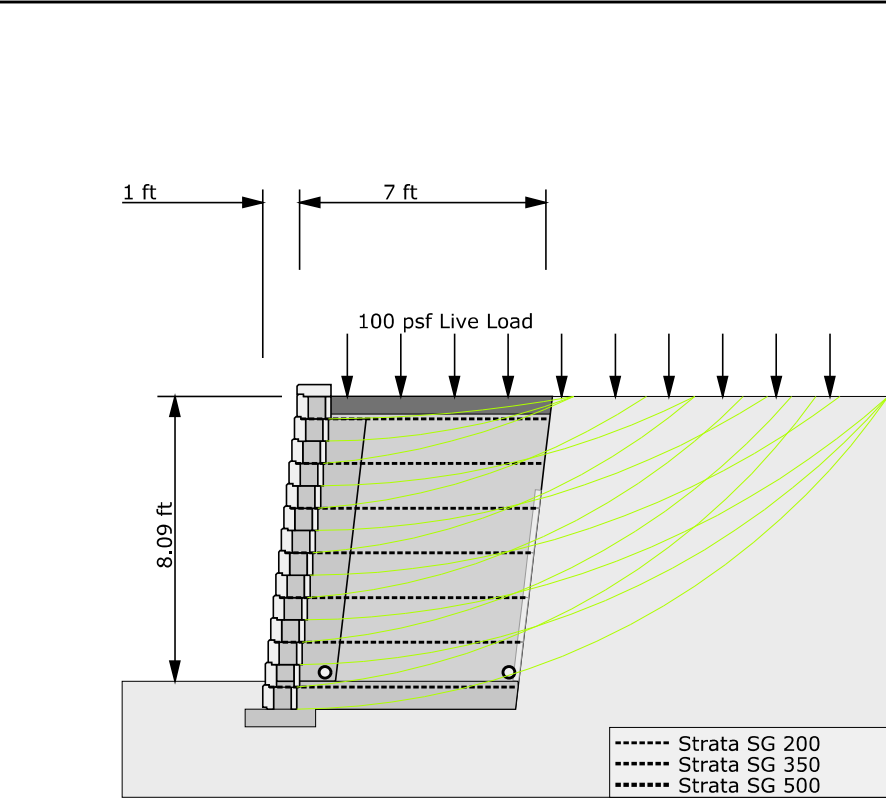
Signature:

Engineer: James Brown

24GE03107100 Date:

Page #:

31



**Section Notes**

- 1 - test this 1
- 2 - test this 3
- 3 - test this 3

**Wall Drain Options**  
 Infill Cap  
 Manufactured Drain Composite  
 Chimney Drain Height = 6.23 ft  
 Roll Width = 4 ft  
 On Center = 10 ft  
 Alternate Drain  
 Back of Infill Soil

AB Classic  
**Section 12 of 18**  
 Section 362.1 ft - 384.1 ft

**Base Information:**  
 Base Width: 2 ft  
 Base Depth: 0.5 ft  
 Base From Toe: 0.5 ft

**Geogrid Information:**  
 7 x Strata SG 200 @ 7 ft  
 Number Of Geogrid 7

**Allan Block Disclaimer:**

Allan Block provides this software as a service for its clients. The sole purpose of this software is to assist engineers in the design of mechanically stabilized retaining walls. The software uses evaluation techniques and engineering principles found in the Allan Block Engineering Manual. (Refer to R0904 and supporting references.) It is the responsibility of the engineer of record to determine the propriety and accuracy of input parameters and to review and verify the correctness of the results. ALLAN BLOCK CORPORATION, ITS LICENSEES OR AGENTS DO NOT ASSUME ANY LIABILITY OR RESPONSIBILITY FOR DAMAGES WHICH MAY RESULT FROM THE USE OR MISUSE OF THIS SOFTWARE.

This software only considers internal, external and internal compound stability (ICS) of the reinforced composite mass. The internal compound stability calculations are limited to an evaluation zone above the base material and back no further than 2 \* H or He + L, whichever is greater. This program DOES NOT address global stability, defined as soil stability below the base material and beyond the limits for internal compound stability. Global Stability should be evaluated to determine if the overall site is stable. It is the responsibility of the owner to ensure the global stability is analyzed. The engineer of record must evaluate the project site for proper water management and all potential modes of failure within the segmental retaining wall evaluation zone. The geotechnical engineering firm contracted by the owner should provide a full global stability opinion of the site including the effects on the segmental retaining wall.

AB Walls contains DEFAULT values for all data inputs that the user MUST change or verify as appropriate for the project conditions being analyzed. These DEFAULT values do NOT ensure a conservative design for any site condition. The final design must provide for proper wall drainage to prevent the buildup of hydrostatic pressures over the service life of the structure. In the event additional water is introduced into the general wall area, either above or below grade, any designs from this software would be invalid unless otherwise noted by the engineer of record. It is also recommended that an independent assessment of the foundation soil for settlement potential and wall deflections for the proposed structure be performed. Changes in the subsoil conditions are not included in this software. These additional potential failure modes should be evaluated by the engineer of record prior to initiating wall construction and may require site inspection by the on-site soils engineer. All installations must conform to the Allan Block Spec Book. (Refer to R0901).

MathCAD files for hand calculations to support the software's consideration of internal, external and internal compound stability of the reinforced composite mass are provided in the AB Resources Drop Down Menu. These files are to be configured so that the engineer of record can evaluate the output of the software. Individual equations may be altered at the discretion of the engineer of record.

<b>Wall Design Variables</b>
<b>AB Classic</b> Section Height 8.9 ft Total Panel Height 8.9 ft 0.635 ft Angle of Setback 6 Deg. Depth of Block 0.97 ft Length of Block 1.47 ft
<b>Surcharge Parameters</b> 100 psf Live Load @ 2.4 ft (Distance measured from toe of wall)
<b>Safety Factors Static External</b> Actual Sliding 2.9 >= 1.5 Actual Overturning 6.75 >= 2
<b>Infill Soil</b> Friction Angle 30 Deg. Unit WT 120 pcf
<b>Retained Soil</b> Friction Angle 26 Deg. Unit WT 120 pcf
<b>Foundation Soil</b> Friction Angle 30 Deg. Unit WT 120 pcf Cohesion 0 psf
<b>Bearing Capacity</b> Factor of Safety 4.15 Sigma_ult - 4722.7 psf Sigma_max - 1137.71 psf
<b>Internal Compound Stability</b> Factor of Safety 2.18 Course Number 0
<b>Wall Rock Requirements</b> Continuous Minimum Depth = 1 ft

Project Name: clinton commons  
 Location: 65 1/2 Center Street  
 Location: Hunderdon, NJ  
 Wall Number: 4  
 Project Number:  
 Designer: Bern Oles  
 Date: 4 18 22

I hereby certify that these calculations were prepared by me or under my direct supervision and that I am a duly licensed engineer certified and responsible for the content of these calculations.

Signature:

Engineer: James Brown

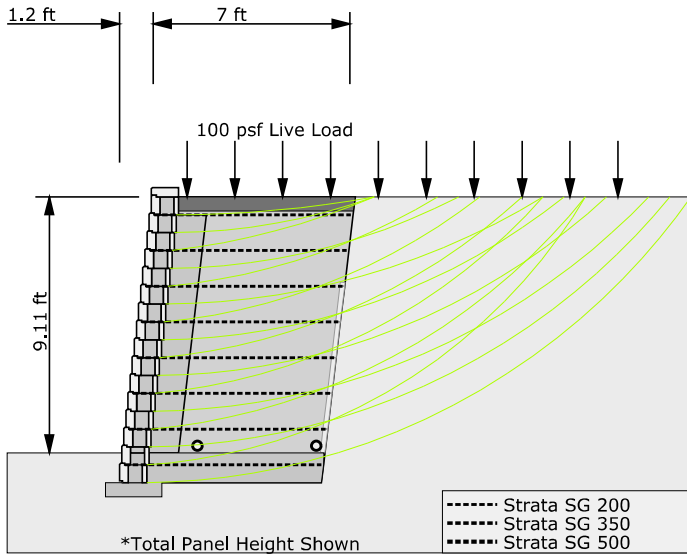
24GE03107100 Date:

Page #:  
**32**



**Section Notes**

- 1 - test this 1
- 2 - test this 3
- 3 - test this 3



**Wall Drain Options**  
 Infill Cap  
 Manufactured Drain Composite  
 Chimney Drain Height = 7.12 ft  
 Roll Width = 4 ft  
 On Center = 10 ft  
 Alternate Drain  
 Back of Infill Soil

AB Classic  
**Section 13 of 18**  
 Section 384.1 ft - 437.8 ft

**Base Information:**  
 Base Width: 2 ft  
 Base Depth: 0.5 ft  
 Base From Toe: 0.5 ft

**Geogrid Information:**  
 8 x Strata SG 200 @ 7 ft  
 Number Of Geogrid 8

**Allan Block Disclaimer:**

Allan Block provides this software as a service for its clients. The sole purpose of this software is to assist engineers in the design of mechanically stabilized retaining walls. The software uses evaluation techniques and engineering principles found in the Allan Block Engineering Manual. (Refer to R0904 and supporting references.) It is the responsibility of the engineer of record to determine the propriety and accuracy of input parameters and to review and verify the correctness of the results. ALLAN BLOCK CORPORATION, ITS LICENSEES OR AGENTS DO NOT ASSUME ANY LIABILITY OR RESPONSIBILITY FOR DAMAGES WHICH MAY RESULT FROM THE USE OR MISUSE OF THIS SOFTWARE.

This software only considers internal, external and internal compound stability (ICS) of the reinforced composite mass. The internal compound stability calculations are limited to an evaluation zone above the base material and back no further than 2 \* H or He + L, whichever is greater. This program DOES NOT address global stability, defined as soil stability below the base material and beyond the limits for internal compound stability. Global Stability should be evaluated to determine if the overall site is stable. It is the responsibility of the owner to ensure the global stability is analyzed. The engineer of record must evaluate the project site for proper water management and all potential modes of failure within the segmental retaining wall evaluation zone. The geotechnical engineering firm contracted by the owner should provide a full global stability opinion of the site including the effects on the segmental retaining wall.

AB Walls contains DEFAULT values for all data inputs that the user MUST change or verify as appropriate for the project conditions being analyzed. These DEFAULT values do NOT ensure a conservative design for any site condition. The final design must provide for proper wall drainage to prevent the buildup of hydrostatic pressures over the service life of the structure. In the event additional water is introduced into the general wall area, either above or below grade, any designs from this software would be invalid unless otherwise noted by the engineer of record. It is also recommended that an independent assessment of the foundation soil for settlement potential and wall deflections for the proposed structure be performed. Changes in the subsoil conditions are not included in this software. These additional potential failure modes should be evaluated by the engineer of record prior to initiating wall construction and may require site inspection by the on-site soils engineer. All installations must conform to the Allan Block Spec Book. (Refer to R0901).

MathCAD files for hand calculations to support the software's consideration of internal, external and internal compound stability of the reinforced composite mass are provided in the AB Resources Drop Down Menu. These files are to be configured so that the engineer of record can evaluate the output of the software. Individual equations may be altered at the discretion of the engineer of record.

**Wall Design Variables**

**AB Classic**

Section Height 9.53 ft  
 Total Panel Height 10.17 ft  
 0.635 ft  
 Angle of Setback 6 Deg.  
 Depth of Block 0.97 ft  
 Length of Block 1.47 ft

**Surcharge Parameters**

100 psf Live Load @ 2.4 ft  
 (Distance measured from toe of wall)

**Safety Factors Static External**

Actual Sliding  
 2.61 >= 1.5  
 Actual Overturning  
 5.48 >= 2

**Infill Soil**

Friction Angle 30 Deg.  
 Unit WT 120 pcf

**Retained Soil**

Friction Angle 26 Deg.  
 Unit WT 120 pcf

**Foundation Soil**

Friction Angle 30 Deg.  
 Unit WT 120 pcf  
 Cohesion 0 psf

**Bearing Capacity**

Factor of Safety 4.04  
 Sigma\_ult - 5297.95 psf  
 Sigma\_max - 1310.96 psf

**Internal Compound Stability**

Factor of Safety 1.99  
 Course Number 0

**Wall Rock Requirements**

Continuous Minimum Depth = 1 ft

I hereby certify that these calculations were prepared by me or under my direct supervision and that I am a duly licensed engineer certified and responsible for the content of these calculations.

Signature:

Engineer: James Brown

24GE03107100 Date:

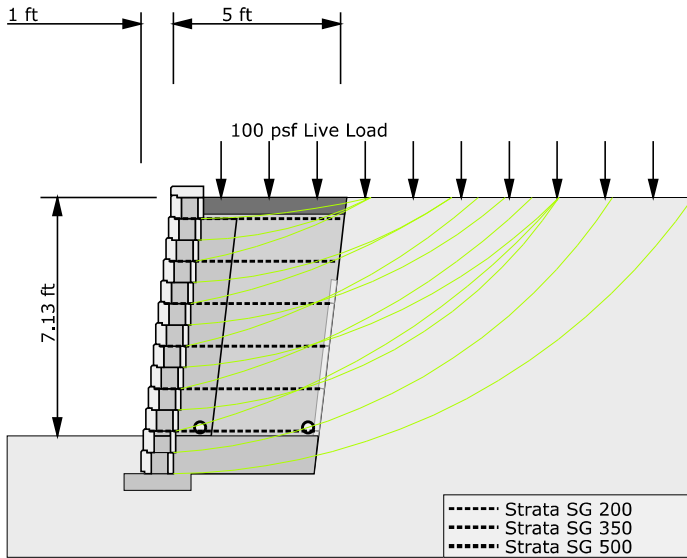
Project Name: clinton commons  
 Location: 65 1/2 Center Street  
 Location: Hunderdon, NJ  
 Wall Number: 4  
 Project Number:  
 Designer: Bern Oles  
 Date: 4 18 22

Page #:

33

**Section Notes**

- 1 - test this 1
- 2 - test this 3
- 3 - test this 3



**Wall Drain Options**  
 Infill Cap  
 Manufactured Drain Composite  
 Chimney Drain Height = 5.78 ft  
 Roll Width = 4 ft  
 On Center = 10 ft  
 Alternate Drain  
 Back of Infill Soil

AB Classic  
**Section 14 of 18**  
 Section 437.8 ft - 456.1 ft

**Base Information:**  
 Base Width: 2 ft  
 Base Depth: 0.5 ft  
 Base From Toe: 0.5 ft

**Geogrid Information:**  
 6 x Strata SG 200 @ 5 ft  
 Number Of Geogrid 6

**Allan Block Disclaimer:**

Allan Block provides this software as a service for its clients. The sole purpose of this software is to assist engineers in the design of mechanically stabilized retaining walls. The software uses evaluation techniques and engineering principles found in the Allan Block Engineering Manual. (Refer to R0904 and supporting references.) It is the responsibility of the engineer of record to determine the propriety and accuracy of input parameters and to review and verify the correctness of the results. ALLAN BLOCK CORPORATION, ITS LICENSEES OR AGENTS DO NOT ASSUME ANY LIABILITY OR RESPONSIBILITY FOR DAMAGES WHICH MAY RESULT FROM THE USE OR MISUSE OF THIS SOFTWARE.

This software only considers internal, external and internal compound stability (ICS) of the reinforced composite mass. The internal compound stability calculations are limited to an evaluation zone above the base material and back no further than 2 \* H or He + L, whichever is greater. This program DOES NOT address global stability, defined as soil stability below the base material and beyond the limits for internal compound stability. Global Stability should be evaluated to determine if the overall site is stable. It is the responsibility of the owner to ensure the global stability is analyzed. The engineer of record must evaluate the project site for proper water management and all potential modes of failure within the segmental retaining wall evaluation zone. The geotechnical engineering firm contracted by the owner should provide a full global stability opinion of the site including the effects on the segmental retaining wall.

AB Walls contains DEFAULT values for all data inputs that the user MUST change or verify as appropriate for the project conditions being analyzed. These DEFAULT values do NOT ensure a conservative design for any site condition. The final design must provide for proper wall drainage to prevent the buildup of hydrostatic pressures over the service life of the structure. In the event additional water is introduced into the general wall area, either above or below grade, any designs from this software would be invalid unless otherwise noted by the engineer of record. It is also recommended that an independent assessment of the foundation soil for settlement potential and wall deflections for the proposed structure be performed. Changes in the subsoil conditions are not included in this software. These additional potential failure modes should be evaluated by the engineer of record prior to initiating wall construction and may require site inspection by the on-site soils engineer. All installations must conform to the Allan Block Spec Book. (Refer to R0901).

MathCAD files for hand calculations to support the software's consideration of internal, external and internal compound stability of the reinforced composite mass are provided in the AB Resources Drop Down Menu. These files are to be configured so that the engineer of record can evaluate the output of the software. Individual equations may be altered at the discretion of the engineer of record.

**Wall Design Variables**

**AB Classic**

Section Height 8.26 ft  
 Total Panel Height 8.26 ft  
 0.635 ft  
 Angle of Setback 6 Deg.  
 Depth of Block 0.97 ft  
 Length of Block 1.47 ft

**Surcharge Parameters**

100 psf Live Load @ 2.4 ft  
 (Distance measured from toe of wall)

**Safety Factors Static External**

Actual Sliding  
 2.27 >= 1.5  
 Actual Overturning  
 4.27 >= 2

**Infill Soil**

Friction Angle 30 Deg.  
 Unit WT 120 pcf

**Retained Soil**

Friction Angle 26 Deg.  
 Unit WT 120 pcf

**Foundation Soil**

Friction Angle 30 Deg.  
 Unit WT 120 pcf  
 Cohesion 0 psf

**Bearing Capacity**

Factor of Safety 4.49  
 Sigma\_ult - 5452.28 psf  
 Sigma\_max - 1214.24 psf

**Internal Compound Stability**

Factor of Safety 1.82  
 Course Number 0

**Wall Rock Requirements**

Continuous Minimum Depth = 1 ft

I hereby certify that these calculations were prepared by me or under my direct supervision and that I am a duly licensed engineer certified and responsible for the content of these calculations.

Signature:

Engineer: James Brown

24GE03107100 Date:

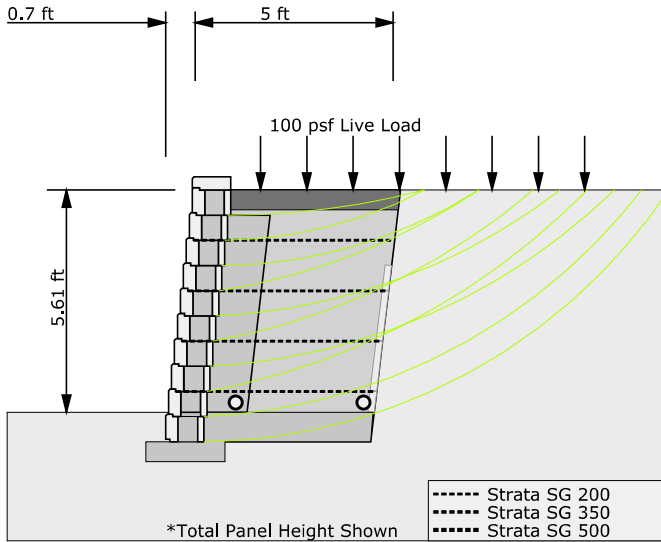
Project Name: clinton commons  
 Location: 65 1/2 Center Street  
 Location: Hunderdon, NJ  
 Wall Number: 4  
 Project Number:  
 Designer: Bern Oles  
 Date: 4 18 22

Page #:

34

**Section Notes**

- 1 - test this 1
- 2 - test this 3
- 3 - test this 3



**Wall Drain Options**

- Infill Cap
- Manufactured Drain Composite
- Chimney Drain Height = 4.45 ft
- Roll Width = 4 ft
- On Center = 10 ft
- Alternate Drain
- Back of Infill Soil

AB Classic  
**Section 15 of 18**  
 Section 456.1 ft - 473.8 ft

**Base Information:**  
 Base Width: 2 ft  
 Base Depth: 0.5 ft  
 Base From Toe: 0.5 ft

**Geogrid Information:**  
 4 x Strata SG 200 @ 5 ft  
 Number Of Geogrid 4

**Allan Block Disclaimer:**

Allan Block provides this software as a service for its clients. The sole purpose of this software is to assist engineers in the design of mechanically stabilized retaining walls. The software uses evaluation techniques and engineering principles found in the Allan Block Engineering Manual. (Refer to R0904 and supporting references.) It is the responsibility of the engineer of record to determine the propriety and accuracy of input parameters and to review and verify the correctness of the results. ALLAN BLOCK CORPORATION, ITS LICENSEES OR AGENTS DO NOT ASSUME ANY LIABILITY OR RESPONSIBILITY FOR DAMAGES WHICH MAY RESULT FROM THE USE OR MISUSE OF THIS SOFTWARE.

This software only considers internal, external and internal compound stability (ICS) of the reinforced composite mass. The internal compound stability calculations are limited to an evaluation zone above the base material and back no further than 2 \* H or He + L, whichever is greater. This program DOES NOT address global stability, defined as soil stability below the base material and beyond the limits for internal compound stability. Global Stability should be evaluated to determine if the overall site is stable. It is the responsibility of the owner to ensure the global stability is analyzed. The engineer of record must evaluate the project site for proper water management and all potential modes of failure within the segmental retaining wall evaluation zone. The geotechnical engineering firm contracted by the owner should provide a full global stability opinion of the site including the effects on the segmental retaining wall.

AB Walls contains DEFAULT values for all data inputs that the user MUST change or verify as appropriate for the project conditions being analyzed. These DEFAULT values do NOT ensure a conservative design for any site condition. The final design must provide for proper wall drainage to prevent the buildup of hydrostatic pressures over the service life of the structure. In the event additional water is introduced into the general wall area, either above or below grade, any designs from this software would be invalid unless otherwise noted by the engineer of record. It is also recommended that an independent assessment of the foundation soil for settlement potential and wall deflections for the proposed structure be performed. Changes in the subsoil conditions are not included in this software. These additional potential failure modes should be evaluated by the engineer of record prior to initiating wall construction and may require site inspection by the on-site soils engineer. All installations must conform to the Allan Block Spec Book. (Refer to R0901).

MathCAD files for hand calculations to support the software's consideration of internal, external and internal compound stability of the reinforced composite mass are provided in the AB Resources Drop Down Menu. These files are to be configured so that the engineer of record can evaluate the output of the software. Individual equations may be altered at the discretion of the engineer of record.

**Wall Design Variables**

**AB Classic**

Section Height 5.72 ft  
 Total Panel Height 6.35 ft  
 0.635 ft  
 Angle of Setback 6 Deg.  
 Depth of Block 0.97 ft  
 Length of Block 1.47 ft

**Surcharge Parameters**

100 psf Live Load @ 2.4 ft  
 (Distance measured from toe of wall)

**Safety Factors Static External**

Actual Sliding  
 2.77 >= 1.5  
 Actual Overturning  
 6.35 >= 2

**Infill Soil**

Friction Angle 30 Deg.  
 Unit WT 120 pcf

**Retained Soil**

Friction Angle 26 Deg.  
 Unit WT 120 pcf

**Foundation Soil**

Friction Angle 30 Deg.  
 Unit WT 120 pcf  
 Cohesion 0 psf

**Bearing Capacity**

Factor of Safety 5.64  
 Sigma\_ult - 4596.42 psf  
 Sigma\_max - 815.2 psf

**Internal Compound Stability**

Factor of Safety 1.99  
 Course Number 0

**Wall Rock Requirements**

Continuous Minimum Depth = 1 ft

I hereby certify that these calculations were prepared by me or under my direct supervision and that I am a duly licensed engineer certified and responsible for the content of these calculations.

Signature:

Engineer: James Brown

24GE03107100 Date:

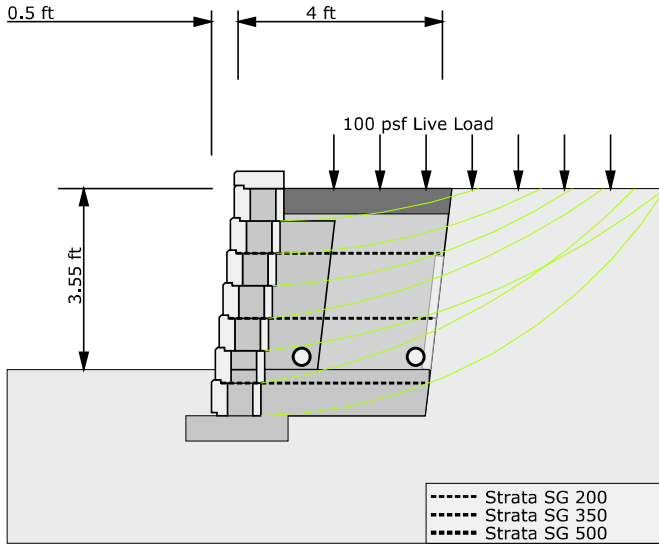
Project Name: clinton commons  
 Location: 65 1/2 Center Street  
 Location: Hunderdon, NJ  
 Wall Number: 4  
 Project Number:  
 Designer: Bern Oles  
 Date: 4 18 22

Page #:

**35**

**Section Notes**

- 1 - test this 1
- 2 - test this 3
- 3 - test this 3



**Wall Drain Options**

- Infill Cap
- Manufactured Drain Composite
- Chimney Drain Height = 3.11 ft
- Roll Width = 4 ft
- On Center = 10 ft
- Alternate Drain
- Back of Infill Soil

AB Classic  
**Section 16 of 18**  
 Section 473.8 ft - 479.6 ft

**Base Information:**  
 Base Width: 2 ft  
 Base Depth: 0.5 ft  
 Base From Toe: 0.5 ft

**Geogrid Information:**  
 3 x Strata SG 200 @ 4 ft  
 Number Of Geogrid 3

**Allan Block Disclaimer:**

Allan Block provides this software as a service for its clients. The sole purpose of this software is to assist engineers in the design of mechanically stabilized retaining walls. The software uses evaluation techniques and engineering principles found in the Allan Block Engineering Manual. (Refer to R0904 and supporting references.) It is the responsibility of the engineer of record to determine the propriety and accuracy of input parameters and to review and verify the correctness of the results. ALLAN BLOCK CORPORATION, ITS LICENSEES OR AGENTS DO NOT ASSUME ANY LIABILITY OR RESPONSIBILITY FOR DAMAGES WHICH MAY RESULT FROM THE USE OR MISUSE OF THIS SOFTWARE.

This software only considers internal, external and internal compound stability (ICS) of the reinforced composite mass. The internal compound stability calculations are limited to an evaluation zone above the base material and back no further than 2 \* H or He + L, whichever is greater. This program DOES NOT address global stability, defined as soil stability below the base material and beyond the limits for internal compound stability. Global Stability should be evaluated to determine if the overall site is stable. It is the responsibility of the owner to ensure the global stability is analyzed. The engineer of record must evaluate the project site for proper water management and all potential modes of failure within the segmental retaining wall evaluation zone. The geotechnical engineering firm contracted by the owner should provide a full global stability opinion of the site including the effects on the segmental retaining wall.

AB Walls contains DEFAULT values for all data inputs that the user MUST change or verify as appropriate for the project conditions being analyzed. These DEFAULT values do NOT ensure a conservative design for any site condition. The final design must provide for proper wall drainage to prevent the buildup of hydrostatic pressures over the service life of the structure. In the event additional water is introduced into the general wall area, either above or below grade, any designs from this software would be invalid unless otherwise noted by the engineer of record. It is also recommended that an independent assessment of the foundation soil for settlement potential and wall deflections for the proposed structure be performed. Changes in the subsoil conditions are not included in this software. These additional potential failure modes should be evaluated by the engineer of record prior to initiating wall construction and may require site inspection by the on-site soils engineer. All installations must conform to the Allan Block Spec Book. (Refer to R0901).

MathCAD files for hand calculations to support the software's consideration of internal, external and internal compound stability of the reinforced composite mass are provided in the AB Resources Drop Down Menu. These files are to be configured so that the engineer of record can evaluate the output of the software. Individual equations may be altered at the discretion of the engineer of record.

**Wall Design Variables**

**AB Classic**

Section Height 4.45 ft  
 Total Panel Height 4.45 ft  
 0.635 ft  
 Angle of Setback 6 Deg.  
 Depth of Block 0.97 ft  
 Length of Block 1.47 ft

**Surcharge Parameters**

100 psf Live Load @ 2.4 ft  
 (Distance measured from toe of wall)

**Safety Factors Static External**

Actual Sliding  
 2.92 >= 1.5  
 Actual Overturning  
 7.34 >= 2

**Infill Soil**

Friction Angle 30 Deg.  
 Unit WT 120 pcf

**Retained Soil**

Friction Angle 26 Deg.  
 Unit WT 120 pcf

**Foundation Soil**

Friction Angle 30 Deg.  
 Unit WT 120 pcf  
 Cohesion 0 psf

**Bearing Capacity**

Factor of Safety 8.7  
 Sigma\_ult - 4947.18 psf  
 Sigma\_max - 568.53 psf

**Internal Compound Stability**

Factor of Safety 2.89  
 Course Number 0

**Wall Rock Requirements**

Continuous Minimum Depth = 1 ft

I hereby certify that these calculations were prepared by me or under my direct supervision and that I am a duly licensed engineer certified and responsible for the content of these calculations.

Signature:

Engineer: James Brown

24GE03107100 Date:

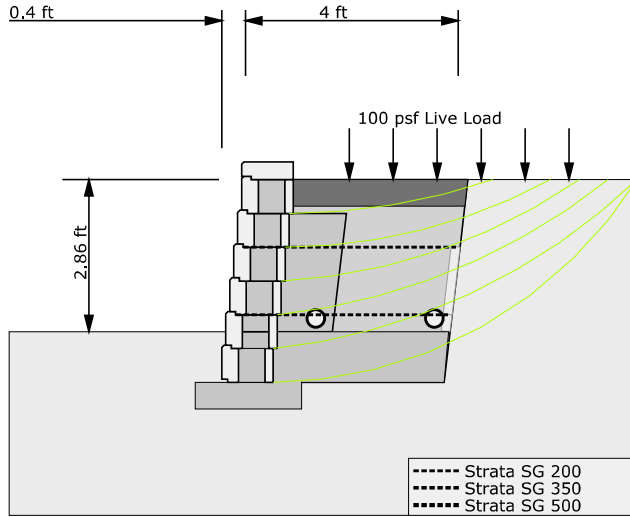
Project Name: clinton commons  
 Location: 65 1/2 Center Street  
 Location: Hunderdon, NJ  
 Wall Number: 4  
 Project Number:  
 Designer: Bern Oles  
 Date: 4 18 22

Page #:

36

**Section Notes**

- 1 - test this 1
- 2 - test this 3
- 3 - test this 3



**Wall Drain Options**

- Infill Cap
- Manufactured Drain Composite
- Chimney Drain Height = 2.67 ft
- Roll Width = 4 ft
- On Center = 10 ft
- Alternate Drain
- Back of Infill Soil

AB Classic  
**Section 17 of 18**  
 Section 479.6 ft - 485.5 ft

**Base Information:**  
 Base Width: 2 ft  
 Base Depth: 0.5 ft  
 Base From Toe: 0.5 ft

**Geogrid Information:**  
 2 x Strata SG 200 @ 4 ft  
 Number Of Geogrid 2

**Allan Block Disclaimer:**

Allan Block provides this software as a service for its clients. The sole purpose of this software is to assist engineers in the design of mechanically stabilized retaining walls. The software uses evaluation techniques and engineering principles found in the Allan Block Engineering Manual. (Refer to R0904 and supporting references.) It is the responsibility of the engineer of record to determine the propriety and accuracy of input parameters and to review and verify the correctness of the results. ALLAN BLOCK CORPORATION, ITS LICENSEES OR AGENTS DO NOT ASSUME ANY LIABILITY OR RESPONSIBILITY FOR DAMAGES WHICH MAY RESULT FROM THE USE OR MISUSE OF THIS SOFTWARE.

This software only considers internal, external and internal compound stability (ICS) of the reinforced composite mass. The internal compound stability calculations are limited to an evaluation zone above the base material and back no further than 2 \* H or He + L, whichever is greater. This program DOES NOT address global stability, defined as soil stability below the base material and beyond the limits for internal compound stability. Global Stability should be evaluated to determine if the overall site is stable. It is the responsibility of the owner to ensure the global stability is analyzed. The engineer of record must evaluate the project site for proper water management and all potential modes of failure within the segmental retaining wall evaluation zone. The geotechnical engineering firm contracted by the owner should provide a full global stability opinion of the site including the effects on the segmental retaining wall.

AB Walls contains DEFAULT values for all data inputs that the user MUST change or verify as appropriate for the project conditions being analyzed. These DEFAULT values do NOT ensure a conservative design for any site condition. The final design must provide for proper wall drainage to prevent the buildup of hydrostatic pressures over the service life of the structure. In the event additional water is introduced into the general wall area, either above or below grade, any designs from this software would be invalid unless otherwise noted by the engineer of record. It is also recommended that an independent assessment of the foundation soil for settlement potential and wall deflections for the proposed structure be performed. Changes in the subsoil conditions are not included in this software. These additional potential failure modes should be evaluated by the engineer of record prior to initiating wall construction and may require site inspection by the on-site soils engineer. All installations must conform to the Allan Block Spec Book. (Refer to R0901).

MathCAD files for hand calculations to support the software's consideration of internal, external and internal compound stability of the reinforced composite mass are provided in the AB Resources Drop Down Menu. These files are to be configured so that the engineer of record can evaluate the output of the software. Individual equations may be altered at the discretion of the engineer of record.

**Wall Design Variables**

**AB Classic**

Section Height 3.81 ft  
 Total Panel Height 3.81 ft  
 0.635 ft  
 Angle of Setback 6 Deg.  
 Depth of Block 0.97 ft  
 Length of Block 1.47 ft

**Surcharge Parameters**

100 psf Live Load @ 2.4 ft  
 (Distance measured from toe of wall)

**Safety Factors Static External**

Actual Sliding  
 3.24 >= 1.5  
 Actual Overturning  
 9.17 >= 2

**Infill Soil**

Friction Angle 30 Deg.  
 Unit WT 120 pcf

**Retained Soil**

Friction Angle 26 Deg.  
 Unit WT 120 pcf

**Foundation Soil**

Friction Angle 30 Deg.  
 Unit WT 120 pcf  
 Cohesion 0 psf

**Bearing Capacity**

Factor of Safety 10.45  
 Sigma\_ult - 5059.43 psf  
 Sigma\_max - 484.18 psf

**Internal Compound Stability**

Factor of Safety 2.54  
 Course Number 0

**Wall Rock Requirements**

Continuous Minimum Depth = 1 ft

I hereby certify that these calculations were prepared by me or under my direct supervision and that I am a duly licensed engineer certified and responsible for the content of these calculations.

Signature:

Engineer: James Brown

24GE03107100 Date:

Project Name: clinton commons  
 Location: 65 1/2 Center Street  
 Location: Hunderdon, NJ  
 Wall Number: 4  
 Project Number:  
 Designer: Bern Oles  
 Date: 4 18 22

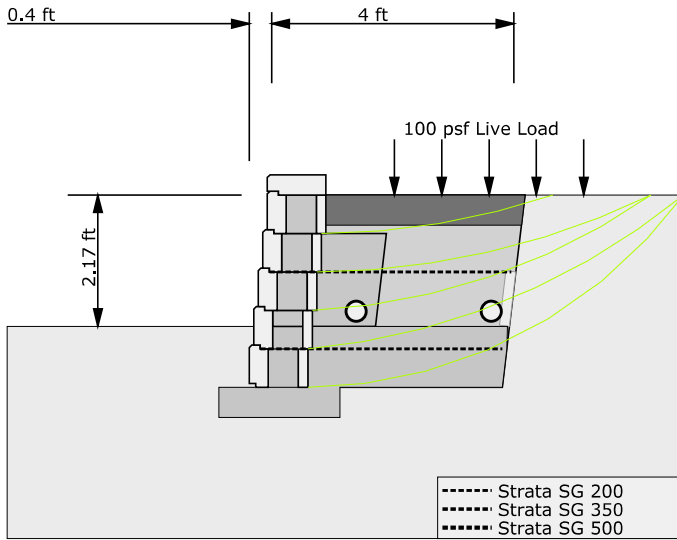
Page #:

37



**Section Notes**

- 1 - test this 1
- 2 - test this 3
- 3 - test this 3



**Wall Drain Options**

- Infill Cap
- Manufactured Drain Composite
- Chimney Drain Height = 2.22 ft
- Roll Width = 4 ft
- On Center = 10 ft
- Alternate Drain
- Back of Infill Soil

AB Classic  
**Section 18 of 18**  
 Section 485.5 ft - 487 ft

**Base Information:**  
 Base Width: 2 ft  
 Base Depth: 0.5 ft  
 Base From Toe: 0.5 ft

**Geogrid Information:**  
 2 x Strata SG 200 @ 4 ft  
 Number Of Geogrid 2

**Allan Block Disclaimer:**

Allan Block provides this software as a service for its clients. The sole purpose of this software is to assist engineers in the design of mechanically stabilized retaining walls. The software uses evaluation techniques and engineering principles found in the Allan Block Engineering Manual. (Refer to R0904 and supporting references.) It is the responsibility of the engineer of record to determine the propriety and accuracy of input parameters and to review and verify the correctness of the results. ALLAN BLOCK CORPORATION, ITS LICENSEES OR AGENTS DO NOT ASSUME ANY LIABILITY OR RESPONSIBILITY FOR DAMAGES WHICH MAY RESULT FROM THE USE OR MISUSE OF THIS SOFTWARE.

This software only considers internal, external and internal compound stability (ICS) of the reinforced composite mass. The internal compound stability calculations are limited to an evaluation zone above the base material and back no further than 2 \* H or He + L, whichever is greater. This program DOES NOT address global stability, defined as soil stability below the base material and beyond the limits for internal compound stability. Global Stability should be evaluated to determine if the overall site is stable. It is the responsibility of the owner to ensure the global stability is analyzed. The engineer of record must evaluate the project site for proper water management and all potential modes of failure within the segmental retaining wall evaluation zone. The geotechnical engineering firm contracted by the owner should provide a full global stability opinion of the site including the effects on the segmental retaining wall.

AB Walls contains DEFAULT values for all data inputs that the user MUST change or verify as appropriate for the project conditions being analyzed. These DEFAULT values do NOT ensure a conservative design for any site condition. The final design must provide for proper wall drainage to prevent the buildup of hydrostatic pressures over the service life of the structure. In the event additional water is introduced into the general wall area, either above or below grade, any designs from this software would be invalid unless otherwise noted by the engineer of record. It is also recommended that an independent assessment of the foundation soil for settlement potential and wall deflections for the proposed structure be performed. Changes in the subsoil conditions are not included in this software. These additional potential failure modes should be evaluated by the engineer of record prior to initiating wall construction and may require site inspection by the on-site soils engineer. All installations must conform to the Allan Block Spec Book. (Refer to R0901).

MathCAD files for hand calculations to support the software's consideration of internal, external and internal compound stability of the reinforced composite mass are provided in the AB Resources Drop Down Menu. These files are to be configured so that the engineer of record can evaluate the output of the software. Individual equations may be altered at the discretion of the engineer of record.

**Wall Design Variables**

**AB Classic**

Section Height 3.18 ft  
 Total Panel Height 3.18 ft  
 0.635 ft  
 Angle of Setback 6 Deg.  
 Depth of Block 0.97 ft  
 Length of Block 1.47 ft

**Surcharge Parameters**

100 psf Live Load @ 2.4 ft  
 (Distance measured from toe of wall)

**Safety Factors Static External**

Actual Sliding  
 3.64 >= 1.5  
 Actual Overturning  
 11.91 >= 2

**Infill Soil**

Friction Angle 30 Deg.  
 Unit WT 120 pcf

**Retained Soil**

Friction Angle 26 Deg.  
 Unit WT 120 pcf

**Foundation Soil**

Friction Angle 30 Deg.  
 Unit WT 120 pcf  
 Cohesion 0 psf

**Bearing Capacity**

Factor of Safety 12.9  
 Sigma\_ult - 5171.67 psf  
 Sigma\_max - 400.88 psf

**Internal Compound Stability**

Factor of Safety 3.88  
 Course Number 0

**Wall Rock Requirements**

Continuous Minimum Depth = 1 ft

Project Name: clinton commons  
 Location: 65 1/2 Center Street  
 Location: Hunderdon, NJ  
 Wall Number: 4  
 Project Number:  
 Designer: Bern Oles  
 Date: 4 18 22

I hereby certify that these calculations were prepared by me or under my direct supervision and that I am a duly licensed engineer certified and responsible for the content of these calculations.

Signature:

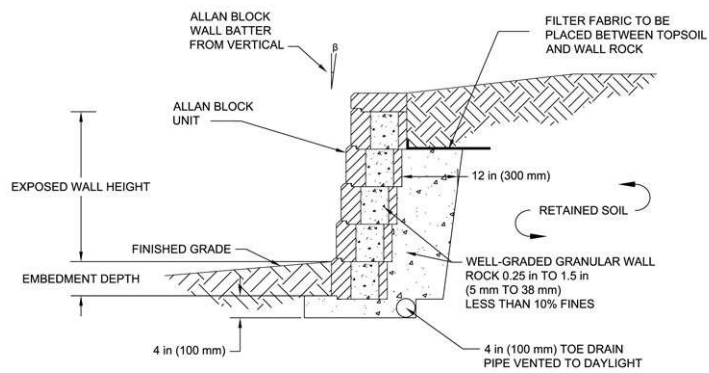
Engineer: James Brown

24GE03107100 Date:

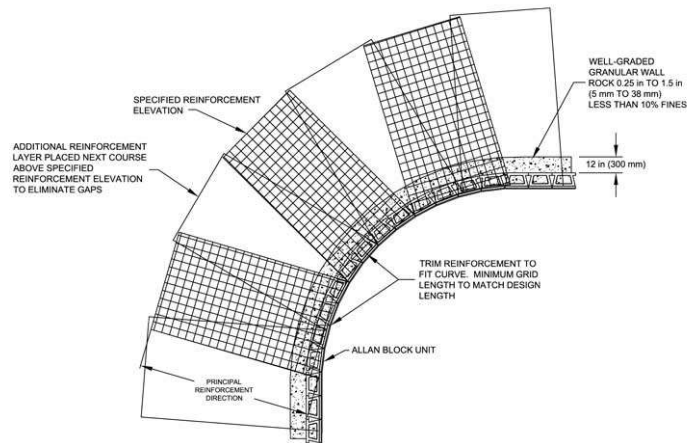
Page #:

38





**Typical Gravity Wall Section**



**Inside Curve Application**

I hereby certify that these calculations were prepared by me or under my direct supervision and that I am a duly licensed engineer certified and responsible for the content of these calculations.

Signature:

Engineer: James Brown

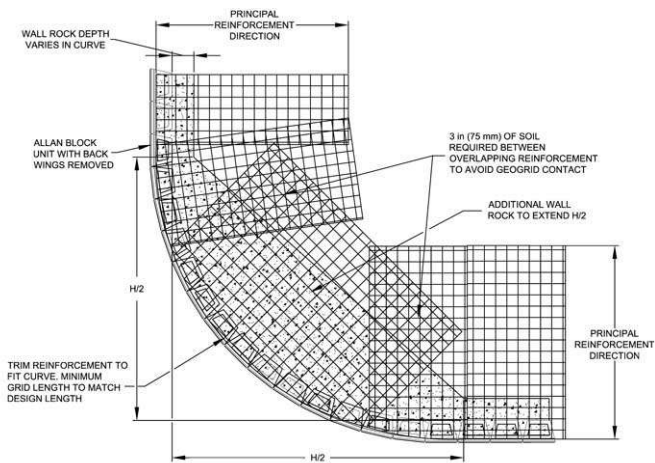
24GE03107100 Date:

Project Name: clinton commons  
 Location: 65 1/2 Center Street  
 Location: Hunderdon, NJ  
 Wall Number: 4  
 Project Number:  
 Designer: Bern Oles  
 Date: 4 18 22

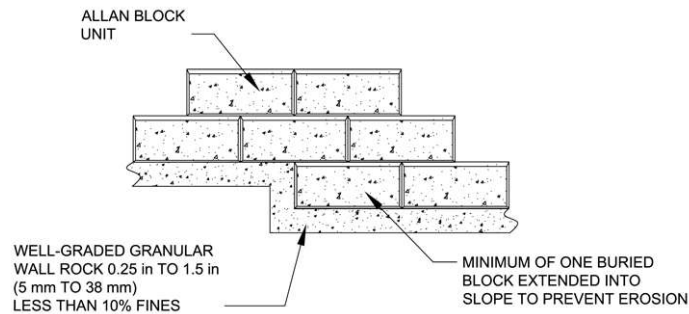
Page #:

**40**

Note: Details Not To Scale



**Outside Curve Application**



**Step-Up at Base Course**

I hereby certify that these calculations were prepared by me or under my direct supervision and that I am a duly licensed engineer certified and responsible for the content of these calculations.

Signature:

Engineer: James Brown

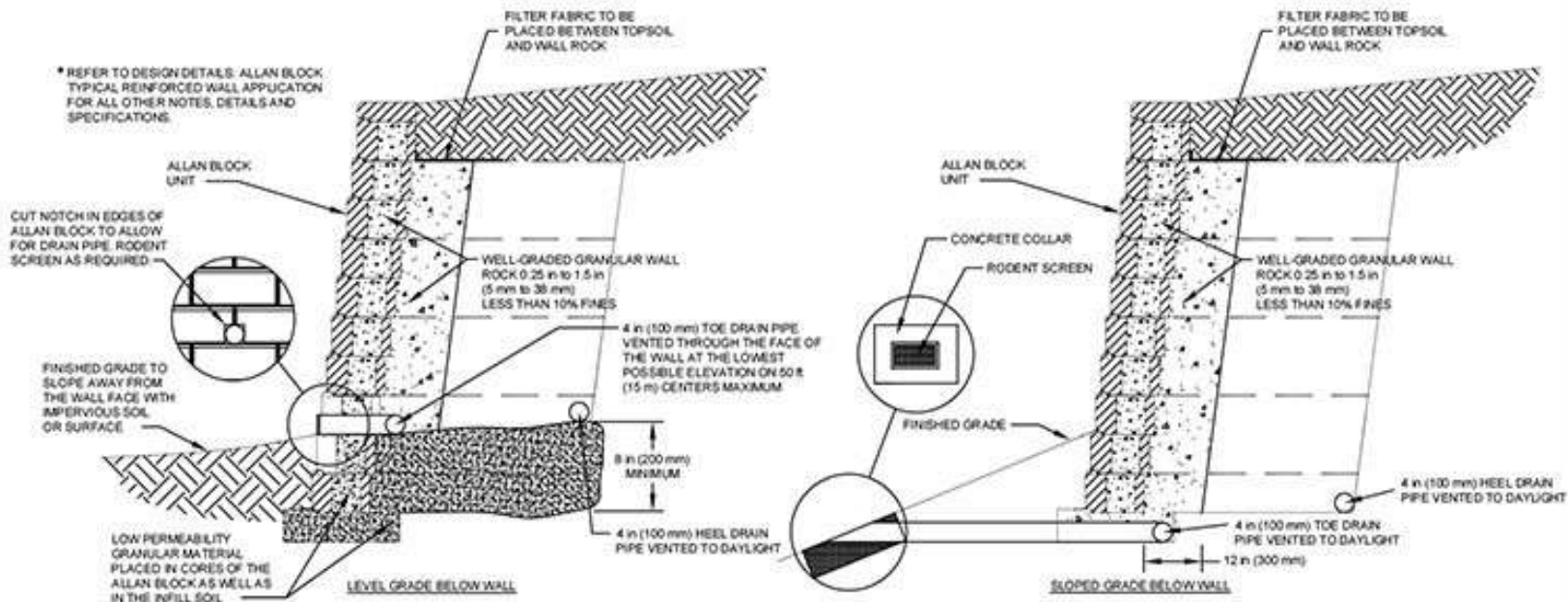
24GE03107100 Date:

Project Name: clinton commons  
 Location: 65 1/2 Center Street  
 Location: Hunderdon, NJ  
 Wall Number: 4  
 Project Number:  
 Designer: Bern Oles  
 Date: 4 18 22

Page #:

**41**

Note: Details Not To Scale



### Alternate Drain

I hereby certify that these calculations were prepared by me or under my direct supervision and that I am a duly licensed engineer certified and responsible for the content of these calculations.

Signature:

Engineer: James Brown

24GE03107100 Date:

Project Name: clinton commons  
 Location: 65 1/2 Center Street  
 Location: Hunderdon, NJ  
 Wall Number: 4  
 Project Number:  
 Designer: Bern Oles  
 Date: 4 18 22

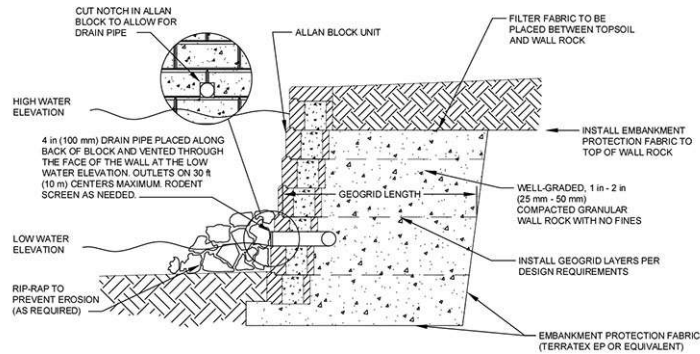
Page #:

42

Note: Details Not To Scale

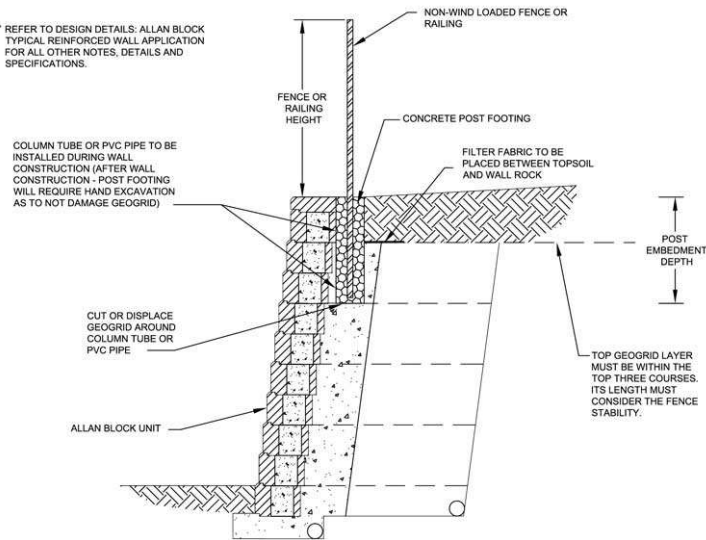


\* REFER TO DESIGN DETAILS: ALLAN BLOCK TYPICAL REINFORCED WALL APPLICATION FOR ALL OTHER NOTES, DETAILS AND SPECIFICATIONS.



**Water Application Low Wall Section**

\* REFER TO DESIGN DETAILS: ALLAN BLOCK TYPICAL REINFORCED WALL APPLICATION FOR ALL OTHER NOTES, DETAILS AND SPECIFICATIONS.



**No Wind Fence Wall Section 1**

I hereby certify that these calculations were prepared by me or under my direct supervision and that I am a duly licensed engineer certified and responsible for the content of these calculations.

Signature:

Engineer: James Brown

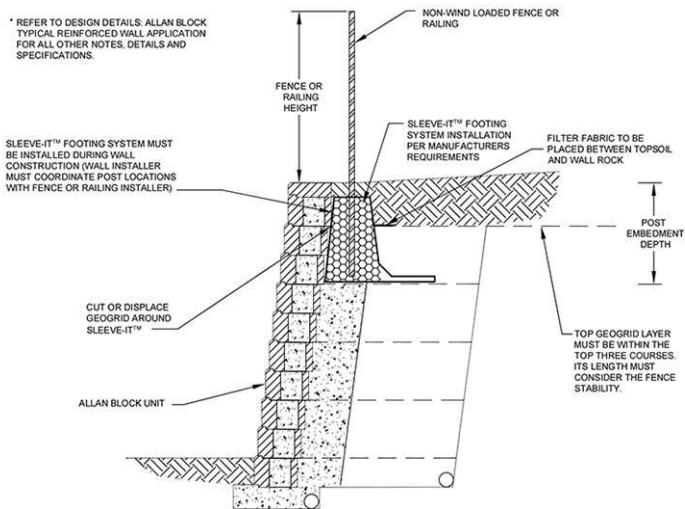
24GE03107100 Date:

Project Name: clinton commons  
 Location: 65 1/2 Center Street  
 Location: Hunderdon, NJ  
 Wall Number: 4  
 Project Number:  
 Designer: Bern Oles  
 Date: 4 18 22

Page #:

**43**

Note: Details Not To Scale



### Alternate Fence Footing with SLEEVE-IT

Note: Details Not To Scale

I hereby certify that these calculations were prepared by me or under my direct supervision and that I am a duly licensed engineer certified and responsible for the content of these calculations.

Signature:

Engineer: James Brown

24GE03107100 Date:

Project Name: clinton commons  
 Location: 65 1/2 Center Street  
 Location: Hunderdon, NJ  
 Wall Number: 4  
 Project Number:  
 Designer: Bern Oles  
 Date: 4 18 22

Page #:

**44**

# AB Wall Material and Labor Estimate Worksheet

## Material Estimate (Using Elevation View):

	Quantity	Unit	Overage	Quantity	Cost	Total
AB Classic	4493	Blocks	0 %	4493	\$0.00	\$0.00
Wall Caps	332	Blocks	0 %	332	\$0.00	\$0.00
Filter Fabric	108.22	yd^2	0 %	108.2	\$0.00	\$0.00
Strata SG 200	2262.7	yd^2	0 %	2262.7	\$0.00	\$0.00
Rock in Base	0	ton	0 %	0	\$0.00	\$0.00
Alternate Drain	158.1	ton	0 %	158.1	\$0.00	\$0.00
Wall Rock	342.1	ton	0 %	342.1	\$0.00	\$0.00
Manufactured Drain Composite	126.36	ton	0 %	126.4	\$0.00	\$0.00
1 Soil Type	700.6	yd^3	0 %	700.6	\$0.00	\$0.00
Drain Pipe	973.95	ft	0 %	974	\$0.00	\$0.00
						<b>\$0.00</b>

## Labor Estimate

	Length / Area	Unit	Cost / Hour	Total
Base Crew	487 ft	0 ft/hr	\$0.00	\$0.00
Wall Crew	3884 ft^2	0 ft^2/hr	\$0.00	\$0.00
			<b>Labor Total</b>	<b>\$0.00</b>

## Engineering Estimate

	Wall Area	Cost/ft^2	Total
Engineering Cost	4193.3 ft^2	\$0.00	\$0.00
		<b>Engineering Total</b>	<b>\$0.00</b>

**Subtotal \$0.00**  
**Profit 0 %**  
**Overhead 0 %**  
**Project Total \$0.00**  
**Cost / ft^2 \$0.00**

Block overage has not been added to the total wall area.

The accuracy and use of numbers contained in this document and program are the sole responsibility of the user of this program. Allan Block Corp. assumes no liability for the use or misuse of this worksheet. The user must verify each estimate and calculation for accuracy as they pertain to their particular project. Please note that the quantities of AB Corner units are not estimated automatically. The user must manually determine the number of AB Corner units needed for their particular project.

Project Name: clinton commons  
 Location: 65 1/2 Center Street  
 Location: Hunderdon, NJ  
 Wall Number: 4  
 Project Number:  
 Designer: Bern Oles  
 Date: 4 18 22

Page #:

45

## Appendix G

### **ANS Geo Phase II Geophysical Investigation Report**



# **GEOPHYSICAL INVESTIGATION REPORT**

**Concept Engineering Consultants**

**Clinton Commons Project**  
Clinton, New Jersey

December 23, 2022 (REV. 4)



# Table of Contents

1	Executive Summary .....	1
2	Introduction .....	2
3	Field Investigation .....	3
3.1	Electrical Resistivity Imaging (ERI) .....	3
3.2	Percussion Probes.....	4
3.3	Test Borings.....	4
3.3.1	Encountered Subsurface Conditions in Test Borings.....	5
4	Geophysical Investigation Method .....	6
4.1	Electrical Resistivity Imaging (ERI) .....	6
4.1.1	Theory.....	6
4.1.2	Methods .....	7
4.1.3	Data Collection and Data Processing .....	7
5	Background Geology .....	7
5.1	Surficial Geology.....	7
5.2	Bedrock Geology .....	7
5.3	Karst Geology.....	8
5.4	Aerial Imagery Evaluation for Previous On-Site Subsidence Events .....	8
6	Geophysical Analysis.....	9
6.1	Electrical Resistivity Imaging Analysis.....	9
6.2	Geology Analysis .....	10
7	Risk Evaluation and Conclusions .....	10
8	Limitations.....	11
9	References .....	12

## Appendices

- Appendix A – Geophysical Investigation Survey Location Plans
- Appendix B – Electrical Resistivity Imaging (ERI) Profiles
- Appendix C – Investigation Location Plan
- Appendix D – Percussion Probe Logs
- Appendix E – Test Boring Logs

## 1 Executive Summary

ANS Geo was retained by Concept Engineering Consultants to complete a broad-scale geophysical investigation to evaluate potential karst conditions at the proposed Clinton Commons project site located in the Town of Clinton, New Jersey. Our geophysical survey was completed as a supplemental investigation behind a previous investigation completed by Engineering and Land Planning Associates in June 2009 and April 2020, and ahead of an ANS Geo's 2022 Geotechnical investigation consisting of percussion probes and test borings. Through review of Engineering & Land Planning Associates 2020 "*Karstic Geology Investigation Report*", USGS NAPP color infra-red (CIR) imagery was evaluated and eight (8) possible karstic locations were delineated based off of that imagery.

Based on our review of available information, we identified the project site is mapped by the United States Geological Survey (USGS) as being underlain by the Allentown Formation and Lower Beekmantown Group consisting primarily of Dolomite with some Shale and Orthoquartzite bedding. Dolomite bedrock, while not typically as prone as Limestone, can be generally susceptible to karst. To better evaluate the presence or absence of karst anomalies at the project site, ANS Geo completed a geophysical investigation program consisting of Electrical Resistivity Imaging (ERI), to characterize the type, depth, and extent of karst features at representative locations across the site. The geophysical program was not an exhaustive evaluation of the entire site, but intended to gain a general understanding of the subsurface conditions and the impact of karst on the design, siting, and construction of the project.

ANS Geo completed the ERI geophysical survey at the project site on February 28 and March 1, 2022. In total, nine (9) ERI survey transects were completed at locations depicted as potential karst zones as well as along a northwest-southeast running fault line and within the projects planned SWM Recharge Basin.

The surveys conducted generally showed steep trends in depths between upper soil horizons, weathered bedrock, and competent bedrock. Survey interpretations identified interbedded upper clay and soil-like residuum and possible "epi-karst" consisting of a gravel-clay-sand mixture. These soil-like residuum zones were sporadic and were observed through analysis of ERI results, to different degrees, within all the profiles surveyed. Weathered top of bedrock was generally observed between ground surface and approximately 5 to 10 feet below grade. As expected, our surveys indicate that the quality of the bedrock generally improves with increased depth. Top of bedrock was moderately to highly pinnacled or abruptly changing in depth, with particular locations exhibiting possible deep soil or soil-residuum horizons, most likely caused by deep weathering of the bedrock over time and possible karst zones.

Based on our preliminary evaluation of the geophysics results, it appeared that karst may be of low-risk to design and construction within the broader project boundaries. Karst features, such as pinnacled top of bedrock, and areas of possible soil infilling were observed within the majority of the ERI profiles. Therefore, these existing conditions shall be considered for the proposed foundations of structures and design and location of proposed stormwater basin.

Apparent resistivity values above approximately 10,000 ohm-meters can generally be categorized as possible "air-filled" karst anomalies. These values can also be associated with "massive" bedrock, or extremely fractured bedrock. Zones depicting bedrock, then decreasing below resistivities of 100 ohm-meters may represent clay or soil-infilled anomalies.

To further investigate and confirm ERI survey results, ANS Geo completed a Geotechnical Investigation Program between May 2022 and September 2022 consisting of 12 test borings and ten percussion probes. The detailed summary of the findings is included in Section 3.2 and 3.3.

## 2 Introduction

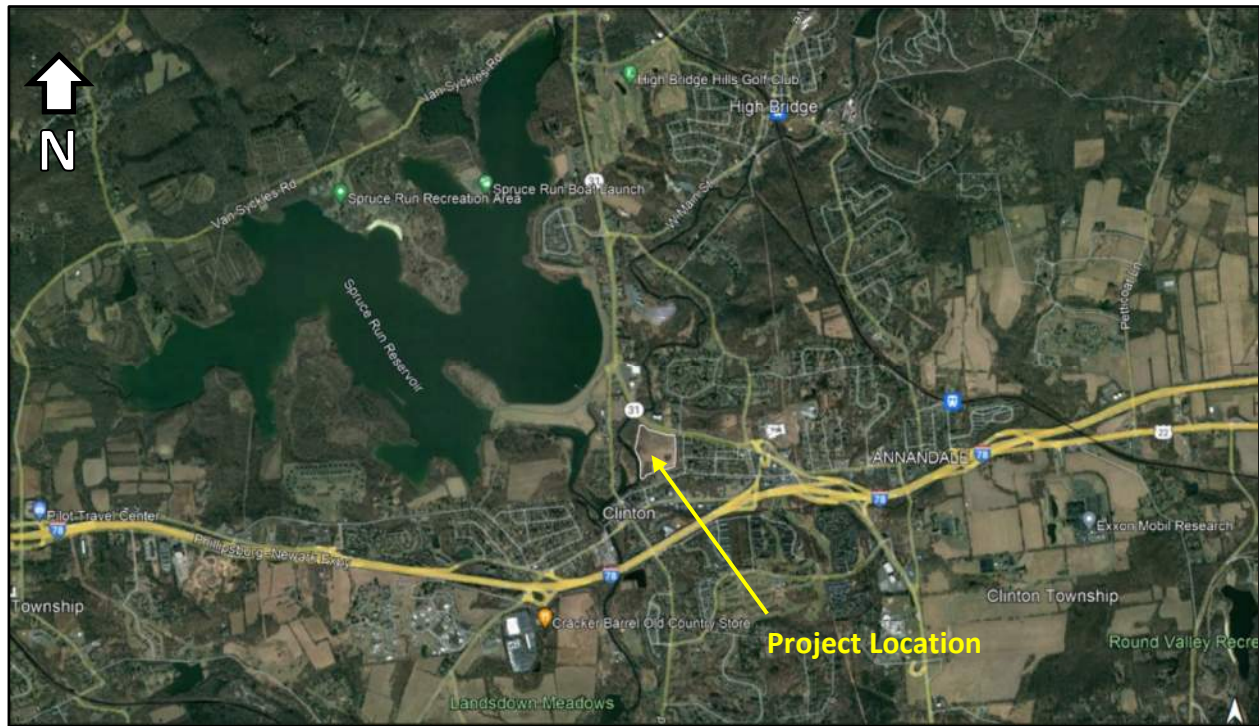
ANS Geo was retained by Concept Engineering Consultants to assist with Phase II investigation program as requested by Engineer for Town of Clinton. The Town Engineer's request included the following:

- Borings shall include 10-foot rock cores as described in the Ordinance to properly assess the condition of the underlying site bedrock.
- All identified sinkhole locations shall be investigated, since all eight (8) of potential areas are either within the footprints of the proposed structures or within proximity of the proposed stormwater basin.
- The northeast corner of the proposed Food Market where two (2) USGS mapped fracture traces and a fault intersect will require further assessment.
- The plan proposes several deep cuts (18 ft. +/-) for sewer utility installation near the proposed northern site entrance. The soil and bedrock conditions along those alignments need to be investigated to assess the potential impact of the installation.
- A major area of concern is near the single SWM Recharge Basin that is proposed for this project. The Phase I study identified possible sinkholes on three (3) sides of the proposed stormwater basin and as such, the bedrock condition underlying the proposed stormwater basin requires a thorough investigation to assess any potential impacts. This area is of high concern given its proximity to residential structures and lack of any explorations into the bedrock. Consideration must be given to the fact that more than one SWM Basin may be required (ref: G-3) to meet the Highlands requirements.

To be cost efficient, ANS Geo proposed completing non-invasive geophysical investigation to evaluate karst conditions at the proposed Clinton Commons project site in the Town of Clinton, New Jersey prior to performing test borings and/or test pits at specific locations. As part of our initial review process prior to mobilizing on the project site, ANS Geo reviewed geotechnical reports from previous investigations on the project, which identified certain areas prone to the potential for karst features such as sinkholes and faults within the project boundary.

ANS Geo placed Electrical Resistivity Imaging (ERI) locations at localized locations within the project site to obtain a specified set of data which was used to characterize the type, depth, and extent of karst features at select representative locations across the site. It should be noted the purpose of the geophysical program was not intended to be an exhaustive evaluation of the entirety of the site, as that intent would require extensive and comprehensive canvassing and investigation across the entirety of the project site. However, the investigation was intended to gain a general understanding of the subsurface conditions near locations identified in previous investigations by others and requested by the Town Engineer to gauge the impact which karst geohazards may or may not contribute to the design, siting, and construction of the proposed project. **Figure 1** below depicts a project vicinity map.

**Figure 1: Project Vicinity Map**



(Source: Google Earth Imagery 2021)

### 3 Field Investigation

#### 3.1 Electrical Resistivity Imaging (ERI)

ANS Geo completed ERI survey at the project site on February 28<sup>th</sup> and March 1<sup>st</sup>, 2022. A Geophysics Investigation Location Plan, which shows the location of all geophysical survey transects (lines) as they correspond to the proposed site development layout is provided as **Appendix A**. ERI survey methods used for this field investigation were a combination of Dipole-Dipole and Strong Gradient. The methods were completed using an array of electrodes positioned in a linear fashion along the proposed survey locations. In total, nine (9) ERI survey transects were completed within the project area. **Appendix B** includes **Figures 1** through **6**, which represent each of the nine surveyed locations with an associated profile. ANS Geo’s ERI surveys were cross-referenced against previous test boring data completed by Engineering and Land Planning Associates. **Table 1** summarizes the geophysical survey method and ID number, reporting Figure number, distance, and orientation of each line, as well as their spacing distances used for ERI testing.

**Table 1 – Geophysical Survey Parameters**

Method-ID	Figure No.	Profile Orientation	Survey Distance (ft)	Electrode Configuration/Qty	Electrode Spacing (ft)
ERI-1	1	North to south	270	28	10
ERI-2	1	Northwest to southeast	270	28	10
ERI-3	2	Northwest to southeast	270	28	10
ERI-4	3	Northwest to southeast	270	28	10
ERI-5	4	Northwest to southeast	270	28	10
ERI-6	4	Southwest to northeast	275	56	5
ERI-7	5	Southwest to northeast	270	28	10
ERI-8	5	West to east	560	56	10
ERI-9	6	North to south	270	28	10

### 3.2 Percussion Probes

The percussion probes were completed by Hayduk Enterprises of Factoryville, Pennsylvania between May 4<sup>th</sup> and May 10<sup>th</sup>, 2022. Percussion probes were advanced using ECM-590 Self-Contained Hydraulic Crawler Drill, which uses a drilling hammer with compressed air and a down-the-hole hammer with drilling bit that is advanced by this hammering and rotation action. All percussion probes were advanced a depth of 49 feet BGS and estimated top of rock is based on drilling timing is provided in **Table 2** below.

**Table 2 – Percussion Probe**

Percussion Probe ID	Estimated Top of Rock (feet)	Completed Depth (feet)
PP-01	7	49
PP-02	7	49
PP-03	7	49
PP-04	4	49
PP-05	24	49
PP-06	7	49
PP-07	12	49
PP-08	18	49
PP-09	6	49
PP-10	5	49

Sudden drops of drilling rod, which is a typical indication of karst features such as air-void or soil-filled void were not encountered in all completed percussions probes. The ERI survey results from ERI-5, ERI-6, ERI-8, and ERI-9 indicated overburden soil to be thicker than other ERI survey locations. This was confirmed by percussion probes PP-05, PP-07 and PP-08, where the overburden soil was encountered as deep as 24 feet BGS, 12 feet BGS, and 18 feet BGS, respectively. All percussion probes were backfilled as per NJDEP well abandonment requirements. Investigation Location Plan and percussion probe logs are provided in **Appendix C and Appendix D**, respectively.

### 3.3 Test Borings

ANS Geo retained Boring Brothers, Inc. of Egg Harbor, New Jersey to advance the test borings. The first mobilization of test borings was completed between May 11<sup>th</sup> and May 13<sup>th</sup>, 2022, and the second mobilization of test boring were completed between September 12<sup>th</sup> and September 20<sup>th</sup>, 2022 using a CME-55LC track-mounted drill rig with a 3-7/8-inch diameter tri-cone roller bit mud-rotary techniques to the proposed borehole termination depth or top of rock. Once estimated bedrock was encountered, minimum 10 feet of rock coring was performed in accordance with Town of Clinton's Chapter 88 Land Use Article VII Zoning Regulations 88-64.2 Carbonate Area District requirements. Soil samples were collected using the Standard Penetration Test (SPT) Method in accordance with American Society for Testing Materials (ASTM) Standard D1586 – Standard Test Method for SPT and Split-Barrel Sampling of soils. Rock coring was completed using ASTM D2113-08 – Standard Practice for Rock Core Drilling. All boreholes were backfilled as per NJDEP well abandonment requirements. It should be noted that NJDEP requested that test borings shall not be performed within 1,000 feet of existing bald eagle's nest once ANS Geo's test boring crew mobilized on site in May 2022. Therefore, only six test borings were completed in the previous report submitted by ANS Geo. As of this report, remaining six test Borings were completed in September 2022. This report comprises of all the Borings which is summarized in **Table 3** below.



**Table 3 – Test Borings**

Borehole ID	Approx. Existing Elevation (feet)	Approx. Proposed Elevation (feet)	Approx. Elevation Difference (feet)	Proposed Boring Depth (feet)	Encountered Top of Rock (feet)	Total Depth of Rock Coring (feet)	Borehole Termination Depth (feet)
B-01	235	241	-6	40	17	10	27
B-02	234	241	-7	40	Borehole Removed from Scope of Work		
B-03	253	256	-3	40	20	10	30
B-04	222	224	-2	40	23	10	33
B-05	246	246	0	40	4	10	14
B-06	269	264	5	40	10	30	40
B-07	245	244	1	40	5	10	15
B-08	264	263	1	40	10	10	20
B-09	249	242	7	40	3	10	13
B-10	258	256	2	40	10	10	20
B-11	222	224	-2	40	Borehole Removed from Scope of Work		
B-12	260	261	-1	40	10	10	20
B-13	235	225	10	40	10	10	20
B-14	245	251	6	40	Borehole Removed from Scope of Work		
B-15	253	252	1	40	4	10	14

### 3.3.1 Encountered Subsurface Conditions in Test Borings

Total 12 of 15 proposed test borings were completed in this report. Three borings were removed from our scope of work due to sufficient test borings and percussion probes. As completed boring locations are included in the Investigation Location Plan in **Appendix C**. The overburden material encountered consisted of sand and clay underlain by gravel stratum before encountering bedrock. Average N-values ranged from 6 to 15 blows per foot (bpf) within the sand and clay stratum, and greater than 50 bpf within the gravel stratum. Groundwater was not encountered within the overburden soil.

Top of bedrock within the completed twelve test borings ranged from 4 to 23 feet BGS. Recovered rock cores were classified as Limestone moderately weathered, weak to medium strong rock, and very close to close discontinuities spacing. Rock core recovery ranged from 13% to 100% and Rock Quality Designation (RQD) ranged from 0% to 97%. Fractured rock zones were generally encountered within the low RQD zones.

Based on ERI-4 survey results, potential karst anomaly may exist between 25 to 37 feet BGS on the southern end of the ERI survey. Therefore, test boring B-06 was advanced to minimum 40 feet BGS at the location to determine if karst features such as soil infilled or air-void will be encountered. In test boring B-06, top of bedrock was encountered at 10 feet BGS and 30 feet of bedrock was cored. Rock core recoveries ranged from 98% to 100% and RQDs ranged from 45% to 97%. Fractured rock was encountered between 31.3 to 34.4 feet BGS, but loss of drilling water, drill rod drops, or residual soil zones were not encountered within test boring B-06, which are typical indications of karst anomalies. In addition, ANS Geo attempted use a borehole camera to confirm any anomalies, but water in the open borehole prevented recording any clear images of cored borehole. For additional details, refer to **Appendix E** for test boring logs and rock core photos.

## 4 Geophysical Investigation Method

### 4.1 Electrical Resistivity Imaging (ERI)

ERI is a geophysical survey method that measures electrical resistivity in soil and rock based off the principles of Ohm's Law. Data obtained through an ERI investigation acquires a series of voltage and current measurements from surface electrode arrays. The electrode arrays consist of a series of dipoles that communicate with other dipoles. The arrays can be spaced close or very far apart depending on necessary survey resolution. Resistivity is dependent on the material property and geometry and thus is measured in Ohm-meters.

#### 4.1.1 Theory

Electrical resistance is based upon Ohm's Law:

$$R = \frac{V}{I} \text{ [ohms]}$$

Where, resistance, **R**, is equal to the ratio of potential, **V** (volts) to current flow, **I** (amperes).

Resistivity is the measure of the resistance along a linear distance of a material with a known cross-sectional area. Consequently, resistivity is measured in Ohm-meters. This Report presents the geophysical results as geo-electrical profiles of modeled resistance plotted as two-dimensional profiles of distance and depth, in units of feet.

Electrical currents propagate as a function of three material properties: (1) ohmic conductivity, (2) electrolytic conductivity, and (3) dielectric conductivity. Ohmic conductivity is a property exhibited by metals. Electrolytic conductivity is a function of the concentration of total dissolved solids and chlorides in the groundwater that exists in the pore spaces of a material. Dielectric conductivity is a function of the permittivity of the matrix of the material. Therefore, the matrix of most soil and bedrock is highly resistive. Of these three properties, electrolytic conductivity is the dominant material characteristic that influences the apparent resistivity values collected by this method. In general, resistivity values decrease in water-bearing rocks and soil with increasing:

- a. Fractional volume of the rock occupied by groundwater;
- b. Total dissolved solid and chloride content of the groundwater;
- c. Permeability of the pore spaces; and,
- d. Temperature.

Materials with minimal primary pore space (i.e., limestone, dolomite) or those which lack groundwater in the pore spaces will exhibit high resistivity values (Mooney, 1980). Factors contributing to low resistivity:

- Degree of water bearing void space within soil and rock (only if water exists);
- Chloride content of water bearing within soil and rock pore space;
- Available pore space within material (i.e., low pore space will decrease resistivity);
- Temperature.

Highly porous, moist, or saturated soil will exhibit very low resistivity values. Additionally, high resistivity values will result from generally inverse conditions (i.e., highly-porous and dry conditions). This is, of course, a range, and most earthen materials falls within the range of low to medium resistivity depending on their properties. For these reasons, cavities, voids, highly fractured bedrock and groundwater can often have definable values observed through the methods of ERI.

In homogeneous ground, the apparent resistivity is the true ground resistivity; however, in heterogeneous ground, the apparent resistivity represents a weighted average of all formations through which the current passes.

### 4.1.2 Methods

Different acquisition algorithms can be implemented during an investigation. For this investigation, the Dipole-Dipole / Strong-Gradient array combination methods, which have proven to be an effective configuration for imaging voids in shallow bedrock settings, were implemented. The measurements were collected to create a two-dimensional image. The image is developed using an inversion algorithm. The inversion algorithm uses the collected apparent resistivity data to create a model space of resistivity values that would replicate the collected data.

While homogeneous ground conditions represent the true apparent ground resistivity, non-unique values represent a weighted average of the multiple formation variations (Reynolds, 1997). Apparent resistivity values are computed with a forward modelling subroutine, and a smoothness-constrained least-squares optimization routine, creating a pseudosection using finite-difference or finite-element approaches. The pseudosection model is compared to the actual measurements for consistency. A measure of the inversion progress and difference is given by the root-mean-squared error.

### 4.1.3 Data Collection and Data Processing

Six total ERI profiles were acquired using an AGI SuperSting R8 Resistivity meter. Seven (7) of the ERI surveys were completed with a 28-electrode setup at 10-foot spacings. One (1) ERI profile was acquired in conjunction with a 56-electrode setup at 5-foot spacings and another at 10-foot spacings. Measurements were obtained through a combined Dipole-Dipole and Strong Gradient paired array setup. Locational data were recorded using a Trimble Geo7X global positioning system. The approximate depth of penetration of the survey is contingent on a few factors, most of which relate to the overall survey line length. Each test reached an approximate penetration depth of 60 feet below existing grade. Two-dimensional profiles have been provided within **Appendix B**.

## 5 Background Geology

Prior to site mobilization, ANS Geo reviewed geologic mapping made publicly available by the United States Geologic Survey (USGS), which indicates the site is underlain by Allentown Dolomite and the Lower Beekmantown Group. These groups both generally consist of light gray to medium-gray dolomite with minor orthoquartzite and shale beds. These rock types are known for their susceptibility of karst formation which is addressed in Section 5.3.

### 5.1 Surficial Geology

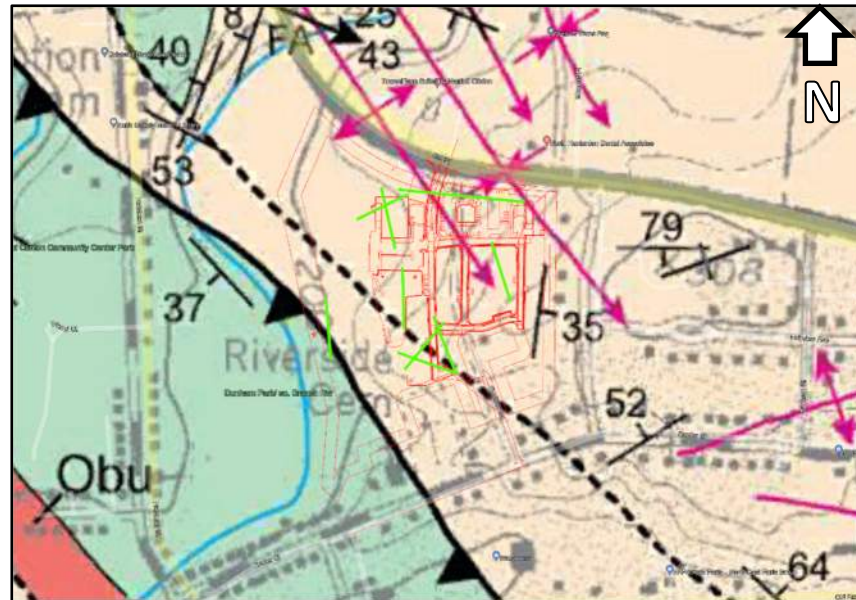
ANS Geo also conducted a desktop study of the surficial geology in the project area using the National Resource Conservation Service (NRCS) Web Soil Survey. The Web Soil Survey only evaluates the upper five feet of soils, as it is generally used for agricultural purposes. However, reviewing this information can indicate what soil properties can be expected on site. The NRCS mapping indicates that the project area consists primarily as material of the Duffield silt loam unit, which is comprised primarily of silts and clays and shallow unweathered bedrock.

### 5.2 Bedrock Geology

A desktop review of the local bedrock geology was conducted using publicly available mapping and literature published by the New Jersey Geological and Water Survey and the USGS. Based on this mapping, the predominant bedrock formation within the project boundary is the Allentown Formation consisting primarily of Dolomite. The Lower Beekmantown Group exists within the southwestern portion of

the site and also consists of Dolomite. Due to the degree of folding and fracturing of the bedrock, bedrock may generally present a high degree of dipping. Additionally, a thrust-fault was mapped within the northwest corner of the project site heading southeast. After reviewing the New Jersey Geological Society's latest (2015) *Bedrock Geologic Map of the High Bridge Quadrangle*, it appears that the previously mapped "Thrust Fault" as depicted within E&LP's Report has been updated and moved southwest of the project site. The updated mapping does place a thrust fault within the proposed developments. However, it now runs northwest to southeast along the southwest boundaries of the project site, as depicted within **Figure 2** below. In addition, Concealed Fault, Anticline, and Syncline are mapped within the project site.

**Figure 2: Updated Geologic Map**



Based on our knowledge and experience, concealed faults can be small and are difficult to identify compared to thrust faults. The "dipping" direction or dip angle is unknown compared to identified thrust faults unless bedrock is exposed above ground surface.

### 5.3 Karst Geology

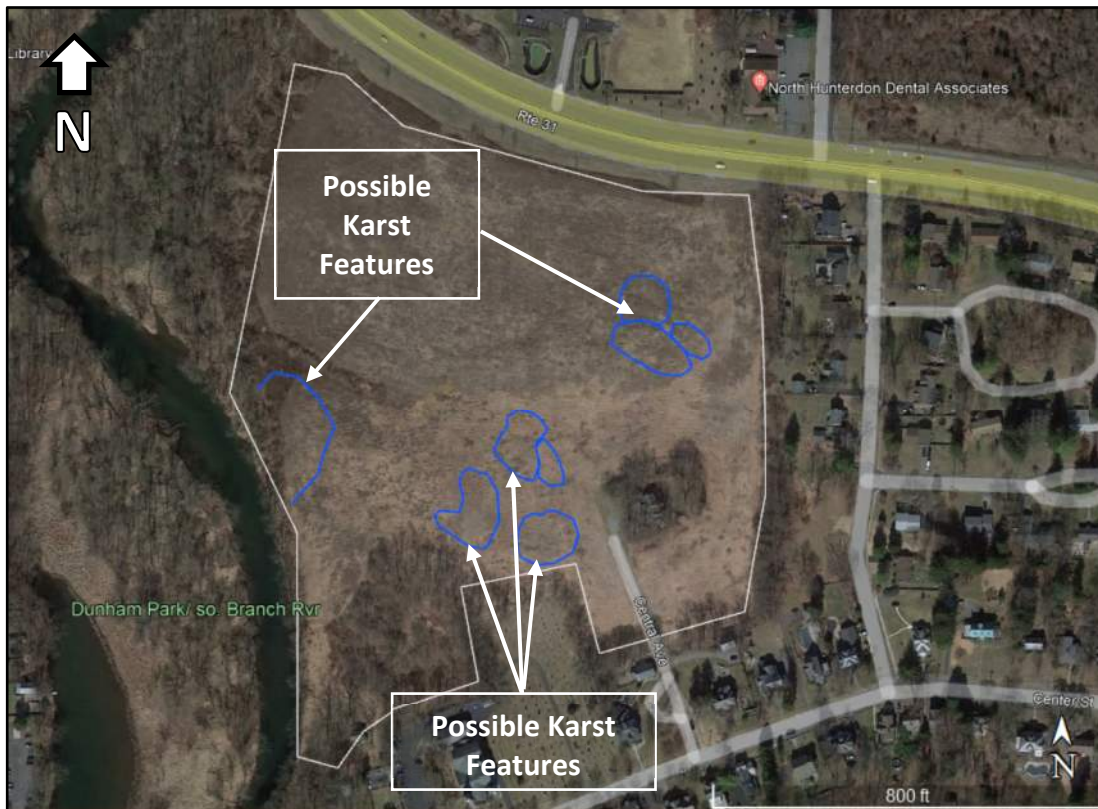
Ground subsidence, commonly referred to as "sinkholes", is the local downward movement of surface material with little or no horizontal movement. Subsidence is a potential geologic hazard in areas where karst terrain occurs, or where underground mining has taken place. In karst terrain, limestone and dolomite bedrock (carbonate rock formations) are eroded by water and create karst features such as subsurface channels, caves, and sinkholes. Within the Allentown Formation, karst can be prevalent. Due to the project site having multiple mapped fracture sets, these are areas where a higher amount of dissolution may occur as they become preferential pathways for groundwater drainage.

### 5.4 Aerial Imagery Evaluation for Previous On-Site Subsidence Events

ANS Geo conducted a review of aerial images across the site to create a map of potential subsidence events that have occurred or are currently active within the project boundaries. Potential subsidence incidences can be identified by reviewing site topography, looking at shading on the ground surface of aerial images, surface water drainage pathways, and looking for pooling or standing water. No identifiable subsidence occurrence within the project boundaries could be confirmed visually via aerial imagery. Through review of Engineering & Land Planning Associates 2020 "*Karstic Geology Investigation Report*", USGS NAPP color infra-red (CIR) imagery was evaluated, and eight (8) possible karstic locations were delineated based off of that imagery. Those locations are depicted in **Figure 3**.



Figure 3 – Potential On-Site Subsidence Incidents



(Source: Google Earth 2021 Imagery)

## 6 Geophysical Analysis

Limestone and Dolomite that matures within karstic or dissolution prone conditions undergoes a variable maturation process. When younger, the features represent small caves, short caves, and uniform rockhead. As the karst matures, so does its complexity. Cover-subsidence and cover-collapse sinkholes, irregular or pinnacled rockhead, buried sinkholes, all become more prevalent. The surveys conducted showed variability in the presence, depth, and characteristics of karst features across the site; however, they were also consistent on multiple fronts.

### 6.1 Electrical Resistivity Imaging Analysis

The depth to interpreted bedrock ranged from approximately at existing grade to 10 feet below existing grade with the results of the ERI surveys and previous completed soil borings correlating well (showing similar depths). ANS Geo's planned geotechnical investigation will provide more data from test borings and/or test pits to correlate and confirm ERI results.

Top of bedrock was observed to generally fluctuate along the ERI profiles. This is indicative of "pinnacled" top of bedrock and usually occurs over extended dissolution and weathering of the bedrock surface. As expected, our surveys indicate that the quality of the bedrock generally gets better with increased depth. There were indications of past dissolution, collapse and soil-infilling within a six of the ERI surveys completed. As these zones are soil-infilled and have already disintegrated, it is in our opinion that they will not provide a large risk to the project's development.

ERI methods provide indications of overall stratigraphy type and change, possible anomalies such as voids or caverns, and water bearing zones. Apparent resistivity values obtained through the ERI surveys



portrayed variable subsurface conditions with apparent resistivities ranging from less than 1 ohm-meters to over 13,000 ohm-meters. The subsurface profiles generally exhibited a moist lower resistivity clay and silt layer within the upper approximately 5 to 10 feet below grade which then varied in material type between decomposed dolomite and zones of variable resistivities within the upper approximately 5 to 30 feet below grade. A zone of very high (>10,000 ohm-m) resistivity within the upper 12 to 327 feet below existing grade existed within ERI-4. Competent bedrock was generally observed with increasing depth.

## 6.2 Geology Analysis

A top layer of clay with frequent areas of gravel inclusion was generally observed within the five to 30 feet below existing grade. Where subsidence has occurred, these soils can be very loose, indicating raveling of soils (into previously-formed voids) with one moderate sized possible open void. Particular trends were observed within the ERI data showing that portions of profiles may have experienced some degree of “raveling”. These zones will typically exhibit lower bearing strengths as the soils have experienced loosening due to possible subsidence in the past. This upper soil transitioned into a weathered dolomite that has predominantly weathered to clay, silt and gravel with sections of intact rock. This zone of weathered bedrock extended to variable depths and had transitions to pinnaced top of rock with abrupt change.

No indications of surface depressions were visible at the time of our ERI surveys.

## 7 Risk Evaluation and Conclusions

ANS Geo understands that the project site is intended to support commercial development, which will consist of residential buildings and commercial buildings such as retail stores, food market store, gas station and convenience store. In addition, new development supporting systems such as stormwater recharge basin, water lines, gas line, and stormwater and sewer lines are proposed to be constructed. To aid in site planning and development, it is important to identify the relative potential for risk across certain portions of the site to help minimize the potential for siting critical project components and structures (i.e. building foundations) within these areas with higher geologic risk of settlement and movement.

Through our investigation, it does not appear that significant representations of sinkholes or air-filled karst appear within the ERI survey data. However, karst features such as pinnaced top of bedrock, and areas of potential sinking and infilling were observed. Percussion probes and test borings were completed at select locations to confirm the presence or lack thereof karst features depicted within the geophysics results. The follow-up investigation consisting of percussion probes and test borings did not indicate that any of these features exist. Typically, if a feature exists, while drilling, drilling water loss or a sudden drop of drilling rods or soft zones would be encountered. Drilling water loss, rod drops, and soft zones were not encountered in the completed percussion probes and test borings. Additionally, the previously mapped fault locations, depicted within ERI-5 and ERI-6 were looked at closer during the geotechnical subsurface investigation consisting of a percussion probe along the two geophysical surveyed lines. The probe did not indicate any rod drops or clear indications of subsurface variation. Due to this location's proximity to a nearby bald eagle's nest and as per NJDEP's request, no test borings within confirmatory rock core were completed at time of this report.

Through our preliminary evaluation of geophysics survey results, it is in our opinion that there are karstic features onsite; however, they appear to be relic and soil-infilled features. These karstic conditions should be considered while designing foundations for the proposed developments and planning for the stormwater basin. **Table 4** provides a summary of the inferred depth to bedrock, as well as subsurface profile, evaluated as part of our geophysical investigation.

**Table 4 – Geophysics Survey Notes**

Geophysics ID	Topographic & Geologic Setting	Inferred Approximate Depth to Top of Bedrock [feet]	Notes
ERI-1	Mild sloping	~ 0' ~ 20'	Clay/Silt overburden layer with possible inclusions of gravel and sand generally 0 to 20 feet thick. Bedrock abruptly changes with depth "pinnaced". Bedrock quality is variable across the survey's length and depth.
ERI-2	Moderate sloping	~ 3' – 10'	Shallow bedrock that abruptly changes in depth.
ERI-3	Moderate sloping	~ 5' – 10'	Pinnaced top of bedrock. Generally shallow competent rock. A possible dissolution and weathered rock zone exists at approximately 190 to 270 feet horizontal distance along the ERI line.
ERI-4	Moderate sloping	~ 0' – 10'	Discontinuous overburden soils with shallow bedrock. The bedrock is highly pinnaced.
ERI-5	Mild sloping	~ 3' – 25'	Bedrock dips steeply from the northwest to southeast. Fine-grained material present as overburden soil. A possible discontinuous zone of gravel or floating bedrock exists between 3 to 25 feet. The bedrock appears to dip northwest to southeast at an approximate depth of 20 to 40 feet along the ERI line. No indications of a fault were represented within the data or follow-up percussion probe completed.
ERI-6	Mild sloping	~ 3' – 20'	Overburden soils appear to be "epi-karst" with remnants of fine-grained soils as well as granular soil and floating bedrock. Competent bedrock appears at an approximate depth of 20 to 30 feet below grade.
ERI-7	Moderate sloping	~ 0' – 10'	Bedrock quality fluctuates along the horizontal and vertical extents of the ERI survey. A highly weathered zone exists at an approximate horizontal distance of 110 to 190 feet.
ERI-8	Mild sloping	~ 0' – 30'	There may be a deep soil horizon up to 30 feet deep. The soils would most likely be a combination of fine-grained and coarse-grained material including bedrock remnants.
ERI-9	Steep sloping	~ 3' – 25'	Abruptly changing top of bedrock. Multiple dissolution and soil-infilled zones exist across the extents of the survey line.

## 8 Limitations

ANS Geo notes that the findings and recommendations presented with this Report are based on investigation program completed by ANS Geo between February and September 2022, and our engineering judgement. Geophysical investigations are a non-invasive method of interpreting physical properties of the shallow earth using electrical, electromagnetic, or mechanical energy. This document contains geophysical interpretations of responses to induced or real-world phenomena. As such, the measured phenomenon may be impacted by variables not readily identified in the field that can result in a false-positive and/or false negative interpretations. ANS Geo makes no representations or warranties as to the accuracy of the interpretations. The extent of reliability of the survey is based on the specific areas where surveys were conducted; areas outside surveyed alignments may have variations in the conditions noted. We also understand that the current investigation is considered preliminary, and that traditional geotechnical investigations including an appropriate number of borings, and associated laboratory testing of soil material have been or will be completed prior to detailed design and construction.

## 9 References

AGI. 2017 EarthImager Program. Advanced Geosciences Inc., Austin, Texas.

DeGroot-Hedlin, C. and Constable, S., 1990, Occam's inversion to generate smooth, two-dimensional models from magnetotelluric data. *Geophysics*, V. 55, 1613-1624.

Engineering & Land Planning Associates, 2020, Karstic Geology Investigation Report

Mavko, Gary. Conceptual Overview of Rock and Fluid Factors that Impact Seismic Velocity and Impedance. Stanford Rock Physics Laboratory.

Mooney, H.M. (1980) Handbook of Engineering Geophysics: Volume 2: Electrical Resistivity, Bison Instruments, Inc.

Reynolds, J.M. (1997) An Introduction to Applied and Environmental Geophysics, John Wiley, Chichester, New York, 796 p.

Xia, J.; Miller, R. D.; Park, C. B.; Hunter J. A.; Harris, J. B.; and Ivanov, J., (2002), Comparing shearwave velocity profiles inverted from multi-channel surface wave with borehole measurements: *Soil Dynamics Earthquake Engineering*, Vol. 22, pp. 181-190.

## **APPENDIX A**

### **Geophysical Investigation Survey Location Plans**





Client:

CONCEPT ENGINEERING  
CONSULTANTS, PA

GEOPHYSICS INVESTIGATION  
LOCATION PLAN  
CLINTON COMMONS  
DEVELOPMENT

TOWN OF CLINTON, NEW JERSEY

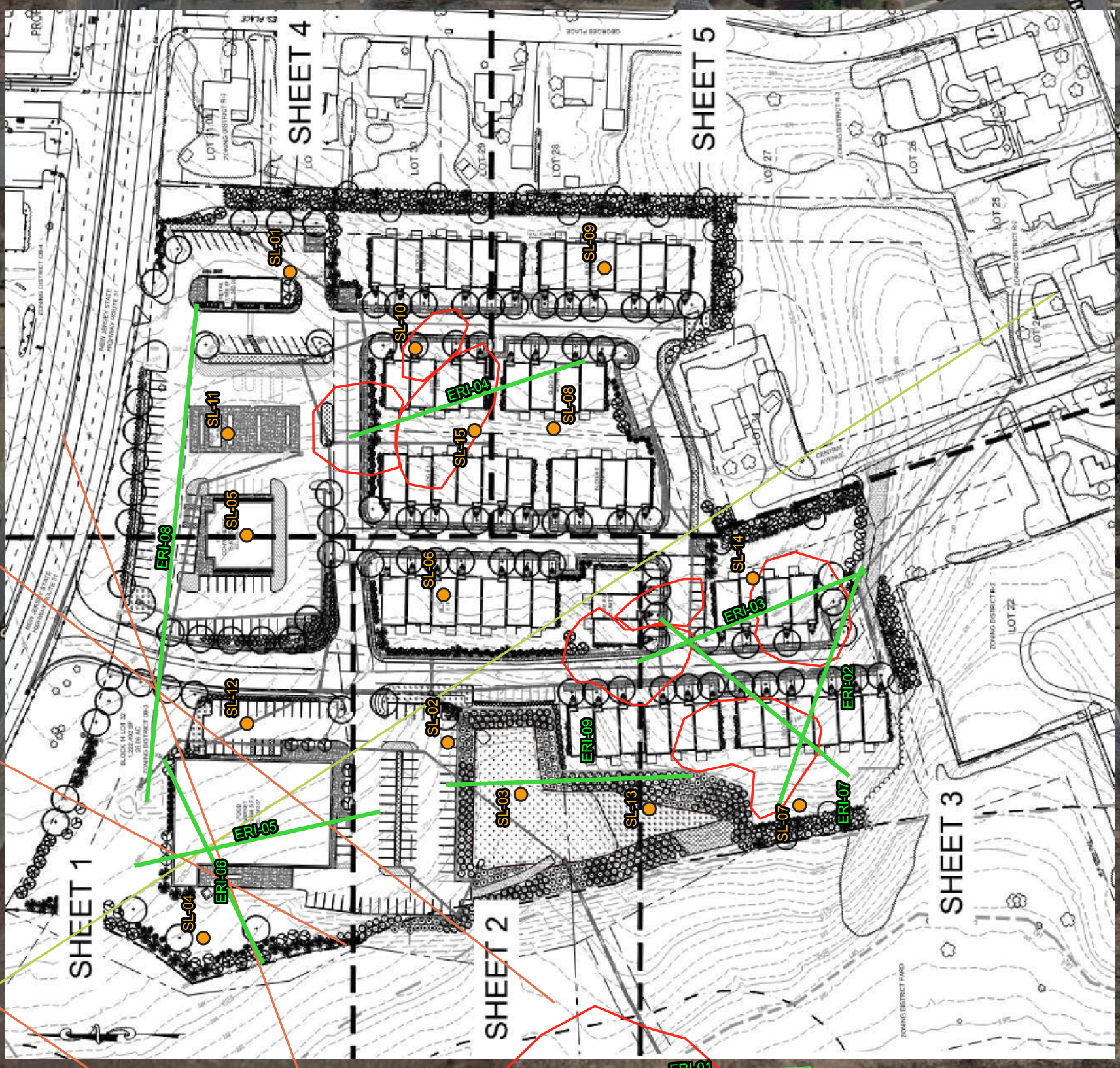
### Legend

- As-Completed E&LP Soil Borings
- As-Completed Geophysics Locations
- Possible Karst Locations
- Fractures as per E&LP's Report
- Fault as per E&LP's Report
- Project Boundary



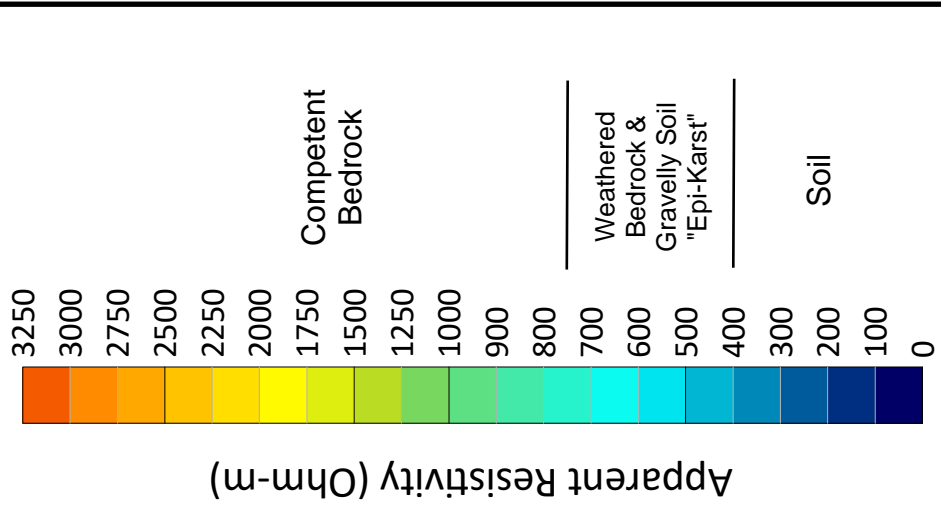
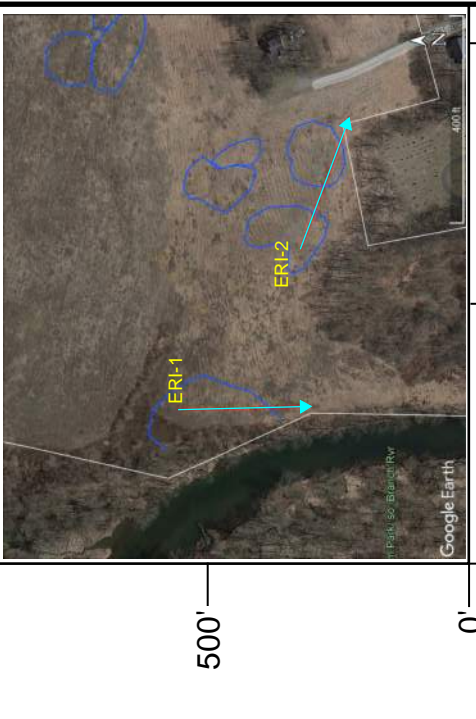
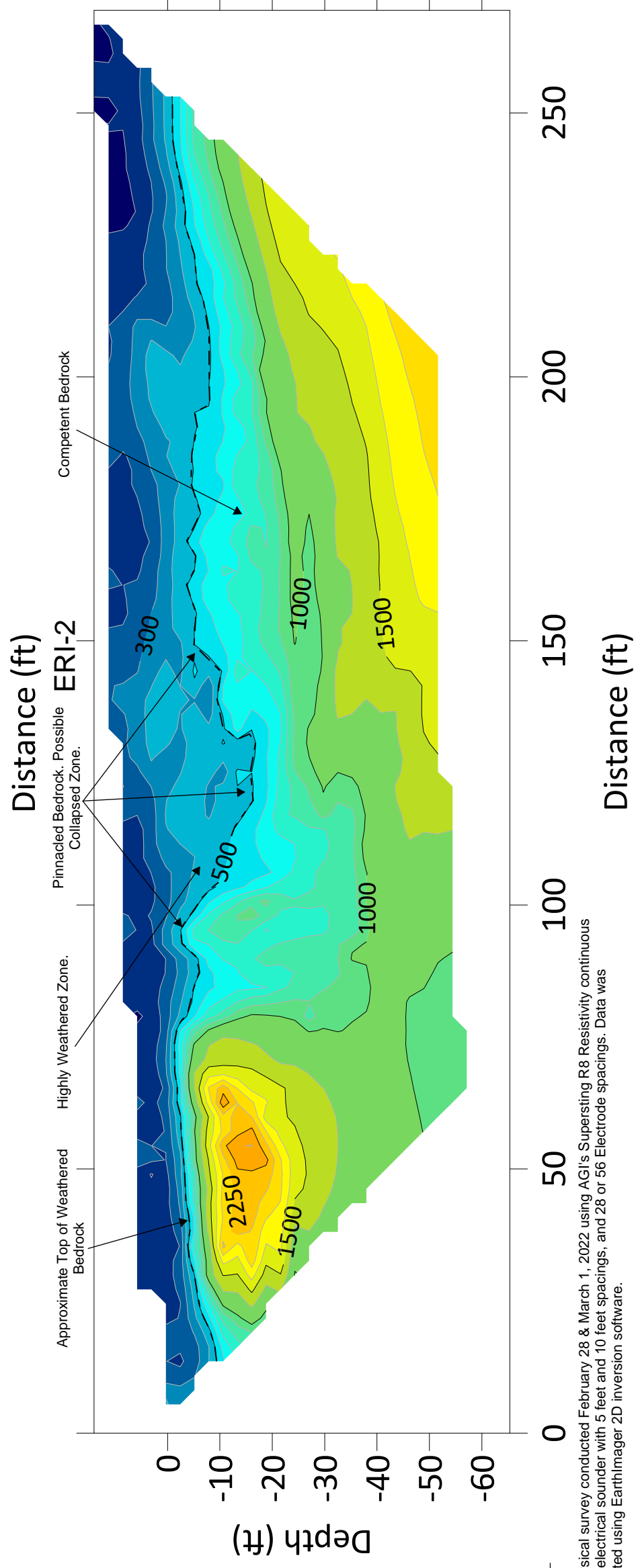
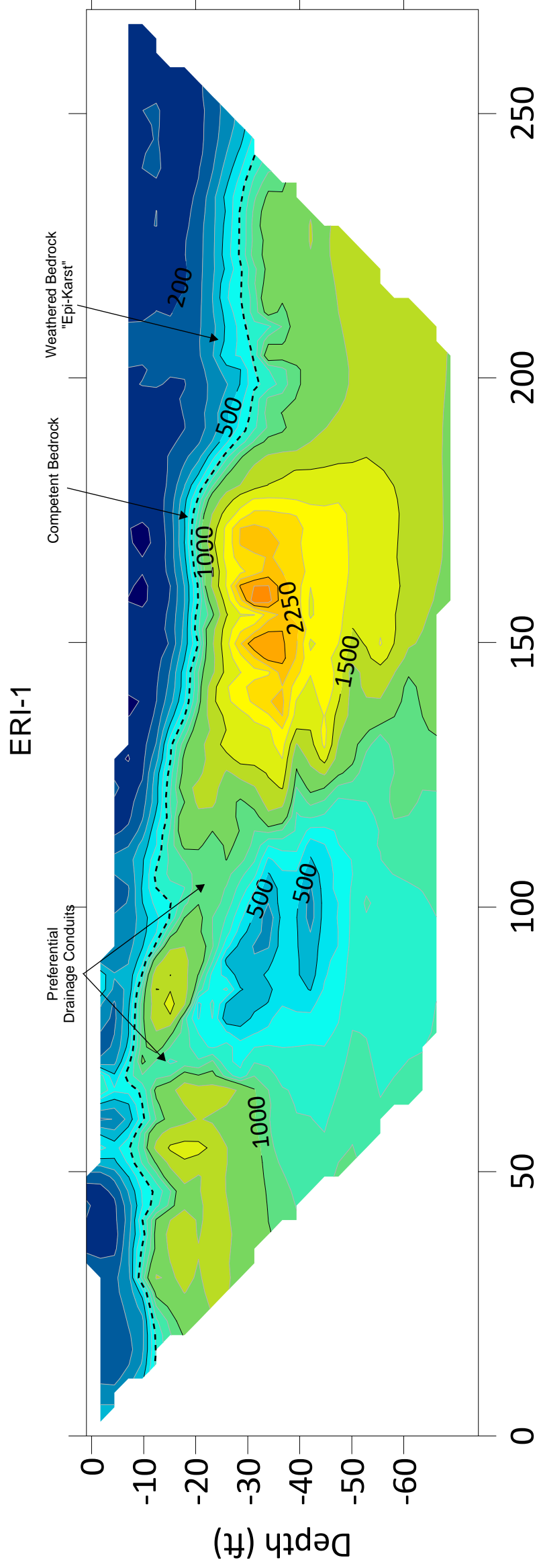
Absolute Scale: 1 inch = 150 feet  
Scale at 11" x 17" AS SHOWN

Prepared by: Jonathan Nelson  
Date: April 7, 2022  
Drawing Number: PIP-1 Rev.1





**APPENDIX B**  
**Electrical Resistivity Imaging Profiles**



<b>ANIS GEO</b>		446 S Clinton Ave Clinton, NJ 07060 (908) 754-8800 www.anisgeo.com	
DRN	JWN	3/1/2022	PROJECT:
DES	JWN	3/1/2022	Geophysical Investigation Clinton Commons Project Town of Clinton, New Jersey
CHK	TR	3/1/2022	
REV			
PROJ. MGR.	TR	3/1/2022	DRAWING NO.:
SCALE			Figure 1
SOURCE:	AGI EarthImager 2D		
PREPARED FOR:	CONCEPT ENGINEERING CONSULTANTS, PA		
			SHEET TITLE:

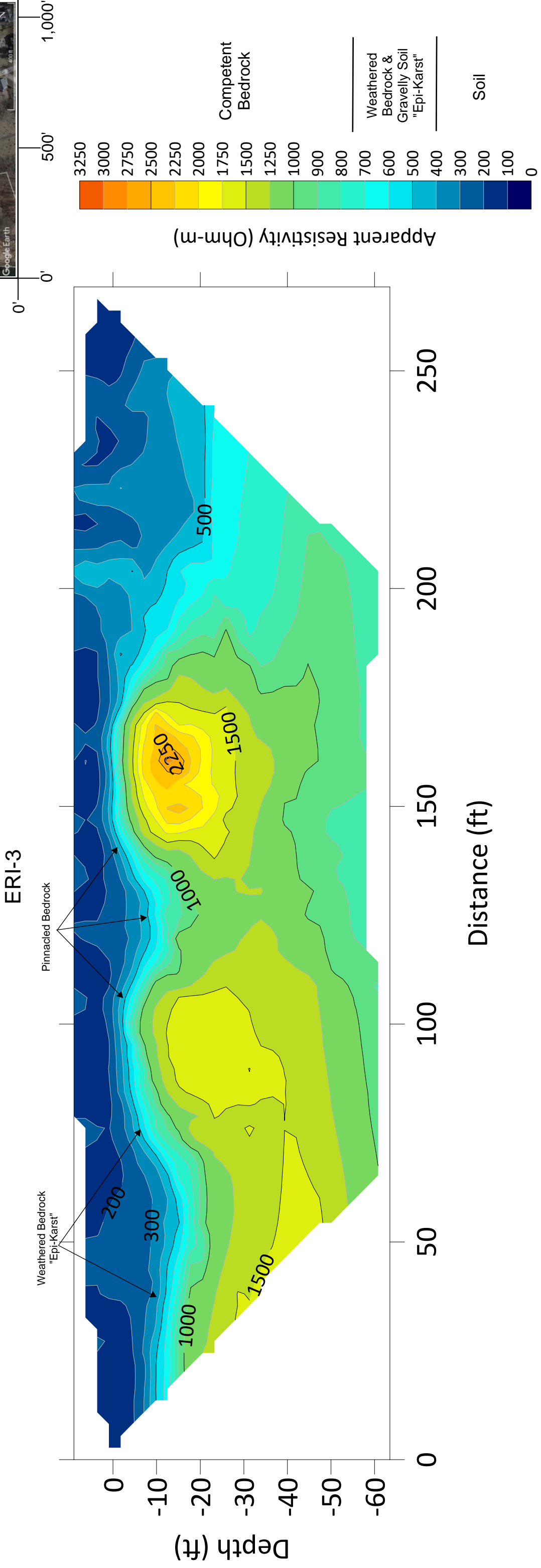
**Notes:**

Geophysical survey conducted February 28 & March 1, 2022 using AGI's Superstring R8 Resistivity continuous vertical electrical sounder with 5 feet and 10 feet spacings, and 28 or 56 Electrode spacings. Data was interpreted using EarthImager 2D inversion software.

No vertical exaggeration.

Real-time positioning of data using fully integrated Trimble Geo-7X global positioning system set to NAD 1983 New Jersey State coordinate system (US Survey feet).

Locations are approximate.



		4405 S Clinton Ave Marlton, NJ 08053 (609) 754-8800 www.ansgeo.com																
<b>PROJECT:</b>																		
<table border="1"> <tr> <td>DRN</td> <td>JWN</td> <td>3/17/2022</td> </tr> <tr> <td>DES</td> <td>JWN</td> <td>3/17/2022</td> </tr> <tr> <td>CHK</td> <td>TR</td> <td>3/18/2022</td> </tr> <tr> <td>REV</td> <td></td> <td></td> </tr> <tr> <td>PROJ. MGR.</td> <td>TR</td> <td>3/18/2022</td> </tr> </table>	DRN	JWN	3/17/2022	DES	JWN	3/17/2022	CHK	TR	3/18/2022	REV			PROJ. MGR.	TR	3/18/2022	<b>Geophysical Investigation Clinton Commons Project Town of Clinton, New Jersey</b>		
DRN	JWN	3/17/2022																
DES	JWN	3/17/2022																
CHK	TR	3/18/2022																
REV																		
PROJ. MGR.	TR	3/18/2022																
<b>DRAWING NO.:</b>																		
Figure 2 Electrical Resistivity Imaging Profile Location 3 (ERI-3)																		
<b>SOURCE:</b> AGI EarthImager 2D																		
<b>PREPARED FOR:</b>																		
<b>CONCEPT ENGINEERING CONSULTANTS, PA</b>																		
<b>PROJECT NO.:</b>																		
<b>SHEET TITLE:</b>																		

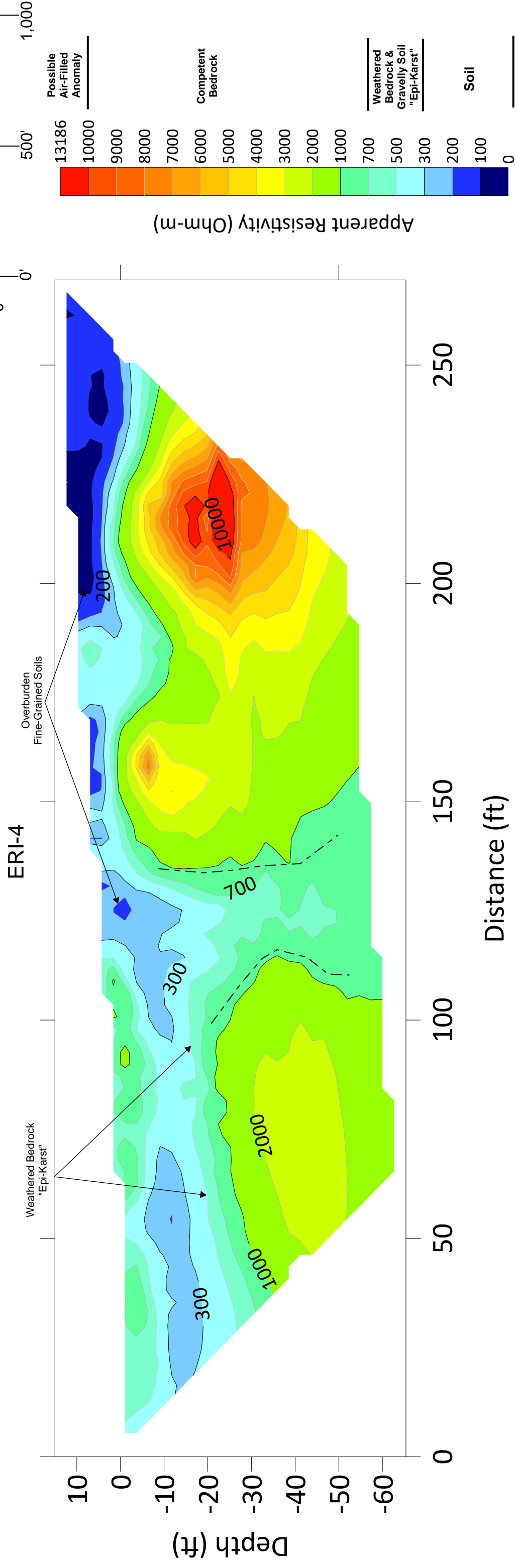
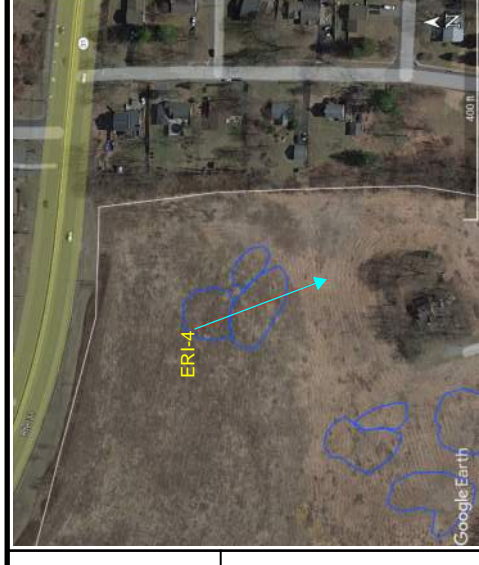
**Notes:**

Geophysical survey conducted February 28 & March 1, 2022 using AGI's Superstring R8 Resistivity continuous vertical electrical sounder with 5 feet and 10 feet spacings, and 28 or 56 Electrode spacings. Data was interpreted using EarthImager 2D inversion software.

No vertical exaggeration.

Real-time positioning of data using fully integrated Trimble Geo-7X global positioning system set to NAD 1983 New Jersey State coordinate system (US Survey feet).

Locations are approximate.



**Notes:**

Geophysical survey conducted February 28 & March 1, 2022 using AGI's Superstring R8 Resistivity continuous vertical electrical sounder with 5 feet and 10 feet spacings, and 28 or 56 Electrode spacings. Data was interpreted using EarthImager 2D inversion software.

No vertical exaggeration.

Real-time positioning of data using fully integrated Trimble Geo-7X global positioning system set to NAD 1983 New Jersey State coordinate system (US Survey feet).

Locations are approximate.

DRN	JWN	3/1/2022
DES	JWN	3/1/2022
CHK	TR	3/1/2022
REV		
PROJ. MGR.	TR	3/1/2022
SCALE		
SOURCE:	AGI EarthImager 2D	
PREPARED FOR:	CONCEPT ENGINEERING CONSULTANTS, PA	

**ANSGEO**  
 4405 S Clinton Ave  
 Marlton, NJ 08053  
 (856) 754-8800  
 www.ansgeo.com

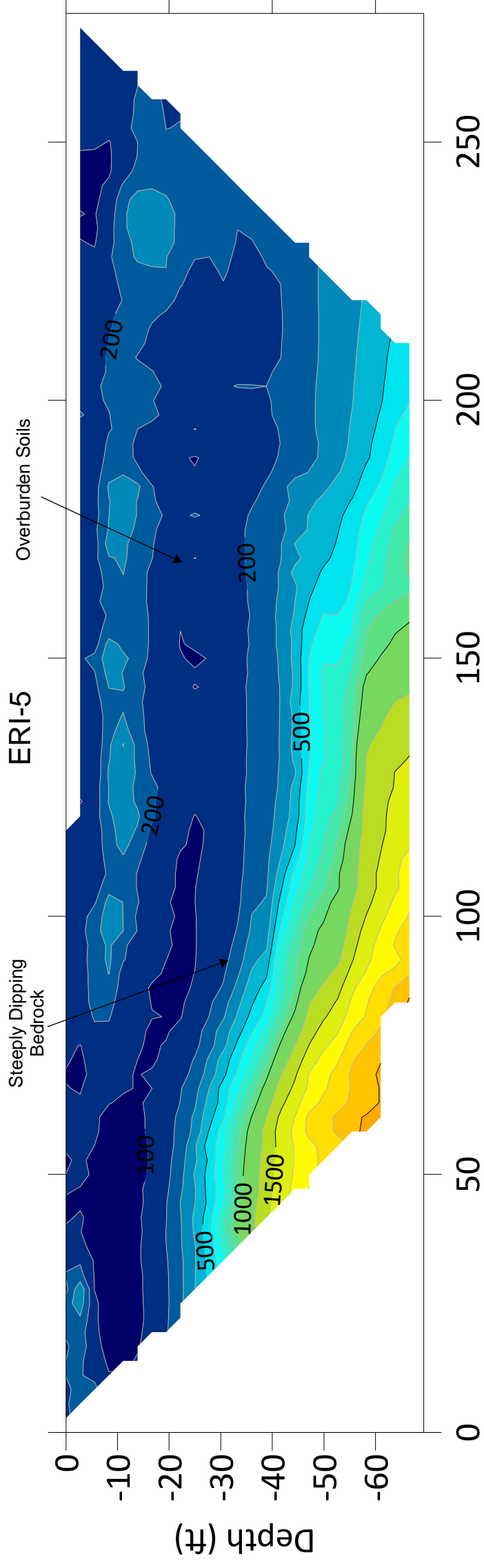
**PROJECT:**  
 Geophysical Investigation  
 Clinton Commons Project  
 Town of Clinton, New Jersey

**DRAWING NO.:**  
 Figure 3  
 Electrical Resistivity Imaging Profile  
 Location 4 (ERI-4)

**PROJECT NO.:**

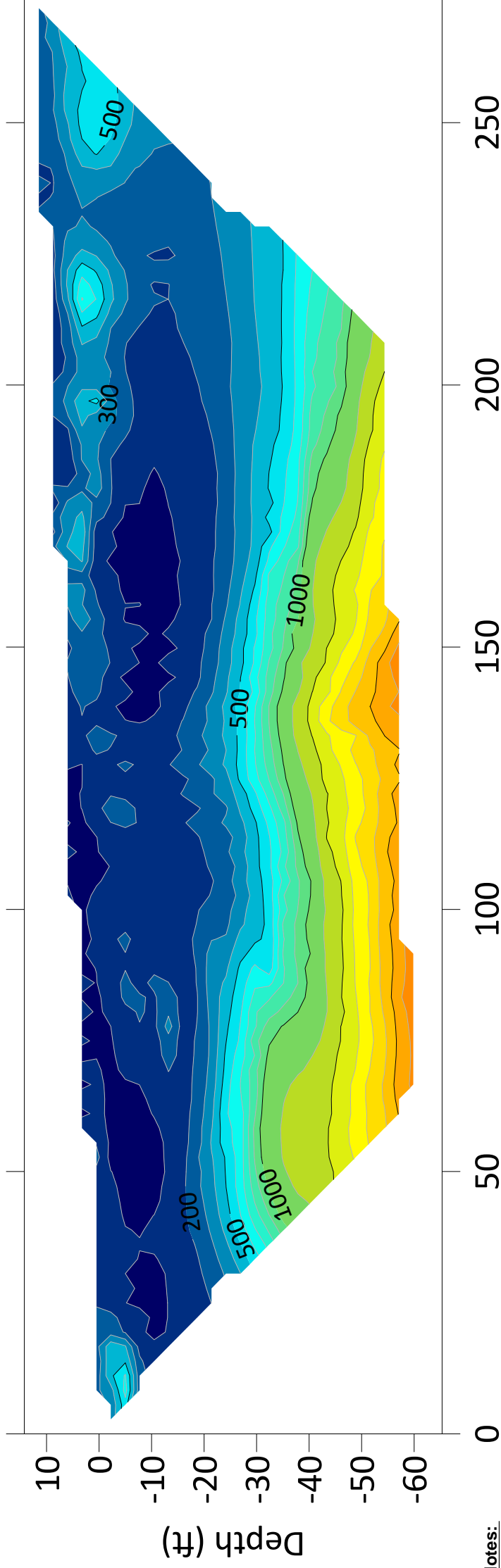
**SHEET TITLE:**





Distance (ft)

ERI-5



Depth (ft)

Notes:

Geophysical survey conducted February 28 & March 1, 2022 using AGI's Supersting R8 Resistivity continuous vertical electrical sounder with 5 feet and 10 foot spacings, and 28 or 56 Electrode spacings. Data was interpreted using EarthImager 2D inversion software.

No vertical exaggeration.

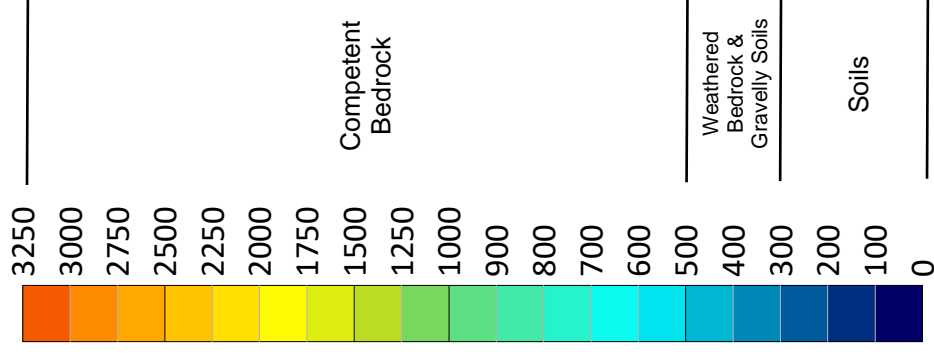
Real-time positioning of data using fully integrated Trimble Geo-7X global positioning system set to NAD 1983 New Jersey State coordinate system (US Survey feet).

Locations are approximate.



Google Earth

Apparent Resistivity (Ohm-m)



DRN	JWN	3/1/2022
DES	JWN	3/1/2022
CHK	TR	3/1/2022
REV		
PROJ. MGR.	TR	3/1/2022
SCALE		
SOURCE:	AGI EarthImager 2D	
PREPARED FOR:	CONCEPT ENGINEERING CONSULTANTS, PA	

**ANIS GEO**  
 4405 S Clinton Ave  
 Marlton, NJ 08053  
 (609) 754-8800  
 www.anisgeo.com

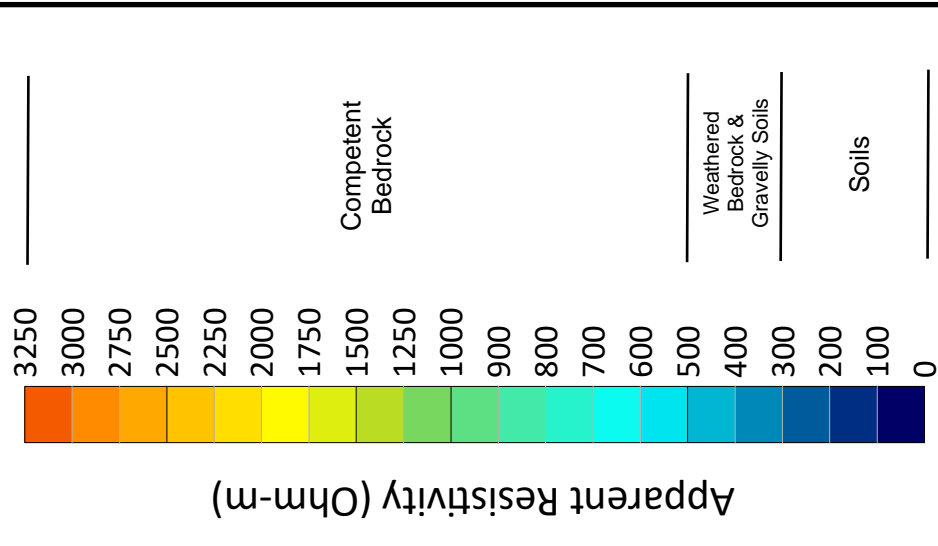
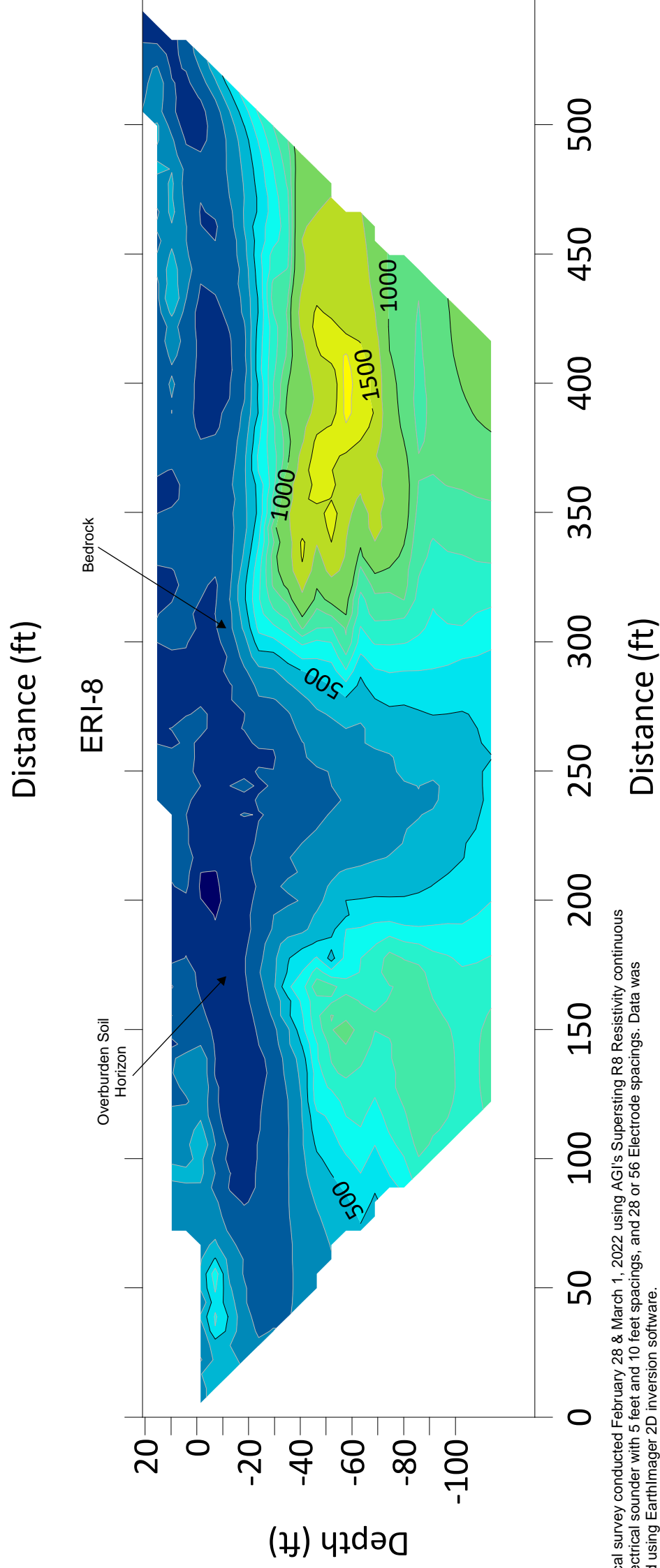
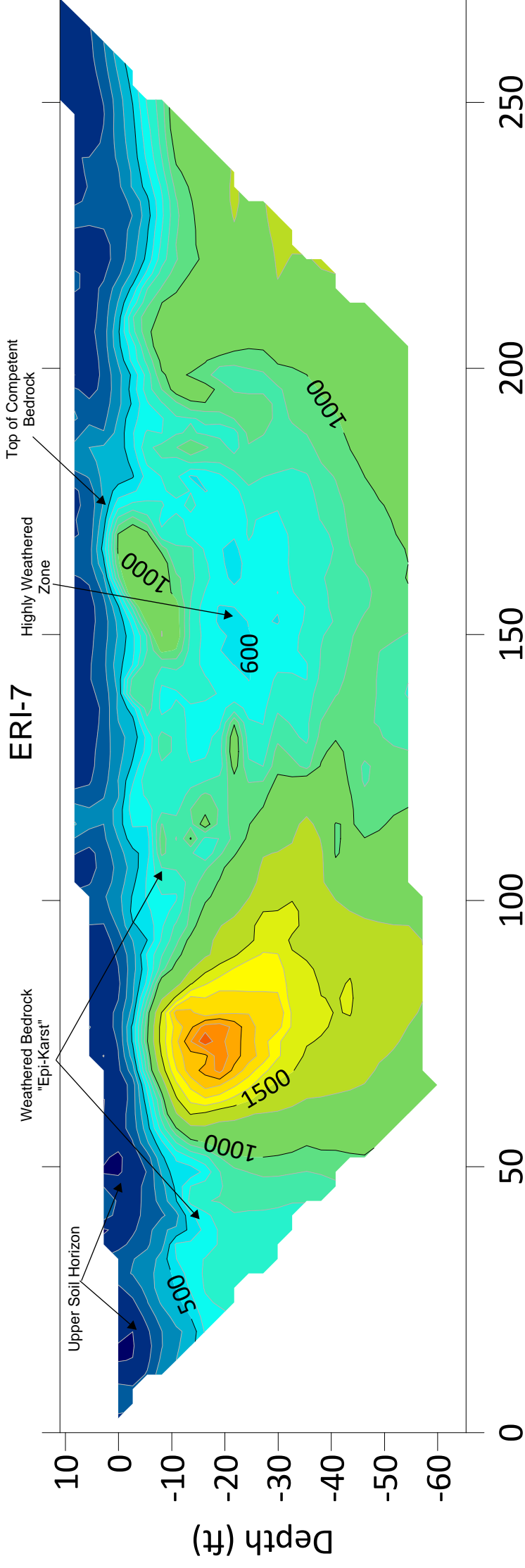
**Geophysical Investigation  
 Clinton Commons Project  
 Town of Clinton, New Jersey**

**Figure 4  
 Electrical Resistivity Imaging Profile  
 Location 5 & 6 (ERI-5 & ERI-6)**

PROJECT NO.:  
 SHEET TITLE:

CONCEPT ENGINEERING  
 CONSULTANTS, PA





Soils

Competent  
Bedrock

Weathered  
Bedrock &  
Gravelly Soils

Soils

**Notes:**

Geophysical survey conducted February 28 & March 1, 2022 using AGI's Superstring R8 Resistivity continuous vertical electrical sounder with 5 feet and 10 feet spacings, and 28 or 56 Electrode spacings. Data was interpreted using EarthImager 2D inversion software.

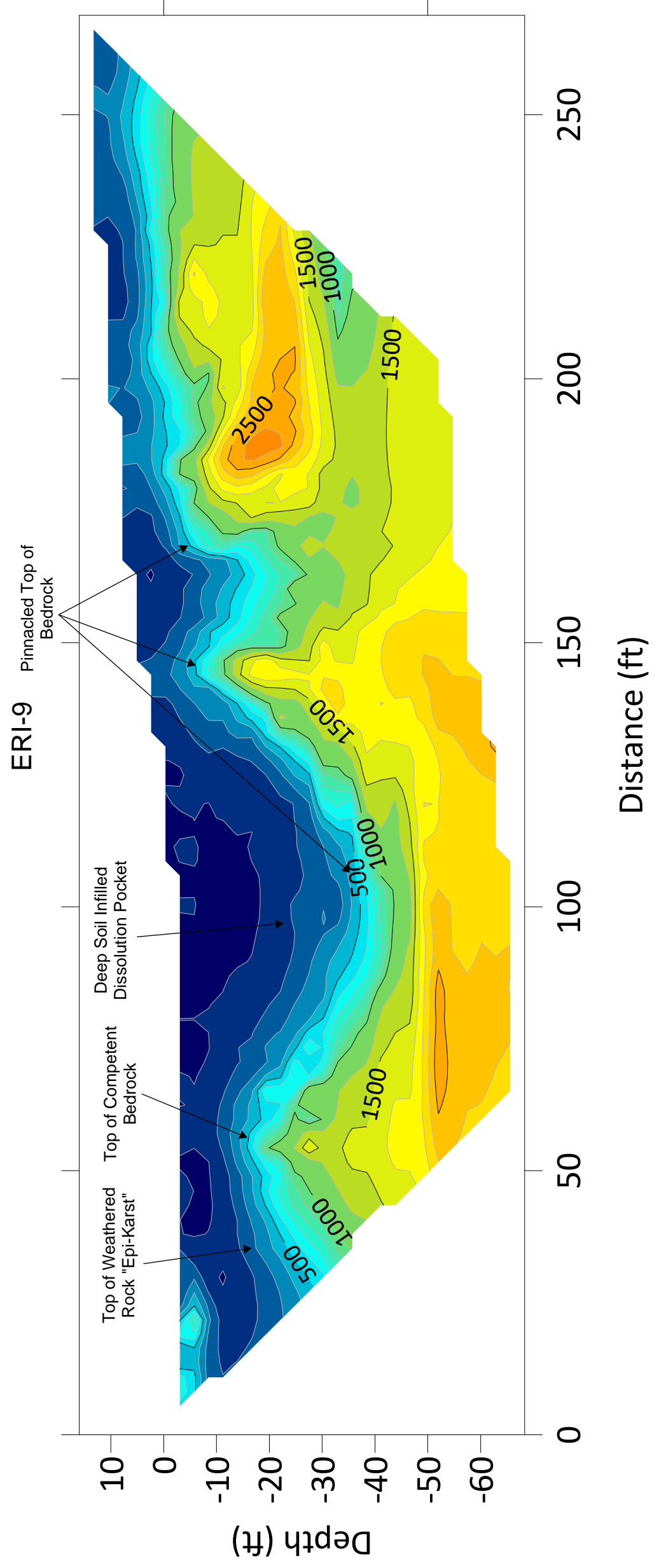
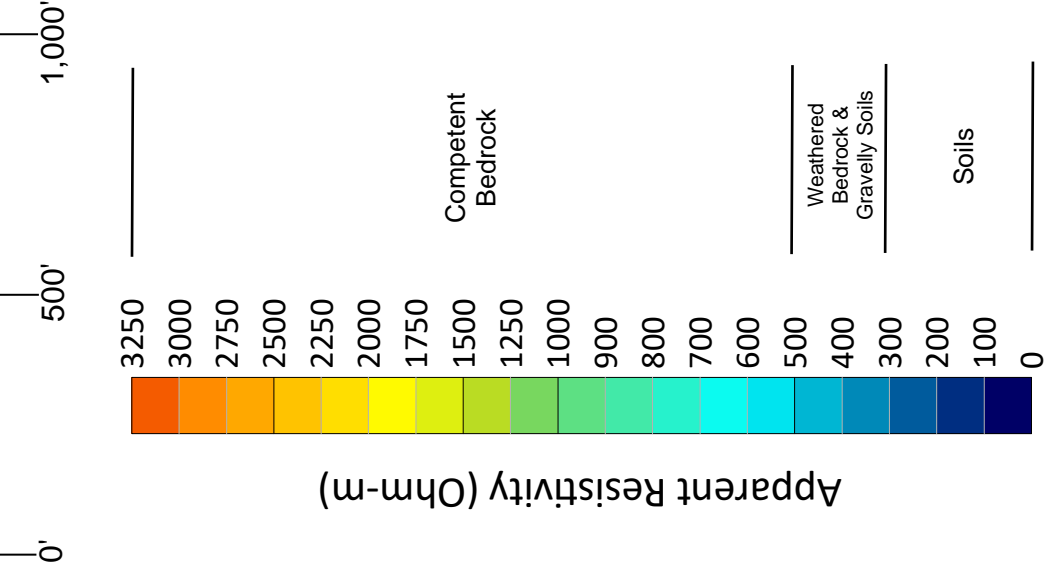
No vertical exaggeration.

Real-time positioning of data using fully integrated Trimble Geo-7X global positioning system set to NAD 1983 New Jersey State coordinate system (US Survey feet).

Locations are approximate.

DRN	JWN	3/1/2022	<p>4405 S Clinton Ave Clinton, NJ 07060 (908) 754-8800 www.anisgeo.com</p>
DES	JWN	3/1/2022	
CHK	TR	3/1/2022	
REV			
PROJ. MGR.	TR	3/1/2022	
SCALE			DRAWING NO.:
SOURCE:			Figure 5
AGI EarthImager 2D			Electrical Resistivity Imaging Profile
PREPARED FOR:			Location 7 & 8 (ERI-7 & ERI-8)
CONCEPT ENGINEERING CONSULTANTS, PA			PROJECT NO.:
			SHEET TITLE:

**Geophysical Investigation  
Clinton Commons Project  
Town of Clinton, New Jersey**



		4405 S Clinton Ave Marlton, NJ 08053 (609) 754-8800 www.anisgeo.com	
DRN	JWN	3/17/2022	PROJECT:
DES	JWN	3/17/2022	<b>Geophysical Investigation          Clinton Commons Project          Town of Clinton, New Jersey</b>
CHK	TR	3/18/2022	
REV			
PROJ. MGR.	TR	3/18/2022	
SCALE			DRAWING NO.:
SOURCE:		AGI Earthmager 2D	Figure 6
PREPARED FOR:		Electrical Resistivity Imaging Profile Location 9 (ERI-9)	
		PROJECT NO.:	
		SHEET TITLE:	
		<b>CONCEPT ENGINEERING CONSULTANTS, PA</b>	

**Notes:**

Geophysical survey conducted February 28 & March 1, 2022 using AGI's Superstring R8 Resistivity continuous vertical electrical sounder with 5 feet and 10 feet spacings, and 28 or 56 Electrode spacings. Data was interpreted using Earthmager 2D inversion software.

No vertical exaggeration.

Real-time positioning of data using fully integrated Trimble Geo-7X global positioning system set to NAD 1983 New Jersey State coordinate system (US Survey feet).

Locations are approximate.

## APPENDIX C

### Investigation Location Plan





Client:

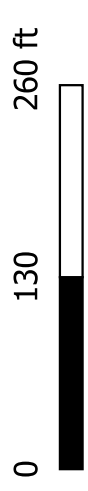
CONCEPT ENGINEERING  
CONSULTANTS, PA

### INVESTIGATION LOCATION PLAN CLINTON COMMONS DEVELOPMENT

TOWN OF CLINTON, NEW JERSEY

#### Legend

- As-Completed ANS Geo Soil Boring Location
- ✗ Cancelled Soil Boring Location
- As-Completed Percussion Probe Location
- As Completed E&LP Soil Borings
- As-Completed Geophysics Locations
- Syncline
- Anticline
- Possible Karst Locations
- - - Concealed Fault
- ▶ Thrust Fault



Absolute Scale: 1 inch = 130 feet  
Scale at 11" x 17" AS SHOWN

Prepared by: Michael Lionikis  
Date: Oct. 07, 2022  
Drawing Number: PIP-1 Rev. 4





## APPENDIX D

### **As-Completed Percussion Probe Logs**





# Percussion Drilling Log

PP - 01

<b>Client:</b> Concept Engineering Consultants	<b>Drilling Firm:</b> Hayduk Enterprises	<b>Coordinates:</b> 40.641144, -74.90875
<b>Project:</b> Clinton Commons	<b>Drill Crew:</b> Garth Devlia	<b>Horiz. Datum:</b> WGS 84
<b>Location:</b> Clinton, NJ	<b>Boring Start:</b> 12:45 am 5/09/2022	<b>Elevation:</b> Grade
<b>Inspector:</b> Michael Garcia	<b>Boring End:</b> 2:00 pm 5/09/2022	<b>Vert. Datum:</b> N/A

<b>Rig Model:</b> Ingersoll-Rand ECM-590	<b>Drill Bit Type:</b> Percussion Drill Bit	<b>Drill Rod Type:</b> N/A
<b>Rig Type:</b> Hydraulic Rock Drill	<b>Drill Bit Length:</b> 6 inches	<b>Drill Rod Length:</b> 12 feet
<b>Drill Method:</b> Top Hammer	<b>Drill Bit I.D.:</b> 3 inches	<b>Drill Rod I.D.:</b> N/A

Depth (ft)	Average Drilling Rate (sec/ft)	Drilling & Observation Notes	Additional Notes
1	6	Light brown coarse to fine SAND, trace Silt  Top of bedrock ~ 7 Ft. BGS.	- 0 to 7 feet BGS Drill Time : 0.75 minutes
2	6		
3	6		
4	6		
5	6		
6	6		
7	9		
8	20		
9	20		
10	20		
11	20		
12	20		
13	17		
14	17		
15	17		
16	17		
17	17		
18	17		
19	32		
20	32		
21	36		
22	38		
23	38		
24	38		
	32		- 7 to 10 feet BGS Drill Time : 1 minute
			- 10 to 15 feet BGS Drill Time : 1.52 minutes
			- 15 to 20 feet BGS Drill Time : 1.91 minutes
			- 20 to 25 feet BGS Drill Time : 3.03 minutes

In-Borehole Water Levels				General Notes
Date / Time	Casing Tip (ft)	Bot. of Hole (ft)	Water Lvl (ft)	
				BGS = Below Grade Surface No groundwater observed.



# Percussion Drilling Log

**PP - 01**  
(continued)

<b>Client:</b> Concept Engineering Consultants	<b>Drilling Firm:</b> Hayduk Enterprises	<b>Coordinates:</b> 40.641144, -74.90875
<b>Project:</b> Clinton Commons	<b>Drill Crew:</b> Garth Devlia	<b>Horiz. Datum:</b> WGS 84
<b>Location:</b> Clinton, NJ	<b>Boring Start:</b> 12:45 am 5/09/2022	<b>Elevation:</b> Grade
<b>Inspector:</b> Michael Garcia	<b>Boring End:</b> 2:00 pm 5/09/2022	<b>Vert. Datum:</b> N/A

Depth (ft)	Average Drilling Rate (sec/ft)	Drilling & Observation Notes	Additional Notes
26	32		- 25 to 30 feet BGS Drill Time : 2.67 minutes
27	32		
28	32		- 30 to 35 feet BGS Drill Time : 2.92 minutes
29	32		
30	30		
31	30		- 35 to 40 feet BGS Drill Time : 3.67 minutes
32	35		
33	40		
34	40		
35	40		- 40 to 45 feet BGS Drill Time : 3 minutes
36	45		
37	45		
38	45		
39	45		
40	42		- 45 to 49 feet BGS Drill Time : 2 minutes
41	42		
42	36		
43	30		
44	30		
45	30		
46	30		Total Drill Time in Rocks : 21.72 minutes
47	30		
48	30		
49		End of Percussion Drilling at 49 feet BGS. Backfilled with cuttings and bentonite holeplug	
50			

In-Borehole Water Levels				General Notes
Date / Time	Casing Tip (ft)	Bot. of Hole (ft)	Water Lvl (ft)	BGS = Below Grade Surface No groundwater observed.





# Percussion Drilling Log

**PP - 02**  
(continued)

<b>Client:</b> Concept Engineering Consultants	<b>Drilling Firm:</b> Hayduk Enterprises	<b>Coordinates:</b> 40.641723, -74.906078
<b>Project:</b> Clinton Commons	<b>Drill Crew:</b> Garth Devlia	<b>Horiz. Datum:</b> WGS 84
<b>Location:</b> Clinton, NJ	<b>Boring Start:</b> 2:45 pm 5/10/2022	<b>Elevation:</b> Grade
<b>Inspector:</b> Michael Garcia	<b>Boring End:</b> 3:20 pm 5/10/2022	<b>Vert. Datum:</b> N/A

Depth (ft)	Average Drilling Rate (sec/ft)	Drilling & Observation Notes	Additional Notes	
26	22		- 25 to 30 feet BGS Drill Time : 1.83 minutes  - 30 to 35 feet BGS Drill Time : 1.83 minutes  - 35 to 40 feet BGS Drill Time : 2.42 minutes  - 40 to 45 feet BGS Drill Time : 1.97 minutes  - 45 to 49 feet BGS Drill Time : 1.6 minutes  Total Drill Time in Rocks : 18.14 minutes	
27	22			
28	22			
29	22			
30	22			
31	20			
32	20			
33	20			
34	25			
35	25			
36	25			
37	30			
38	30			
39	30			
40	30			
41	25			
42	25			
43	20			
44	24			
45	24			
46	24			
47	24			
48	24			
49	24			
50		End of Percussion Drilling at 49 feet BGS. Backfilled with cuttings and bentonite holeplug		

In-Borehole Water Levels				General Notes
Date / Time	Casing Tip (ft)	Bot. of Hole (ft)	Water Lvl (ft)	BGS = Below Grade Surface No groundwater observed.







# Percussion Drilling Log

**PP - 03**  
(continued)

<b>Client:</b> Concept Engineering Consultants	<b>Drilling Firm:</b> Hayduk Enterprises	<b>Coordinates:</b> 40.641496, -74.905962
<b>Project:</b> Clinton Commons	<b>Drill Crew:</b> Garth Devlia	<b>Horiz. Datum:</b> WGS 84
<b>Location:</b> Clinton, NJ	<b>Boring Start:</b> 1:30 pm 5/10/2022	<b>Elevation:</b> Grade
<b>Inspector:</b> Michael Garcia	<b>Boring End:</b> 2:40 pm 5/10/2022	<b>Vert. Datum:</b> N/A

Depth (ft)	Average Drilling Rate (sec/ft)	Drilling & Observation Notes	Additional Notes
26	25		- 25 to 30 feet BGS Drill Time : 2.08 minutes
27	25		
28	25		
29	25		
30	25		
31	28		- 30 to 35 feet BGS Drill Time : 2.68 minutes
32	28		
33	35		
34	35		
35	35		
36	35		- 35 to 40 feet BGS Drill Time : 2.85 minutes
37	34		
38	34		
39	34		
40	34		
41	40		- 40 to 45 feet BGS Drill Time : 3.17 minutes
42	40		
43	40		
44	35		
45	35		
46	35		- 45 to 49 feet BGS Drill Time : 2.33 minutes
47	35		
48	35		
49	35		Total Drill Time in Rocks : 21.20 minutes
50		End of Percussion Drilling at 49 feet BGS. Backfilled with cuttings and bentonite holeplug	

In-Borehole Water Levels				General Notes
Date / Time	Casing Tip (ft)	Bot. of Hole (ft)	Water Lvl (ft)	BGS = Below Grade Surface No groundwater observed.



# Percussion Drilling Log

PP - 04

<b>Client:</b> Concept Engineering Consultants	<b>Drilling Firm:</b> Hayduk Enterprises	<b>Coordinates:</b> 40.640880, -74.907191
<b>Project:</b> Clinton Commons	<b>Drill Crew:</b> Garth Devlia	<b>Horiz. Datum:</b> WGS 84
<b>Location:</b> Clinton, NJ	<b>Boring Start:</b> 12:45 pm 5/09/2022	<b>Elevation:</b> Grade
<b>Inspector:</b> Michael Garcia	<b>Boring End:</b> 2:00 pm 5/09/2022	<b>Vert. Datum:</b> N/A

<b>Rig Model:</b> Ingersoll-Rand ECM-590	<b>Drill Bit Type:</b> Percussion Drill Bit	<b>Drill Rod Type:</b> N/A
<b>Rig Type:</b> Hydraulic Rock Drill	<b>Drill Bit Length:</b> 6 inches	<b>Drill Rod Length:</b> 12 feet
<b>Drill Method:</b> Top Hammer	<b>Drill Bit I.D.:</b> 3 inches	<b>Drill Rod I.D.:</b> N/A

Depth (ft)	Average Drilling Rate (sec/ft)	Drilling & Observation Notes	Additional Notes
1	4	Light brown coarse to fine SAND, trace fine Gravel, trace Silt  Top of bedrock ~ 4 Ft. BGS.	- 0 to 4 feet BGS Drill Time : 0.27 minutes
2	4		
3	4		
4	4		
5	34		
6	34		
7	30		
8	25		
9	25		
10	25		
11	25		
12	25		
13	20		
14	20		
15	20		
16	20		
17	20		
18	20		
19	25		
20	25		
21	30		
22	30		
23	30		
24	30		
	17	Possible Groundwater ~ 24 Ft. BGS.	

In-Borehole Water Levels				General Notes
Date / Time	Casing Tip (ft)	Bot. of Hole (ft)	Water Lvl (ft)	BGS = Below Grade Surface No groundwater observed.



# Percussion Drilling Log

**PP - 04**  
(continued)

<b>Client:</b> Concept Engineering Consultants	<b>Drilling Firm:</b> Hayduk Enterprises	<b>Coordinates:</b> 40.640880, -74.907191
<b>Project:</b> Clinton Commons	<b>Drill Crew:</b> Garth Devlia	<b>Horiz. Datum:</b> WGS 84
<b>Location:</b> Clinton, NJ	<b>Boring Start:</b> 12:45 pm 5/09/2022	<b>Elevation:</b> Grade
<b>Inspector:</b> Michael Garcia	<b>Boring End:</b> 2:00 pm 5/09/2022	<b>Vert. Datum:</b> N/A

Depth (ft)	Average Drilling Rate (sec/ft)	Drilling & Observation Notes	Additional Notes
26	17		- 25 to 30 feet BGS Drill Time : 1.42 minutes
27	17		
28	17		
29	17		
30	17		
31	22		- 30 to 35 feet BGS Drill Time : 1.98 minutes
32	22		
33	15		
34	30		
35	30		
36	30		- 35 to 40 feet BGS Drill Time : 2.17 minutes
37	25		
38	25		
39	25		
40	25		
41	22		- 40 to 45 feet BGS Drill Time : 1.67 minutes
42	22		
43	22		
44	17		
45	17		
46	17		- 45 to 49 feet BGS Drill Time : 1.13 minutes
47	17		
48	17		
49	17		Total Drill Time in Rocks : 17.46 minutes
50		End of Percussion Drilling at 49 feet BGS. Backfilled with cuttings and bentonite holeplug	

In-Borehole Water Levels				General Notes
Date / Time	Casing Tip (ft)	Bot. of Hole (ft)	Water Lvl (ft)	BGS = Below Grade Surface No groundwater observed.



# Percussion Drilling Log

PP - 05

<b>Client:</b> Concept Engineering Consultants	<b>Drilling Firm:</b> Hayduk Enterprises	<b>Coordinates:</b> 40.642606, -74.906809
<b>Project:</b> Clinton Commons	<b>Drill Crew:</b> Garth Devlia	<b>Horiz. Datum:</b> WGS 84
<b>Location:</b> Clinton, NJ	<b>Boring Start:</b> 09:00 am 5/04/2022	<b>Elevation:</b> Grade
<b>Inspector:</b> Michael Garcia	<b>Boring End:</b> 11:00 am 5/04/2022	<b>Vert. Datum:</b> N/A

<b>Rig Model:</b> Ingersoll-Rand ECM-590	<b>Drill Bit Type:</b> Percussion Drill Bit	<b>Drill Rod Type:</b> N/A
<b>Rig Type:</b> Hydraulic Rock Drill	<b>Drill Bit Length:</b> 6 inches	<b>Drill Rod Length:</b> 12 feet
<b>Drill Method:</b> Top Hammer	<b>Drill Bit I.D.:</b> 3 inches	<b>Drill Rod I.D.:</b> N/A

Depth (ft)	Average Drilling Rate (sec/ft)	Drilling & Observation Notes	Additional Notes
1	2	Light brown coarse to fine SAND, trace Silt	- 0 to 10 feet BGS Drill Time : 0.42 minutes
2	2		
3	2		
4	2		
5	3		
6	3		
7	2		
8	3		
9	3		
10	3		
11	3		
12	3		
13	2		
14	2		
15	2		
16	2		
17	4		
18	4		
19	2		
20	6		
21	6		
22	6		
23	6		
24	6		
24	20	Top of bedrock ~ 24 Ft.	- 10 to 24 feet BGS Drill Time : 0.9 minutes

In-Borehole Water Levels				General Notes
Date / Time	Casing Tip (ft)	Bot. of Hole (ft)	Water Lvl (ft)	BGS = Below Grade Surface No groundwater observed.



# Percussion Drilling Log

**PP - 05**  
(continued)

<b>Client:</b> Concept Engineering Consultants	<b>Drilling Firm:</b> Hayduk Enterprises	<b>Coordinates:</b> 40.642606, -74.906809
<b>Project:</b> Clinton Commons	<b>Drill Crew:</b> Garth Devlia	<b>Horiz. Datum:</b> WGS 84
<b>Location:</b> Clinton, NJ	<b>Boring Start:</b> 09:00 am 5/04/2022	<b>Elevation:</b> Grade
<b>Inspector:</b> Michael Garcia	<b>Boring End:</b> 11:00 am 5/04/2022	<b>Vert. Datum:</b> N/A

Depth (ft)	Average Drilling Rate (sec/ft)	Drilling & Observation Notes	Additional Notes
26	20		- 24 to 30 feet BGS Drill Time : 2.0 minutes
27	20		
28	20		
29	20		
30	20		
31	15		- 30 to 35 feet BGS Drill Time : 1.18 minutes
32	14		
33	14		
34	14		
35	14		
36	14		- 35 to 40 feet BGS Drill Time : 1.63 minutes
37	21		
38	21		
39	21		
40	21		
41	26		- 40 to 45 feet BGS Drill Time : 2.17 minutes
42	26		
43	30		
44	24		
45	24		
46	24		- 45 to 49 feet BGS Drill Time : 1.6 minutes
47	24		
48	24		
49	24		Total Drill Time in Rocks : 9.9 minutes
50		End of Percussion Drilling at 49 feet BGS. Backfilled with cuttings and bentonite holeplug	

In-Borehole Water Levels				General Notes
Date / Time	Casing Tip (ft)	Bot. of Hole (ft)	Water Lvl (ft)	BGS = Below Grade Surface No groundwater observed.







# Percussion Drilling Log

**PP - 06**  
(continued)

<b>Client:</b> Concept Engineering Consultants	<b>Drilling Firm:</b> Hayduk Enterprises	<b>Coordinates:</b> 40.641588, -74.907572
<b>Project:</b> Clinton Commons	<b>Drill Crew:</b> Garth Devlia	<b>Horiz. Datum:</b> WGS 84
<b>Location:</b> Clinton, NJ	<b>Boring Start:</b> 12:00 pm 5/04/2022	<b>Elevation:</b> Grade
<b>Inspector:</b> Michael Garcia	<b>Boring End:</b> 1:00 pm 5/04/2022	<b>Vert. Datum:</b> N/A

Depth (ft)	Average Drilling Rate (sec/ft)	Drilling & Observation Notes	Additional Notes
26	22		- 25 to 30 feet BGS Drill Time : 1.83 minutes
27	22		
28	22		
29	22		
30	22		
31	22		- 30 to 35 feet BGS Drill Time : 1.77 minutes
32	21		
33	21		
34	21		
35	21		
36	21		- 35 to 40 feet BGS Drill Time : 2.08 minutes
37	26		
38	26		
39	26		
40	26		
41	23		- 40 to 45 feet BGS Drill Time : 1.78 minutes
42	23		
43	18		
44	18		
45	25		
46	25		- 45 to 49 feet BGS Drill Time : 1.67 minutes
47	25		
48	25		
49	25		Total Drill Time in Rocks : 14.43 minutes
50		End of Percussion Drilling at 49 feet BGS. Backfilled with cuttings and bentonite holeplug	

In-Borehole Water Levels				General Notes
Date / Time	Casing Tip (ft)	Bot. of Hole (ft)	Water Lvl (ft)	BGS = Below Grade Surface No groundwater observed.



# Percussion Drilling Log

PP - 07

<b>Client:</b> Concept Engineering Consultants	<b>Drilling Firm:</b> Hayduk Enterprises	<b>Coordinates:</b> 40.641271, -74.907599
<b>Project:</b> Clinton Commons	<b>Drill Crew:</b> Garth Devlia	<b>Horiz. Datum:</b> WGS 84
<b>Location:</b> Clinton, NJ	<b>Boring Start:</b> 09:00 am 5/09/2022	<b>Elevation:</b> Grade
<b>Inspector:</b> Michael Garcia	<b>Boring End:</b> 11:30 am 5/09/2022	<b>Vert. Datum:</b> N/A
<b>Rig Model:</b> Ingersoll-Rand ECM-590	<b>Drill Bit Type:</b> Percussion Drill Bit	<b>Drill Rod Type:</b> N/A
<b>Rig Type:</b> Hydraulic Rock Drill	<b>Drill Bit Length:</b> 6 inches	<b>Drill Rod Length:</b> 12 feet
<b>Drill Method:</b> Top Hammer	<b>Drill Bit I.D.:</b> 3 inches	<b>Drill Rod I.D.:</b> N/A

Depth (ft)	Average Drilling Rate (sec/ft)	Drilling & Observation Notes	Additional Notes
1	3	Light brown coarse to fine SAND, trace fine Gravel, trace Silt	- 0 to 12 feet BGS Drill Time : 1.13 minutes
2	3		
3	3		
4	3		
5	2		
6	2		
7	7		
8	9		
9	9		
10	9		
11	9		
12	9		
13	27	Top of bedrock ~ 12 Ft. BGS.	- 12 to 20 feet BGS Drill Time : 3.33 minute
14	27		
15	27		
16	27		
17	23		
18	23		
19	23		
20	23		
21	30		
22	30		
23	30		
24	30		

In-Borehole Water Levels				General Notes
Date / Time	Casing Tip (ft)	Bot. of Hole (ft)	Water Lvl (ft)	
				BGS = Below Grade Surface No groundwater observed.



# Percussion Drilling Log

**PP - 07**  
(continued)

<b>Client:</b> Concept Engineering Consultants	<b>Drilling Firm:</b> Hayduk Enterprises	<b>Coordinates:</b> 40.641271, -74.907599
<b>Project:</b> Clinton Commons	<b>Drill Crew:</b> Garth Devlia	<b>Horiz. Datum:</b> WGS 84
<b>Location:</b> Clinton, NJ	<b>Boring Start:</b> 09:00 am 5/09/2022	<b>Elevation:</b> Grade
<b>Inspector:</b> Michael Garcia	<b>Boring End:</b> 11:30 am 5/09/2022	<b>Vert. Datum:</b> N/A

Depth (ft)	Average Drilling Rate (sec/ft)	Drilling & Observation Notes	Additional Notes
26	30		- 25 to 30 feet BGS Drill Time : 2.5 minutes
27	30		
28	30		
29	30		
30	30		
31	33		- 30 to 35 feet BGS Drill Time : 2.75 minutes
32	33		
33	33		
34	33		
35	33		
36	33		- 35 to 40 feet BGS Drill Time : 3.08 minutes
37	38		
38	38		
39	38		
40	38		
41	30		- 40 to 45 feet BGS Drill Time : 2.87 minutes
42	30		
43	36		
44	38		
45	38		
46	38		- 45 to 49 feet BGS Drill Time : 2.53 minutes
47	38		
48	38		
49	38		Total Drill Time in Rocks : 20.69 minutes
50		End of Percussion Drilling at 49 feet BGS. Backfilled with cuttings and bentonite holeplug	

In-Borehole Water Levels				General Notes
Date / Time	Casing Tip (ft)	Bot. of Hole (ft)	Water Lvl (ft)	BGS = Below Grade Surface No groundwater observed.



# Percussion Drilling Log

PP - 08

<b>Client:</b> Concept Engineering Consultants	<b>Drilling Firm:</b> Hayduk Enterprises	<b>Coordinates:</b> 40.642493, -74.907857
<b>Project:</b> Clinton Commons	<b>Drill Crew:</b> Garth Devlia	<b>Horiz. Datum:</b> WGS 84
<b>Location:</b> Clinton, NJ	<b>Boring Start:</b> 11:00 am 5/04/2022	<b>Elevation:</b> Grade
<b>Inspector:</b> Michael Garcia	<b>Boring End:</b> 12:00 am 5/04/2022	<b>Vert. Datum:</b> N/A
<b>Rig Model:</b> Ingersoll-Rand ECM-590	<b>Drill Bit Type:</b> Percussion Drill Bit	<b>Drill Rod Type:</b> N/A
<b>Rig Type:</b> Hydraulic Rock Drill	<b>Drill Bit Length:</b> 6 inches	<b>Drill Rod Length:</b> 12 feet
<b>Drill Method:</b> Top Hammer	<b>Drill Bit I.D.:</b> 3 inches	<b>Drill Rod I.D.:</b> N/A

Depth (ft)	Average Drilling Rate (sec/ft)	Drilling & Observation Notes	Additional Notes	
1	3	Light brown coarse to fine SAND, trace fine Gravel, trace Silt	- 0 to 10 feet BGS Drill Time : 0.67 minutes	
2	3			
3	3			
4	3			
5	7			
6	7			
7	2			
8	4			
9	4			
10	4			
11	4			
12	4			
13	10			
14	10			
15	10			
16	10			
17	10			
18	10			
18	20		Top of bedrock ~ 18Ft. BGS	- 18 to 25 feet BGS Drill Time : 1.83 minutes
19	14			
20	14			
21	14			
22	14			
23	14			
24	14			
24	20			

In-Borehole Water Levels				General Notes
Date / Time	Casing Tip (ft)	Bot. of Hole (ft)	Water Lvl (ft)	
				BGS = Below Grade Surface No groundwater observed.





# Percussion Drilling Log

**PP - 08**  
(continued)

<b>Client:</b> Concept Engineering Consultants	<b>Drilling Firm:</b> Hayduk Enterprises	<b>Coordinates:</b> 40.642493, -74.907857
<b>Project:</b> Clinton Commons	<b>Drill Crew:</b> Garth Devlia	<b>Horiz. Datum:</b> WGS 84
<b>Location:</b> Clinton, NJ	<b>Boring Start:</b> 11:00 am 5/04/2022	<b>Elevation:</b> Grade
<b>Inspector:</b> Michael Garcia	<b>Boring End:</b> 12:00 am 5/04/2022	<b>Vert. Datum:</b> N/A

Depth (ft)	Average Drilling Rate (sec/ft)	Drilling & Observation Notes	Additional Notes
26	20		- 25 to 30 feet BGS Drill Time : 1.7 minutes
27	20		
28	20		
29	21		
30	21		
31	24		- 30 to 35 feet BGS Drill Time : 2.27 minutes
32	28		
33	28		
34	28		
35	28		
36	28		- 35 to 40 feet BGS Drill Time : 2.73 minutes
37	34		
38	34		
39	34		
40	34		
41	35		- 40 to 45 feet BGS Drill Time : 2.77 minutes
42	35		
43	36		
44	30		
45	30		
46	30		- 45 to 49 feet BGS Drill Time : 2.0 minutes
47	30		
48	30		
49	30		Total Drill Time in Rocks : 15.1 minutes
50		End of Percussion Drilling at 49 feet BGS. Backfilled with cuttings and bentonite holeplug	

In-Borehole Water Levels				General Notes
Date / Time	Casing Tip (ft)	Bot. of Hole (ft)	Water Lvl (ft)	BGS = Below Grade Surface No groundwater observed.



# Percussion Drilling Log

PP - 09

<b>Client:</b> Concept Engineering Consultants	<b>Drilling Firm:</b> Hayduk Enterprises	<b>Coordinates:</b> 40.640651, -74.907153
<b>Project:</b> Clinton Commons	<b>Drill Crew:</b> Garth Devlia	<b>Horiz. Datum:</b> WGS 84
<b>Location:</b> Clinton, NJ	<b>Boring Start:</b> 11:45 am 5/10/2022	<b>Elevation:</b> Grade
<b>Inspector:</b> Michael Garcia	<b>Boring End:</b> 1:13 pm 5/10/2022	<b>Vert. Datum:</b> N/A

<b>Rig Model:</b> Ingersoll-Rand ECM-590	<b>Drill Bit Type:</b> Percussion Drill Bit	<b>Drill Rod Type:</b> N/A
<b>Rig Type:</b> Hydraulic Rock Drill	<b>Drill Bit Length:</b> 6 inches	<b>Drill Rod Length:</b> 12 feet
<b>Drill Method:</b> Top Hammer	<b>Drill Bit I.D.:</b> 3 inches	<b>Drill Rod I.D.:</b> N/A

Depth (ft)	Average Drilling Rate (sec/ft)	Drilling & Observation Notes	Additional Notes	
1	5	Light brown coarse to fine SAND, trace fine Gravel, trace Silt  Top of bedrock ~ 6 Ft. BGS.	- 0 to 6 feet BGS Drill Time : 0.67 minutes	
2	5			
3	5			
4	5			
5	10			
6	10			
7	34			- 6 to 10 feet BGS Drill Time : 2.06 minute
8	30			
9	30			
10	30			
11	30			- 10 to 15 feet BGS Drill Time : 2.25 minutes
12	30			
13	25			
14	25			
15	25			
16	25			- 12 to 20 feet BGS Drill Time : 2.08 minutes
17	25			
18	25			
19	25			
20	25			
21	27			- 20 to 25 feet BGS Drill Time : 2.37 minutes
22	30			
23	30			
24	30			
	25			

In-Borehole Water Levels				General Notes
Date / Time	Casing Tip (ft)	Bot. of Hole (ft)	Water Lvl (ft)	BGS = Below Grade Surface No groundwater observed.



# Percussion Drilling Log

**PP - 09**  
(continued)

<b>Client:</b> Concept Engineering Consultants	<b>Drilling Firm:</b> Hayduk Enterprises	<b>Coordinates:</b> 40.640651, -74.907153
<b>Project:</b> Clinton Commons	<b>Drill Crew:</b> Garth Devlia	<b>Horiz. Datum:</b> WGS 84
<b>Location:</b> Clinton, NJ	<b>Boring Start:</b> 11:45 am 5/10/2022	<b>Elevation:</b> Grade
<b>Inspector:</b> Michael Garcia	<b>Boring End:</b> 1:13 pm 5/10/2022	<b>Vert. Datum:</b> N/A

Depth (ft)	Average Drilling Rate (sec/ft)	Drilling & Observation Notes	Additional Notes
26	25		- 25 to 30 feet BGS Drill Time : 2.08 minutes
27	25		
28	25		
29	25		
30	25		
31	30		- 30 to 35 feet BGS Drill Time : 2.5 minutes
32	30		
33	25		
34	30		
35	30		
36	30		- 35 to 40 feet BGS Drill Time : 2.17 minutes
37	25		
38	25		
39	25		
40	25		
41	30		- 40 to 45 feet BGS Drill Time : 2.08 minutes
42	30		
43	25		
44	20		
45	20		
46	20		- 45 to 49 feet BGS Drill Time : 1.33 minutes
47	20		
48	20		
49	20		Total Drill Time in Rocks : 19.59 minutes
50		End of Percussion Drilling at 49 feet BGS. Backfilled with cuttings and bentonite holeplug	

In-Borehole Water Levels				General Notes
Date / Time	Casing Tip (ft)	Bot. of Hole (ft)	Water Lvl (ft)	BGS = Below Grade Surface No groundwater observed.



# Percussion Drilling Log

PP - 10

<b>Client:</b> Concept Engineering Consultants	<b>Drilling Firm:</b> Hayduk Enterprises	<b>Coordinates:</b> 40.641548, -74.907813
<b>Project:</b> Clinton Commons	<b>Drill Crew:</b> Garth Devlia	<b>Horiz. Datum:</b> WGS 84
<b>Location:</b> Clinton, NJ	<b>Boring Start:</b> 08:00 am 5/09/2022	<b>Elevation:</b> Grade
<b>Inspector:</b> Michael Garcia	<b>Boring End:</b> 09:00 am 5/09/2022	<b>Vert. Datum:</b> N/A
<b>Rig Model:</b> Ingersoll-Rand ECM-590	<b>Drill Bit Type:</b> Percussion Drill Bit	<b>Drill Rod Type:</b> N/A
<b>Rig Type:</b> Hydraulic Rock Drill	<b>Drill Bit Length:</b> 6 inches	<b>Drill Rod Length:</b> 12 feet
<b>Drill Method:</b> Top Hammer	<b>Drill Bit I.D.:</b> 3 inches	<b>Drill Rod I.D.:</b> N/A

Depth (ft)	Average Drilling Rate (sec/ft)	Drilling & Observation Notes	Additional Notes													
1	5	Light brown coarse to fine SAND, trace fine Gravel, trace Silt  Top of bedrock ~ 5 Ft. BGS.	- 0 to 5 feet BGS Drill Time : 0.42 minutes													
2	5															
3	5															
4	5															
5	5															
6	20															
7	20															
8	20															
9	20															
10	20															
11	20															
12	20															
13	15															
14	15															
15	15															
16	15															
17	18															
18	18															
19	20															
20	18															
21	18															
22	18															
23	18															
24	20															
<table border="1"> <thead> <tr> <th colspan="3">In-Borehole Water Levels</th> <th rowspan="4">General Notes</th> </tr> <tr> <th>Date / Time</th> <th>Casing Tip (ft)</th> <th>Bot. of Hole (ft)</th> </tr> </thead> <tbody> <tr><td> </td><td> </td><td> </td></tr> <tr><td> </td><td> </td><td> </td></tr> </tbody> </table>			In-Borehole Water Levels			General Notes	Date / Time	Casing Tip (ft)	Bot. of Hole (ft)							BGS = Below Grade Surface No groundwater observed.
In-Borehole Water Levels			General Notes													
Date / Time	Casing Tip (ft)	Bot. of Hole (ft)														



# Percussion Drilling Log

**PP - 10**  
(continued)

<b>Client:</b> Concept Engineering Consultants	<b>Drilling Firm:</b> Hayduk Enterprises	<b>Coordinates:</b> 40.641548, -74.907813
<b>Project:</b> Clinton Commons	<b>Drill Crew:</b> Garth Devlia	<b>Horiz. Datum:</b> WGS 84
<b>Location:</b> Clinton, NJ	<b>Boring Start:</b> 08:00 am 5/09/2022	<b>Elevation:</b> Grade
<b>Inspector:</b> Michael Garcia	<b>Boring End:</b> 09:00 am 5/09/2022	<b>Vert. Datum:</b> N/A

Depth (ft)	Average Drilling Rate (sec/ft)	Drilling & Observation Notes	Additional Notes
26	20		- 25 to 30 feet BGS Drill Time : 1.8 minutes
27	20		
28	20		
29	24		
30	24		
31	22		- 30 to 35 feet BGS Drill Time : 1.7 minutes
32	20		
33	20		
34	20		
35	20		
36	20		- 35 to 40 feet BGS Drill Time : 2.0 minutes
37	25		
38	25		
39	25		
40	25		
41	20		- 40 to 45 feet BGS Drill Time : 1.5 minutes
42	20		
43	15		
44	15		
45	20		
46	20		- 45 to 49 feet BGS Drill Time : 1.33 minutes
47	20		
48	20		
49	20		Total Drill Time in Rocks : 14.85 minutes
50		End of Percussion Drilling at 49 feet BGS. Backfilled with cuttings and bentonite holeplug	

In-Borehole Water Levels				General Notes
Date / Time	Casing Tip (ft)	Bot. of Hole (ft)	Water Lvl (ft)	BGS = Below Grade Surface No groundwater observed.



**APPENDIX E**

**As-Completed Test Boring Logs**



# Soil Boring Log

**B-01**

<b>Client:</b> Concept Engineering Consultants, PA	<b>Drilling Firm:</b> Boring Brothers, Inc	<b>Coordinates:</b> 40.6424972 N,-74.907852 E
<b>Project:</b> Clinton Commons	<b>Drill Crew:</b> M. Daniel / D. Osuch	<b>Horiz. Datum:</b> WGS 84
<b>Location:</b> Clinton, NJ	<b>Boring Start:</b> 9/12/2022 1:30:00 PM	<b>Elevation:</b> Grade
<b>Inspector:</b> Sidharth Nambiar	<b>Boring End:</b> 9/14/2022 9:30:00 AM	<b>Vert. Datum:</b> N/A

<b>Rig Model:</b> CME-55LC	<b>Sampler Type:</b> Split Spoon	<b>Casing Type:</b> Steel Casing
<b>Rig Type:</b> Track	<b>Sampler Length:</b> 24 inches	<b>Casing Length:</b> 5 feet
<b>Drill Method:</b> Mud Rotary	<b>Sampler I.D.:</b> 1.375 inches	<b>Casing I.D.:</b> 4 inches
<b>Hammer Type:</b> Automatic	<b>Hammer Wt.:</b> 140 pounds	<b>Hammer Wt.:</b> 140 pounds
<b>Drilling Fluid:</b> Water	<b>Hammer Fall:</b> 30 inches	<b>Hammer Fall:</b> 30 inches

Depth (ft)	Sample No.	Rec. (in)	Blows per 6"	N-Value	USCS Symbol	Graphic Log	Visual Classification	Toughness	Plasticity	PP (tsf)	TV (tsf)	N-Value				Drilling & Strata Notes		
												10	20	30	40			
5	S-1	18	3 5 20 44	25	ML		Dark brown Clayey SILT, some coarse to fine Sand, dry (ML)	L	L	0.5	1.5							
					GP		Brown to dark gray Sandy coarse to fine GRAVEL, some Silt, dry (GP)											
	S-2	10	17 19 24 49	43	ML		Hard, dark brown SILT, some Clay, trace coarse to fine Gravel, dry (ML)	M	M	3.75	4.0							
	S-3	11	12 17 25 22	42	GM		Dense, dark brown to dark gray Silty coarse to fine GRAVEL, little coarse to fine Sand, moist (GM)										Casing Installed at 4 feet BGS.	
	S-4	11	8 5 6 7	11			Medium dense, dark brown Silty coarse to fine GRAVEL, some coarse to fine Sand, moist (GM)											Casing Installed at 8 feet BGS.
	S-5	4	13 5 6 12	11			Medium dense, dark brown Silty coarse to fine GRAVEL, trace fine Sand, moist (GM)											
	10	S-6	5	8 13 6 4	19	ML		Very stiff, dark brown Clayey SILT, trace coarse to fine Sand, moist (ML)	M	M							Not enough sample for P.P/T.V tests.	
15	S-7	6	2 50/0"	> 50	GM		Very dense, dark brown Silty coarse to fine GRAVEL, some Clay, moist (GM)									Rock fragments at spoon tip. Roller bit refusal at 17 feet BGS.		
							Coring Rock at 17 feet BGS. See Rock Coring Log.											

In-Borehole Water Levels				General Notes	
Date / Time	Casing Tip (ft)	Bot. of Hole (ft)	Water Lvl (ft)		
				▼ = Water Level (if observed) BGS = Below Ground Surface Groundwater was not encountered within this borehole.	
				<b>Toughness:</b> Low (L), Medium (M), High (H) <b>Plasticity:</b> Non-Plastic (NP), Low (L), Medium (M), High (H) <b>PP</b> = Pocket Penetrometer, measured in tons per square ft. <b>TV</b> = Torvane (Shear Vane), measured in tons per square ft.	



# Rock Coring Log

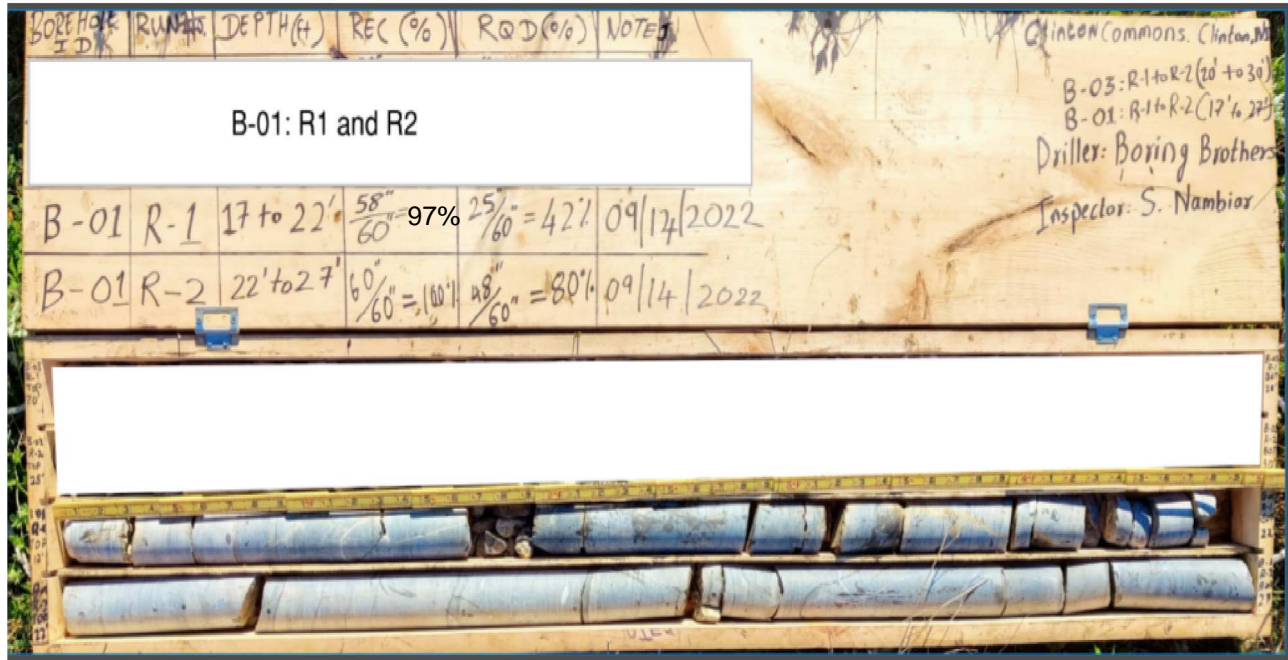
**B-01**

<b>Client:</b> Concept Engineering Consultants, PA	<b>Drilling Firm:</b> Boring Brothers, Inc	<b>Coordinates:</b> 40.6424972 N,-74.907852 E
<b>Project:</b> Clinton Commons	<b>Drill Crew:</b> M. Daniel / D. Osuch	<b>Horiz. Datum:</b> WGS 84
<b>Location:</b> Clinton, NJ	<b>Boring Start:</b> 9/12/2022 1:30:00 PM	<b>Elevation:</b> Grade
<b>Inspector:</b> Sidharth Nambiar	<b>Boring End:</b> 9/14/2022 9:30:00 AM	<b>Vert. Datum:</b> N/A

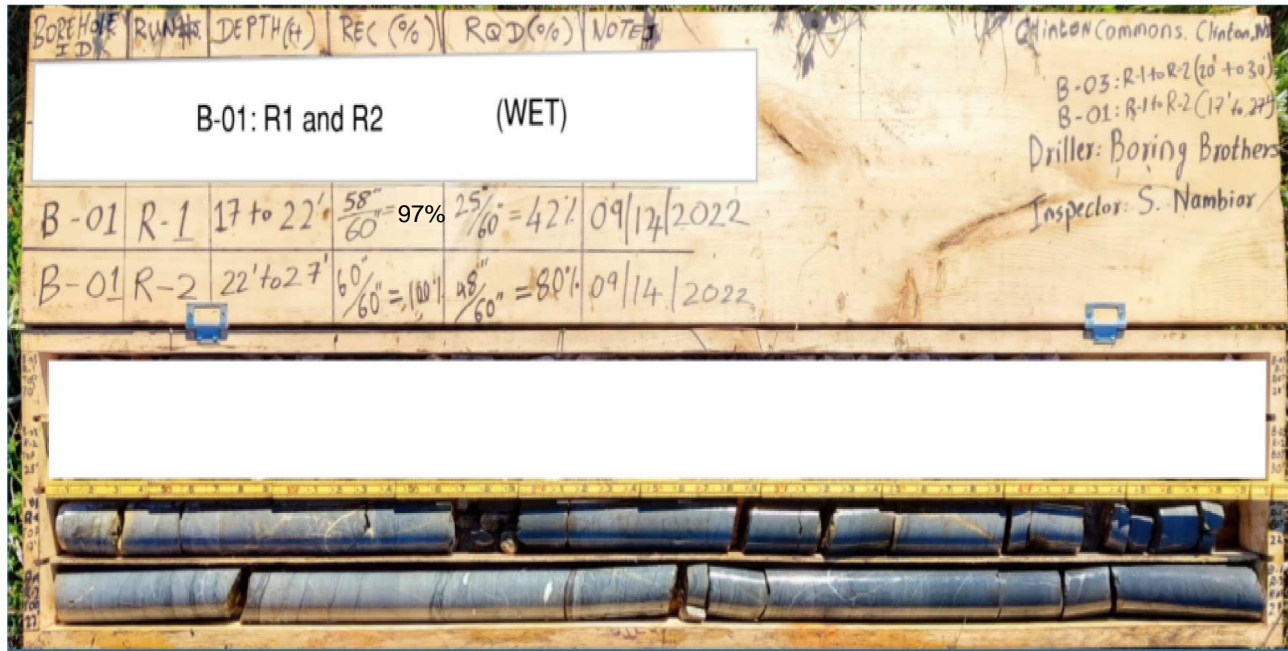
<b>Rig Model:</b> CME-55LC	<b>Casing Type:</b> Steel Casing	<b>Core Barrel Type:</b> NQ	<b>Core Bit Type:</b> NQ - 01
<b>Rig Type:</b> Track	<b>Casing Length:</b> 5 feet	<b>Core Barrel Length:</b> 5 feet	<b>Core Bit Length:</b> 3 inches
<b>Drill Method:</b> Mud Rotary	<b>Casing I.D.:</b> 4 inches	<b>Core Barrel I.D.:</b> 3 inches	<b>Core Bit I.D.:</b> 1.875 inches

Depth (ft)	Avg Core Rate (min/ft)	Run No.	Recovery (in. / %)	RQD (in. / %)	Hardness	Weathering	Graphic Log	Visual Classification	Depth (ft.)	Discontinuities						Drilling & Strata Notes
										Type	Dip Angle	Roughness	Weathering	Aperture	Infilling	
4.97								LIMESTONE, light gray fine grained, slightly weathered, very close to close discontinuity spacing.	18.2	J	50	P,R	FR	VT	N	Casing Installed at 17 feet BGS.
5.08								18.6' to 18.9' Highly Fractured Zone.								Water loss at 18 feet BGS. Calcite veins throughout the cores. Light gray return. Vertical fracture at 6.1 feet BGS.
5.17		R-1	58 97%	25 42%	R4	SL			19.8	J	20	P,Sm	DS	VT	N	
4.83								20.9' to 21.8' Fractured Zone.								
4.92									20.9	J	20	P,Sm	FR	O	N	
5.22								LIMESTONE, light gray fine grained, slightly weathered, close discontinuity spacing.	22.7	J	25	P,R	DS	VT	N	Water loss at 23 feet BGS.
5.13								24.2 to 24.6 Fractured Zone.								
3.72		R-2	60 100%	48 80%					24.2	J	10	P,R	FR	VT	N	
10.7								24.7	J	20	P,R	DS	VT	N		
9.97								26	J	20	P,R	FR	VT	N		
								End of Boring at 27 feet BGS. Backfilled with soil and bentonite holeplug.								

In-Borehole Water Levels				General Notes	
Date / Time	Casing Tip (ft)	Bot. of Hole (ft)	Water Lvl (ft)		
				▼ = Water Level (if observed)      BGS = Below Ground Surface Groundwater was not encountered within this borehole.	



**Figure B-01.1**  
B-01; R-1 and R-2 (dry)



**Figure B-01.2**  
B-01; R-1 and R-2 (wet)

<b>Client:</b> Concept Engineering Consultants, PA	<b>Drilling Firm:</b> Boring Brothers, Inc	<b>Coordinates:</b> 40.6424 N,-74.9066 E
<b>Project:</b> Clinton Commons	<b>Drill Crew:</b> M. Daniel / D. Osuch	<b>Horiz. Datum:</b> WGS 84
<b>Location:</b> Clinton, NJ	<b>Boring Start:</b> 9/12/2022 8:30:00 AM	<b>Elevation:</b> Grade
<b>Inspector:</b> Sidharth Nambiar	<b>Boring End:</b> 9/12/2022 12:30:00 PM	<b>Vert. Datum:</b> N/A

<b>Rig Model:</b> CME-55LC	<b>Sampler Type:</b> Split Spoon	<b>Casing Type:</b> Steel Casing
<b>Rig Type:</b> Track	<b>Sampler Length:</b> 24 inches	<b>Casing Length:</b> 5 feet
<b>Drill Method:</b> Mud Rotary	<b>Sampler I.D.:</b> 1.375 inches	<b>Casing I.D.:</b> 4 inches
<b>Hammer Type:</b> Automatic	<b>Hammer Wt.:</b> 140 pounds	<b>Hammer Wt.:</b> 140 pounds
<b>Drilling Fluid:</b> Water	<b>Hammer Fall:</b> 30 inches	<b>Hammer Fall:</b> 30 inches

Depth (ft)	Sample No.	Rec. (in)	Blows per 6"	N-Value	USCS Symbol	Graphic Log	Visual Classification	Toughness	Plasticity	PP (tsf)	TV (tsf)	N-Value 10 20 30 40	Drilling & Strata Notes	
	S-1	17	5 24 24 22	48	ML		Brown Clayey SILT, trace fine Sand, moist (ML) Gray Sandy coarse to fine GRAVEL, trace Silt, dry (GP)	L	L				Not enough sample for P.P/T.V tests	
	S-2	13	27 28 45 26	> 50	GP		Very dense, light brown to dark gray Sandy coarse to fine GRAVEL, trace Silt, dry (GP)							
5	S-3	8	9 10 8 8	18	SP		Medium dense, light brown to dark gray coarse to fine SAND, some coarse to fine Gravel, trace Silt, dry (SP)					5		
	S-4	1	1 2 2 3	4	GM		Very loose, light brown coarse to fine GRAVEL, some Silt, trace coarse to fine Sand, moist (GM)						Casing installed at 6 feet BGS.	
	S-5	8	4 5 6 5	11			Medium dense, brown to dark brown coarse to fine GRAVEL, some coarse to fine Sand, some Silt, moist (GM)							
10	S-6	4	3 2 2 3	4			Very loose, dark brown Silty coarse to fine GRAVEL, some coarse to fine Sand, moist (GM)						10	Casing installed at 10 feet BGS.
	S-7	7	5 2 5 6	7			Loose, light brown Silty coarse to fine GRAVEL, some Clay, trace coarse to fine Sand, moist (GM)							15
20							Coring Rock at 20 feet BGS. See Rock Coring Log.					20		

In-Borehole Water Levels				General Notes	
Date / Time	Casing Tip (ft)	Bot. of Hole (ft)	Water Lvl (ft)		
				▼ = Water Level (if observed) BGS = Below Ground Surface Groundwater was not encountered within this borehole.	
				<b>Toughness:</b> Low (L), Medium (M), High (H) <b>Plasticity:</b> Non-Plastic (NP), Low (L), Medium (M), High (H) <b>PP</b> = Pocket Penetrometer, measured in tons per square ft. <b>TV</b> = Torvane (Shear Vane), measured in tons per square ft.	





# Rock Coring Log

**B-03**

<b>Client:</b> Concept Engineering Consultants, PA	<b>Drilling Firm:</b> Boring Brothers, Inc	<b>Coordinates:</b> 40.6424 N,-74.9066 E
<b>Project:</b> Clinton Commons	<b>Drill Crew:</b> M. Daniel / D. Osuch	<b>Horiz. Datum:</b> WGS 84
<b>Location:</b> Clinton, NJ	<b>Boring Start:</b> 9/12/2022 8:30:00 AM	<b>Elevation:</b> Grade
<b>Inspector:</b> Sidharth Nambiar	<b>Boring End:</b> 9/12/2022 12:30:00 PM	<b>Vert. Datum:</b> N/A

<b>Rig Model:</b> CME-55LC	<b>Casing Type:</b> Steel Casing	<b>Core Barrel Type:</b> NQ	<b>Core Bit Type:</b> NQ - 01
<b>Rig Type:</b> Track	<b>Casing Length:</b> 5 feet	<b>Core Barrel Length:</b> 5 feet	<b>Core Bit Length:</b> 3 inches
<b>Drill Method:</b> Mud Rotary	<b>Casing I.D.:</b> 4 inches	<b>Core Barrel I.D.:</b> 3 inches	<b>Core Bit I.D.:</b> 1.875 inches

Depth (ft)	Avg Core Rate (min/ft)	Run No.	Recovery (in. / %)	RQD (in. / %)	Hardness	Weathering	Graphic Log	Visual Classification	Depth (ft.)	Discontinuities						Drilling & Strata Notes
										Type	Dip Angle	Roughness	Weathering	Aperture	Infilling	
3.25								LIMESTONE, light gray very fine grained, slightly weathered, very close to close discontinuity spacing.  20' to 25' Highly Fractured Zone.							Water loss encountered at 22 feet BGS.	
3.22																
3.25	R-1	52 87%	0 0%	R3	SL											
3.28																
3.37																
25								LIMESTONE, dark gray very fine grained, slightly weathered, very close to close discontinuity spacing.  25' to 30' Highly Fractured Zone.								
4.75																
5.88																
5.77	R-2	29 48%	0 0%	R3	SL											
2.383																
30								End of Boring at 30 feet BGS. Backfilled with soil and bentonite holeplug.								
35																

In-Borehole Water Levels				General Notes	
Date / Time	Casing Tip (ft)	Bot. of Hole (ft)	Water Lvl (ft)		
				▼ = Water Level (if observed)      BGS = Below Ground Surface Groundwater was not encountered within this borehole.	

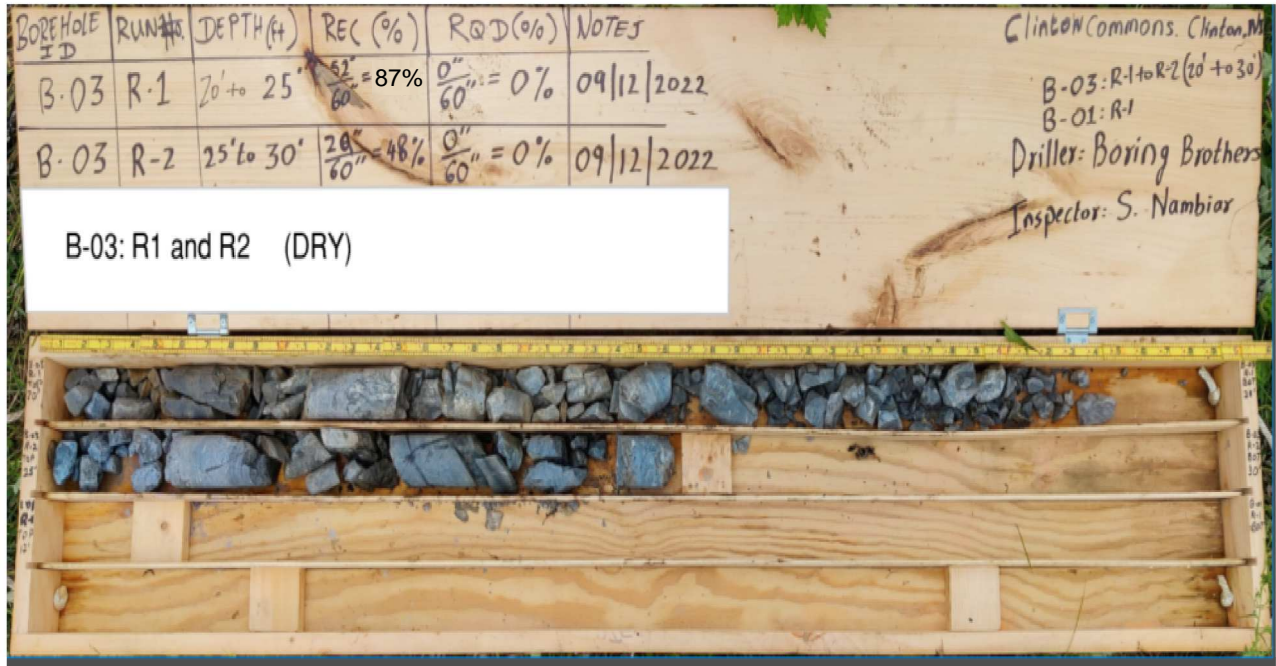


Figure B-03.1  
B-03; R-1 and R-2 (dry)

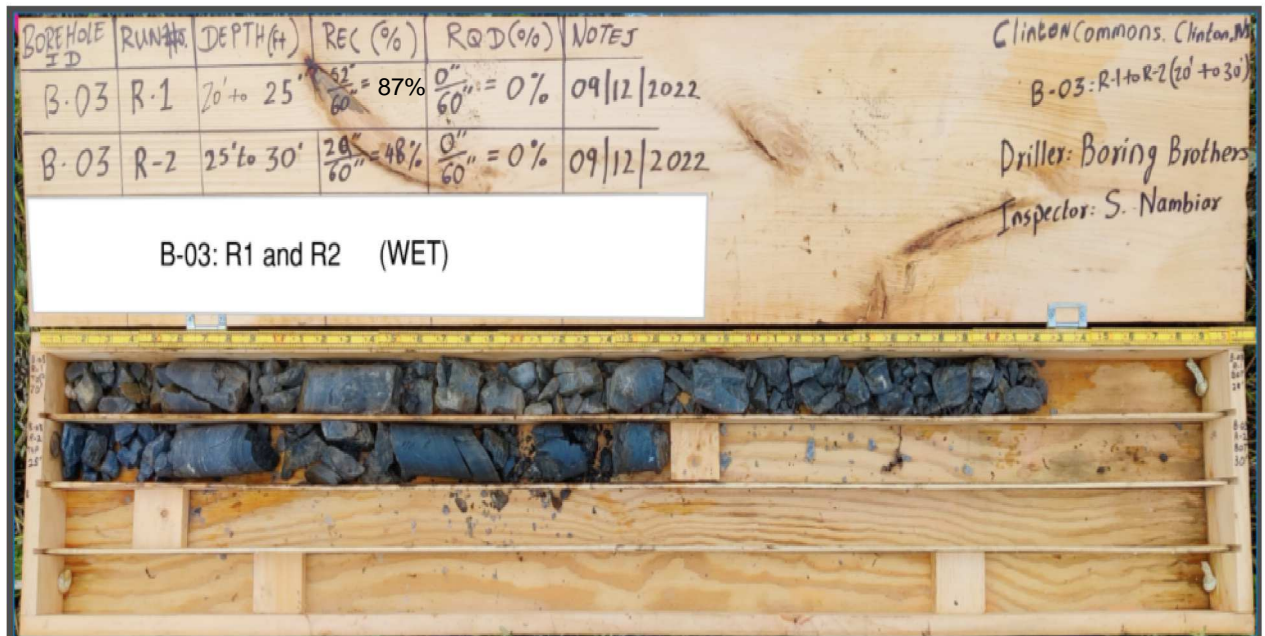


Figure B-03.2  
B-03; R-1 and R-2 (wet)



# Soil Boring Log

**B-04**

<b>Client:</b> Concept Engineering Consultants, PA	<b>Drilling Firm:</b> Boring Brothers, Inc	<b>Coordinates:</b> 40.64157 N,-74.907675 E
<b>Project:</b> Clinton Commons	<b>Drill Crew:</b> M. Daniel / D. Osuch	<b>Horiz. Datum:</b> WGS 84
<b>Location:</b> Clinton, NJ	<b>Boring Start:</b> 9/14/2022 9:45:00 AM	<b>Elevation:</b> Grade
<b>Inspector:</b> Sidharth Nambiar	<b>Boring End:</b> 9/14/2022 12:15:00 PM	<b>Vert. Datum:</b> N/A

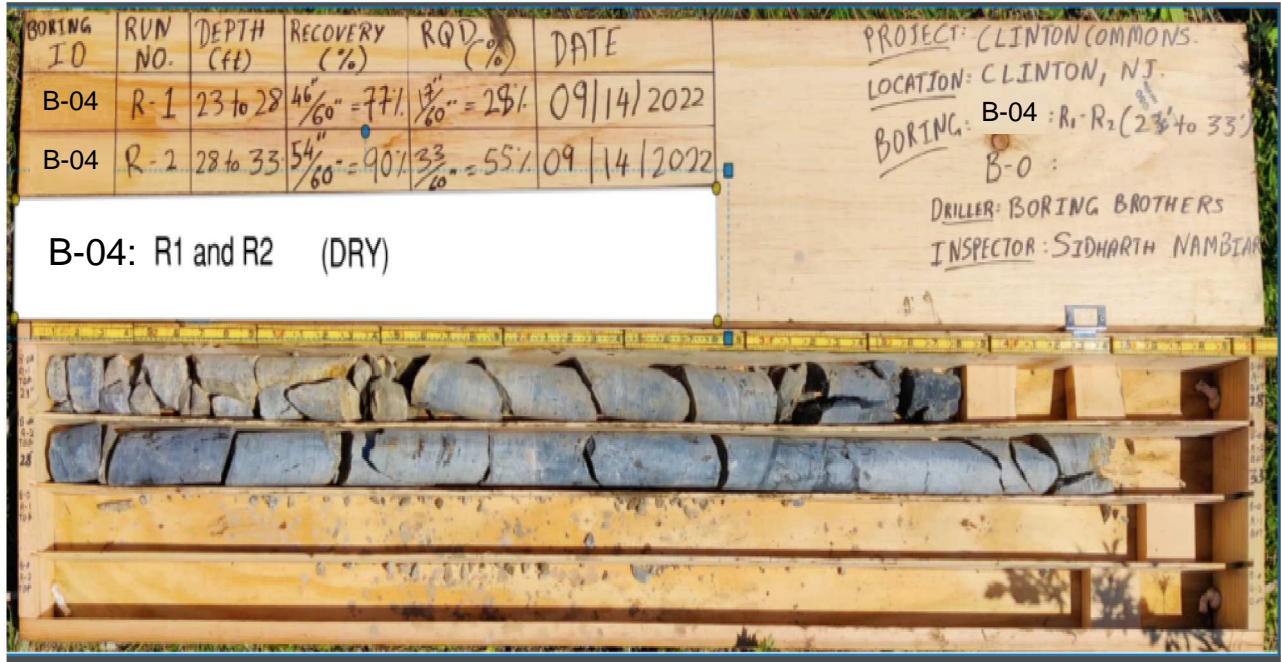
<b>Rig Model:</b> CME-55LC	<b>Sampler Type:</b> Split Spoon	<b>Casing Type:</b> Steel Casing
<b>Rig Type:</b> Track	<b>Sampler Length:</b> 24 inches	<b>Casing Length:</b> 5 feet
<b>Drill Method:</b> Mud Rotary	<b>Sampler I.D.:</b> 1.375 inches	<b>Casing I.D.:</b> 4 inches
<b>Hammer Type:</b> Automatic	<b>Hammer Wt.:</b> 140 pounds	<b>Hammer Wt.:</b> 140 pounds
<b>Drilling Fluid:</b> Water	<b>Hammer Fall:</b> 30 inches	<b>Hammer Fall:</b> 30 inches

Depth (ft)	Sample No.	Rec. (in)	Blows per 6"	N-Value	USCS Symbol	Graphic Log	Visual Classification	Toughness	Plasticity	PP (tsf)	TV (tsf)	N-Value 10 20 30 40	Drilling & Strata Notes
	S-1	10	9 3 9 10	12	ML		Dark brown SILT, some Clay, trace coarse to fine Sand, dry (ML)	L	L	0.75	1.0		
					GP		Brown to dark gray coarse to fine GRAVEL, some coarse to fine Sand, trace Silt, dry (GP)						Not enough sample for P./T.V tests
	S-2	10	6 10 6 3	16	ML		Very stiff, gray to brown SILT, some coarse to fine Gravel, trace Clay, dry (ML)	L	M				
5	S-3	2	2 2 1 2	3			Very loose, brown to gray coarse to fine GRAVEL, some Silt, trace Clay, moist (GM)						Casing installed at 4 feet BGS.
	S-4	9	1 4 6 5	10			Loose, brown to dark brown Silty coarse to fine GRAVEL, trace coarse to fine Sand, moist (GM)						
	S-5	9	9 34 50/5"	> 50	GM		Very dense, gray to brown coarse to fine GRAVEL, some coarse to fine Sand, some Silt, moist (GM)						Casing installed at 8 feet BGS. Weathered Rock.
10	S-6	6	10 7 7 3	14			Medium dense, gray to dark brown Silty coarse to fine GRAVEL, some coarse to fine Sand, moist (GM)						Weathered Rock.
													Roller bit drilled down to 15 feet BGS.
15	S-7	12	3 5 5 6	10	ML		Stiff, dark brown SILT, some coarse to fine Sand, trace Clay, moist (ML)	L	L	2.25	0.5		
					ML								
20	S-8	18	2 4 7 13	11			Stiff, brown to dark gray Sandy coarse to fine SILT, little coarse to fine Gravel, trace Clay, moist (ML)						
							Coring Rock at 23 feet BGS. See Rock Coring Log.						

In-Borehole Water Levels				General Notes	
Date / Time	Casing Tip (ft)	Bot. of Hole (ft)	Water Lvl (ft)		
				▼ = Water Level (if observed) BGS = Below Ground Surface Groundwater was not encountered within this borehole.	
				<b>Toughness:</b> Low (L), Medium (M), High (H) <b>Plasticity:</b> Non-Plastic (NP), Low (L), Medium (M), High (H) <b>PP</b> = Pocket Penetrometer, measured in tons per square ft. <b>TV</b> = Torvane (Shear Vane), measured in tons per square ft.	







**Figure B-04.1**  
B-04; R-1 and R-2 (dry)



**Figure B-04.2**  
B-04; R-1 and R-2 (wet)





# Soil Boring Log

**B-05**

<b>Client:</b> Concept Engineering Consultants, PA	<b>Drilling Firm:</b> Boring Brothers, Inc	<b>Coordinates:</b> 40.640769 N, -74.907358 E
<b>Project:</b> Clinton Commons	<b>Drill Crew:</b> Rob Dollar / Lyle Delmeir	<b>Horiz. Datum:</b> NAD83
<b>Location:</b> Clinton, NJ	<b>Boring Start:</b> 5/13/2022 12:00:00 PM	<b>Elevation:</b> Grade
<b>Inspector:</b> Michael Garcia	<b>Boring End:</b> 5/13/2022 1:45:00 PM	<b>Vert. Datum:</b> N/A

<b>Rig Model:</b> CME-55LC	<b>Sampler Type:</b> Split Spoon	<b>Casing Type:</b> Steel Casing
<b>Rig Type:</b> Track	<b>Sampler Length:</b> 24 inches	<b>Casing Length:</b> 5 feet
<b>Drill Method:</b> Mud Rotary	<b>Sampler I.D.:</b> 1.375 inches	<b>Casing I.D.:</b> 4 inches
<b>Hammer Type:</b> Automatic	<b>Hammer Wt.:</b> 140 pounds	<b>Hammer Wt.:</b> 140 pounds
<b>Drilling Fluid:</b> Water	<b>Hammer Fall:</b> 30 inches	<b>Hammer Fall:</b> 30 inches

Depth (ft)	Sample No.	Rec. (ft)	Blows per 6"	N-Value	USCS Symbol	Graphic Log	Visual Classification	Toughness	Plasticity	PP (tsf)	TV (tsf)	N-Value				Drilling & Strata Notes		
												10	20	30	40			
3.3	S-1	19	4 5 10 12	15	SP		Medium dense, light gray to brown medium to fine SAND, some coarse to fine Gravel, trace Silt, moist (SP)											
3.3 - 4.0	S-2	20	22 30 50/4"	> 50			Medium dense, light gray medium to fine SAND, some coarse to fine Gravel, trace Silt, dry (SP)											Split spoon refusal at 3.3 feet BGS. Roller bit down to 4 feet BGS. Water return was light gray. Roller bit refusal at 4 feet BGS.
4.0 - 4.5							Coring Rock at 4 feet BGS See Rock Coring Log											

In-Borehole Water Levels				General Notes	
Date / Time	Casing Tip (ft)	Bot. of Hole (ft)	Water Lvl (ft)		
				▼ = Water Level (if observed) BGS = Below Ground Surface Groundwater was not encountered within this borehole.	
				<b>Toughness:</b> Low (L), Medium (M), High (H) <b>Plasticity:</b> Non-Plastic (NP), Low (L), Medium (M), High (H) <b>PP</b> = Pocket Penetrometer, measured in tons per square ft. <b>TV</b> = Torvane (Shear Vane), measured in tons per square ft.	



# Rock Coring Log

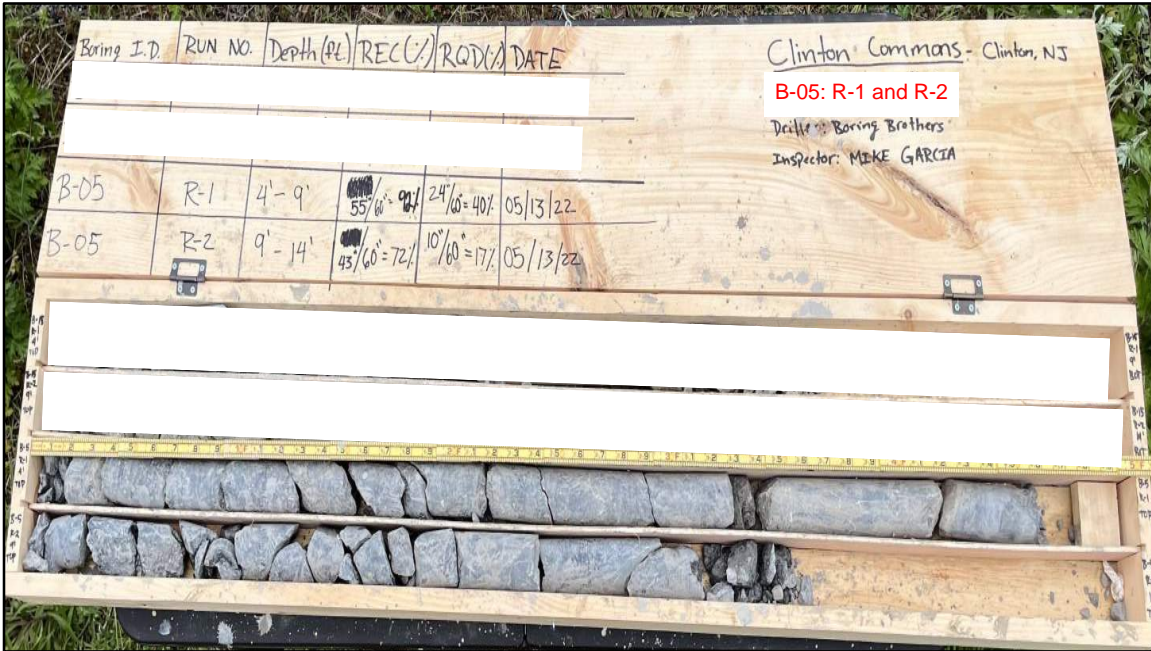
**B-05**

<b>Client:</b> Concept Engineering Consultants, PA	<b>Drilling Firm:</b> Boring Brothers, Inc	<b>Coordinates:</b> 40.640769 N, -74.907358 E
<b>Project:</b> Clinton Commons	<b>Drill Crew:</b> Rob Dollar / Lyle Delmeir	<b>Horiz. Datum:</b> NAD83
<b>Location:</b> Clinton, NJ	<b>Boring Start:</b> 5/13/2022 12:00:00 PM	<b>Elevation:</b> Grade
<b>Inspector:</b> Michael Garcia	<b>Boring End:</b> 5/13/2022 1:45:00 PM	<b>Vert. Datum:</b> N/A

<b>Rig Model:</b> CME-55LC	<b>Casing Type:</b> Steel Casing	<b>Core Barrel Type:</b> NQ	<b>Core Bit Type:</b> NQ - 01
<b>Rig Type:</b> Track	<b>Casing Length:</b> 5 feet	<b>Core Barrel Length:</b> 5 feet	<b>Core Bit Length:</b> 3 inches
<b>Drill Method:</b> Mud Rotary	<b>Casing I.D.:</b> 4 inches	<b>Core Barrel I.D.:</b> 3 inches	<b>Core Bit I.D.:</b> 1.875 inches

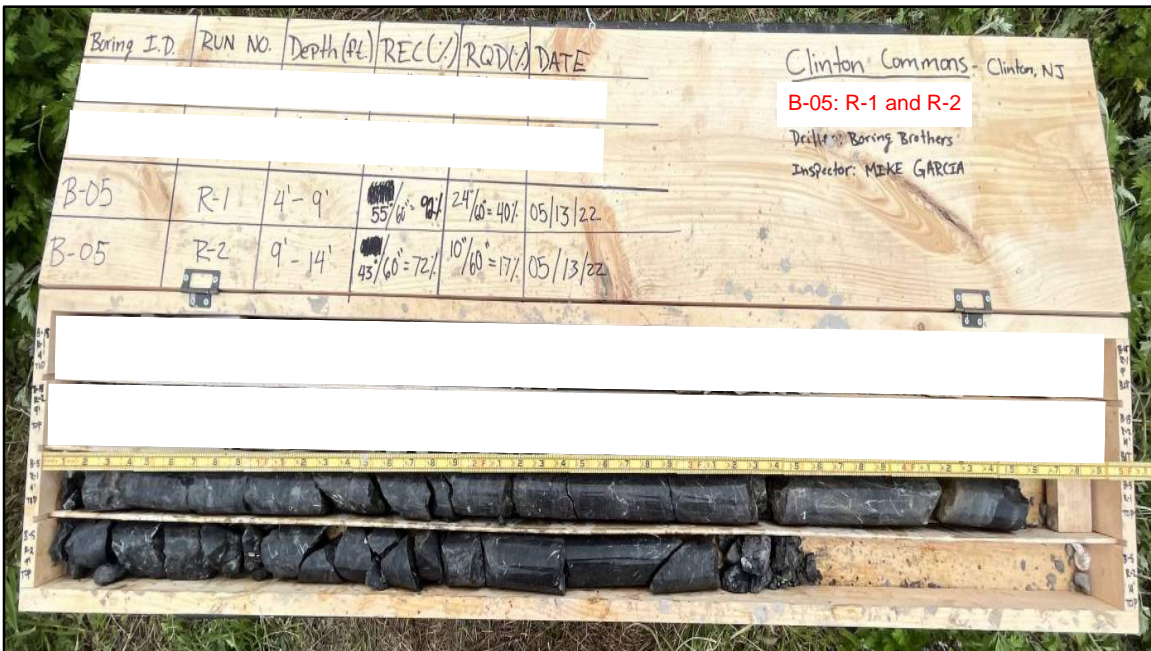
Depth (ft)	Avg Core Rate (min/ft)	Run No.	Recovery (in. / %)	RQD (in. / %)	Hardness	Weathering	Graphic Log	Visual Classification	Depth (ft.)	Discontinuities						Drilling & Strata Notes	
										Type	Dip Angle	Roughness	Weathering	Aperture	Infilling		
5	5.78	R-1	55 92%	24 40%	R3	M		LIMESTONE, light gray coarse to fine grained, moderately weathered, medium strong, very close to close discontinuity spacing.									Calcite veins throughout the cores. Light gray return.  Vertical fracture at 5.2 feet BGS.
	3.75																
	3.83																
	3.90																
	5.92																
10	4.72	R-2	43 72%	10 17%	R3	M		LIMESTONE, light gray coarse to fine grained, moderately weathered, medium strong, very close to close discontinuity spacing.									Calcite veins throughout the cores. Light gray return. Vertical fracture at 9.29 feet BGS.
	4.37																
	4.43																
	4.08																
	4.23																
15								End of Boring at 14 feet BGS. Backfilled with soil and bentonite holeplug.									

In-Borehole Water Levels				General Notes	
Date / Time	Casing Tip (ft)	Bot. of Hole (ft)	Water Lvl (ft)		
				▼ = Water Level (if observed)      BGS = Below Ground Surface Groundwater was not encountered within this borehole.	



**Figure B-05.1**

**B-05; R-1 and R-2 (dry)**



**Figure B-05.2**

**B-05; R-1 and R-2 (wet)**



# Soil Boring Log

**B-06**

**Client:** Concept Engineering Consultants, PA  
**Project:** Clinton Commons  
**Location:** Clinton, NJ  
**Inspector:** Michael Garcia

**Drilling Firm:** Boring Brothers, Inc  
**Drill Crew:** Rob Dollar / Lyle Delmeir  
**Boring Start:** 5/12/2022 8:30:00 AM  
**Boring End:** 5/12/2022 11:05:00 AM

**Coordinates:** 40.6415 N, -74.905967 E  
**Horiz. Datum:** NAD83  
**Elevation:** Grade  
**Vert. Datum:** N/A

**Rig Model:** CME-55LC  
**Rig Type:** Track  
**Drill Method:** Mud Rotary  
**Hammer Type:** Automatic  
**Drilling Fluid:** Water

**Sampler Type:** Split Spoon  
**Sampler Length:** 24 inches  
**Sampler I.D.:** 1.375 inches  
**Hammer Wt.:** 140 pounds  
**Hammer Fall:** 30 inches

**Casing Type:** Steel Casing  
**Casing Length:** 5 feet  
**Casing I.D.:** 4 inches  
**Hammer Wt.:** 140 pounds  
**Hammer Fall:** 30 inches

Depth (ft)	Sample No.	Rec. (ft)	Blows per 6"	N-Value	USCS Symbol	Graphic Log	Visual Classification	Toughness	Plasticity	PP (tsf)	TV (tsf)	N-Value				Drilling & Strata Notes
												10	20	30	40	
	S-1	12	2 4 2 2	6	SP		Loose, dark brown medium to fine SAND, trace Silt, dry (SP)									
	S-2	15	2 3 3 4	6			Medium stiff light brown CLAY, some fine Sand, some Silt, dry (CL)									
5	S-3	13	4 4 3 3	7	CL		Medium stiff light brown CLAY, some fine Sand, some Silt, dry (CL)									
	S-4	12	4 6 50/5"	> 50			Stiff light brown CLAY, some Silt, trace fine Sand, moist (CL)								>>	Casing installed to 7 feet BGS.
	S-5	3	50/3"	> 50	GP		Very dense light to dark gray coarse GRAVEL, moist (GP)								>>	Split spoon refusal at 8.25 feet BGS.
10							Coring Rock at 10 feet BGS See Rock Coring Log									Roller bit down to 10 feet BGS. Water return was light gray. Roller bit refusal at 10 feet BGS.

In-Borehole Water Levels				General Notes	
Date / Time	Casing Tip (ft)	Bot. of Hole (ft)	Water Lvl (ft)		
				▼ = Water Level (if observed) BGS = Below Ground Surface Groundwater was not encountered within this borehole.	

**Toughness:** Low (L), Medium (M), High (H)  
**Plasticity:** Non-Plastic (NP), Low (L), Medium (M), High (H)  
**PP** = Pocket Penetrometer, measured in tons per square ft.  
**TV** = Torvane (Shear Vane), measured in tons per square ft.



# Rock Coring Log

**B-06**

<b>Client:</b> Concept Engineering Consultants, PA	<b>Drilling Firm:</b> Boring Brothers, Inc	<b>Coordinates:</b> 40.6415 N, -74.905967 E
<b>Project:</b> Clinton Commons	<b>Drill Crew:</b> Rob Dollar / Lyle Delmeir	<b>Horiz. Datum:</b> NAD83
<b>Location:</b> Clinton, NJ	<b>Boring Start:</b> 5/12/2022 8:30:00 AM	<b>Elevation:</b> Grade
<b>Inspector:</b> Michael Garcia	<b>Boring End:</b> 5/12/2022 11:05:00 AM	<b>Vert. Datum:</b> N/A

<b>Rig Model:</b> CME-55LC	<b>Casing Type:</b> Steel Casing	<b>Core Barrel Type:</b> NQ	<b>Core Bit Type:</b> NQ - 01
<b>Rig Type:</b> Track	<b>Casing Length:</b> 5 feet	<b>Core Barrel Length:</b> 5 feet	<b>Core Bit Length:</b> 3 inches
<b>Drill Method:</b> Mud Rotary	<b>Casing I.D.:</b> 4 inches	<b>Core Barrel I.D.:</b> 3 inches	<b>Core Bit I.D.:</b> 1.875 inches

Depth (ft)	Avg Core Rate (min/ft)	Run No.	Recovery (in. / %)	RQD (in. / %)	Hardness	Weathering	Graphic Log	Visual Classification	Depth (ft.)	Discontinuities						Drilling & Strata Notes
										Type	Dip Angle	Roughness	Weathering	Aperture	Infilling	
3.10								LIMESTONE, light to dark gray, coarse to fine grained, moderately weathered, weak, very close discontinuity spacing.							Calcite veins throughout the cores. Light gray return. Vertical fracture at 10.7 feet BGS.	
3.23							11.75		J	68	S,R	DS	T	N		
4.00		R-1	60 100%	27 45%	R3	M	12		J	64	S,R	DS	T	N		
3.73							12.8		S	78	S,R	DS	T	N		
3.92							13.4		S	55	S,R	DS	T	N		
15							14.3		J	60	S,R	DS	T	N		
3.00							14.3		J	60	S,R	DS	T	N		
3.25							15		J	55	S,R	DS	T	N		
2.80		R-2	60 100%	58 97%	R3	M	15.81		S	71	S,R	DS	T	N		
3.67							17.08		J	40	S,R	DS	T	N		
5.92							17.75		J	44	S,R	DS	T	N		
20							18.25		J	58	S,R	DS	T	N		
2.88							18.65		J	60	S,R	DS	T	N		
4.08							20.8		S	40	S,R	DS	T	N		
5.25		R-3	60 100%	52 87%	R3	M	21.19		J	65	S,R	DS	T	N		
5							22.65	J	40	S,R	DS	T	N			
5.93							23.3	J	45	S,R	DS	T	N			
25							24.01	J	35	S,R	DS	T	N			
3.77							25	J	33	S,R	DS	T	N			
3.67							26.01	J	52	S,R	DS	T	N			
5.87		R-4	60 100%	56 93%	R3	M	26.22	J	61	S,R	DS	T	N			
6.72							28.2	J	33	S,R	DS	T	N			
7															Iron stains throughout the cores. Calcite veins throughout the cores. Light gray return. Vertical fracture at 20.08 feet BGS.	

In-Borehole Water Levels				General Notes	
Date / Time	Casing Tip (ft)	Bot. of Hole (ft)	Water Lvl (ft)		
				▼ = Water Level (if observed)      BGS = Below Ground Surface Groundwater was not encountered within this borehole.	
				Borehole camera was attempted, but unable to see due to color of water in the borehole.	





# Rock Coring Log

**B-06**  
(Continued)

**Client:** Concept Engineering Consultants, PA  
**Project:** Clinton Commons  
**Location:** Clinton, NJ  
**Inspector:** Michael Garcia

**Drilling Firm:** Boring Brothers, Inc  
**Drill Crew:** Rob Dollar / Lyle Delmeir  
**Boring Start:** 5/12/2022 8:30:00 AM  
**Boring End:** 5/12/2022 11:05:00 AM

**Coordinates:** 40.6415 N, -74.905967 E  
**Horiz. Datum:** NAD83  
**Elevation:** Grade  
**Vert. Datum:** N/A

Depth (ft)	Avg Core Rate (min/ft)	Run No.	Recovery (in. / %)	RQD (in. / %)	Hardness	Weathering	Graphic Log	Visual Classification	Depth (ft.)	Discontinuities						Drilling & Strata Notes
										Type	Dip Angle	P,R	Roughness	Weathering	Aperture	
3.27								LIMESTONE, light gray, coarse to medium grained, moderately weathered, medium strong, very close discontinuity spacing.  31.3' to 34.4' Fractured Rock.	30	J	60	P,R	DS	VT	N	Calcite veins throughout the cores. Light gray return.
3.42							30.5		J	40	P,R	DS	VT	N		
3.52		R-5	60 100%	34 57%	R3	M			33.75	J	60	S,R	DS	T	N	
3.32									34.1	J	50	S,R	DS	T	N	
3.5									34.45	J	30	S,R	DS	T	N	
35								35	J	40	S,R	DS	T	N	Calcite veins throughout the cores. Light gray return.	
3.15								35.5	S	50	S,R	DS	T	N		
2.63																
3.50		R-6	59 98%	49 82%	R3	M		37.75	J	50	S,R	DS	T	N		
4.17								38.4	J	30	S,R	DS	T	N		
40																
40								End of Boring at 40 feet BGS. Backfilled with soil and bentonite holeplug.								
45																
50																

**In-Borehole Water Levels**

**General Notes**

Date / Time	Casing Tip (ft)	Bot. of Hole (ft)	Water Lvl (ft)

▼ = Water Level (if observed)      BGS = Below Ground Surface  
 Groundwater was not encountered within this borehole.



**Figure B-06.1**  
B-06; R-1, R-2, R-3 and R-4 (dry)



**Figure B-06.2**  
B-06; R-1, R-2, R-3 and R-4 (wet)





**Figure B-06.3**  
B-06; R-5 and R-6 (dry)



**Figure B-06.4**  
B-06; R-5 and R-6 (wet)



# Soil Boring Log

**B-07**

<b>Client:</b> Concept Engineering Consultants, PA	<b>Drilling Firm:</b> Boring Brothers, Inc	<b>Coordinates:</b> 40.64176389 N,-74.9069028 E
<b>Project:</b> Clinton Commons	<b>Drill Crew:</b> M. Daniel / D. Osuch	<b>Horiz. Datum:</b> WGS 84
<b>Location:</b> Clinton, NJ	<b>Boring Start:</b> 9/14/2022 1:00:00 PM	<b>Elevation:</b> Grade
<b>Inspector:</b> Sidharth Nambiar	<b>Boring End:</b> 9/14/2022 3:30:00 PM	<b>Vert. Datum:</b> N/A

<b>Rig Model:</b> CME-55LC	<b>Sampler Type:</b> Split Spoon	<b>Casing Type:</b> Steel Casing
<b>Rig Type:</b> Track	<b>Sampler Length:</b> 24 inches	<b>Casing Length:</b> 5 feet
<b>Drill Method:</b> Mud Rotary	<b>Sampler I.D.:</b> 1.375 inches	<b>Casing I.D.:</b> 4 inches
<b>Hammer Type:</b> Automatic	<b>Hammer Wt.:</b> 140 pounds	<b>Hammer Wt.:</b> 140 pounds
<b>Drilling Fluid:</b> Water	<b>Hammer Fall:</b> 30 inches	<b>Hammer Fall:</b> 30 inches

Depth (ft)	Sample No.	Rec. (in)	Blows per 6"	N-Value	USCS Symbol	Graphic Log	Visual Classification	Toughness	Plasticity	PP (tsf)	TV (tsf)	N-Value				Drilling & Strata Notes	
												10	20	30	40		
5	S-1	10	4 24 38 40	> 50	ML		Brown SILT, trace coarse to fine Sand, dry (ML) Gray Gravelly coarse to fine SAND, some Silt, dry (SP)									6" Topsoil.	
	S-2	10	23 16 22 50/5"	> 50	SP		Very dense, gray coarse to fine SAND, some coarse to fine Gravel, some Silt, dry (SP)										
	S-3	0	50/2"	> 50			No recovery.										Casing installed at 4 feet BGS.
5							Coring Rock at 5 feet BGS. See Rock Coring Log.										
10																	
15																	
20																	

In-Borehole Water Levels				General Notes	
Date / Time	Casing Tip (ft)	Bot. of Hole (ft)	Water Lvl (ft)		
				▼ = Water Level (if observed) <b>BGS</b> = Below Ground Surface Groundwater was not encountered within this borehole.	
				<b>Toughness:</b> Low (L), Medium (M), High (H) <b>Plasticity:</b> Non-Plastic (NP), Low (L), Medium (M), High (H) <b>PP</b> = Pocket Penetrometer, measured in tons per square ft. <b>TV</b> = Torvane (Shear Vane), measured in tons per square ft.	



# Rock Coring Log

B-07

<b>Client:</b> Concept Engineering Consultants, PA	<b>Drilling Firm:</b> Boring Brothers, Inc	<b>Coordinates:</b> 40.64176389 N,-74.9069028 E
<b>Project:</b> Clinton Commons	<b>Drill Crew:</b> M. Daniel / D. Osuch	<b>Horiz. Datum:</b> WGS 84
<b>Location:</b> Clinton, NJ	<b>Boring Start:</b> 9/14/2022 1:00:00 PM	<b>Elevation:</b> Grade
<b>Inspector:</b> Sidharth Nambiar	<b>Boring End:</b> 9/14/2022 3:30:00 PM	<b>Vert. Datum:</b> N/A

<b>Rig Model:</b> CME-55LC	<b>Casing Type:</b> Steel Casing	<b>Core Barrel Type:</b> NQ	<b>Core Bit Type:</b> NQ - 01
<b>Rig Type:</b> Track	<b>Casing Length:</b> 5 feet	<b>Core Barrel Length:</b> 5 feet	<b>Core Bit Length:</b> 3 inches
<b>Drill Method:</b> Mud Rotary	<b>Casing I.D.:</b> 4 inches	<b>Core Barrel I.D.:</b> 3 inches	<b>Core Bit I.D.:</b> 1.875 inches

Depth (ft)	Avg Core Rate (min/ft)	Run No.	Recovery (in. / %)	RQD (in. / %)	Hardness	Weathering	Graphic Log	Visual Classification	Depth (ft.)	Discontinuities						Drilling & Strata Notes
										Type	Dip Angle	Roughness	Weathering	Aperture	Infilling	
2.48								LIMESTONE, light gray fine grained, slightly weathered, very close to close discontinuity spacing.								Casing installed at 5 feet BGS.
2.63								5' to 10' Fractured Zone.								
4.2		R-1	24 40%	0 0%	R3	SL										
4.13																
4.97																
10								LIMESTONE, light gray fine grained, slightly weathered, very close to close discontinuity spacing.								
3.93								10' to 15' Fractured Zone.								
5.18																
6.87		R-2	8 13%	0 0%												
5.7																
6.03																
15								End of Boring at 15 feet BGS. Backfilled with soil and bentonite holeplug.								

In-Borehole Water Levels				General Notes	
Date / Time	Casing Tip (ft)	Bot. of Hole (ft)	Water Lvl (ft)		
				▼ = Water Level (if observed)      BGS = Below Ground Surface Groundwater was not encountered within this borehole.	



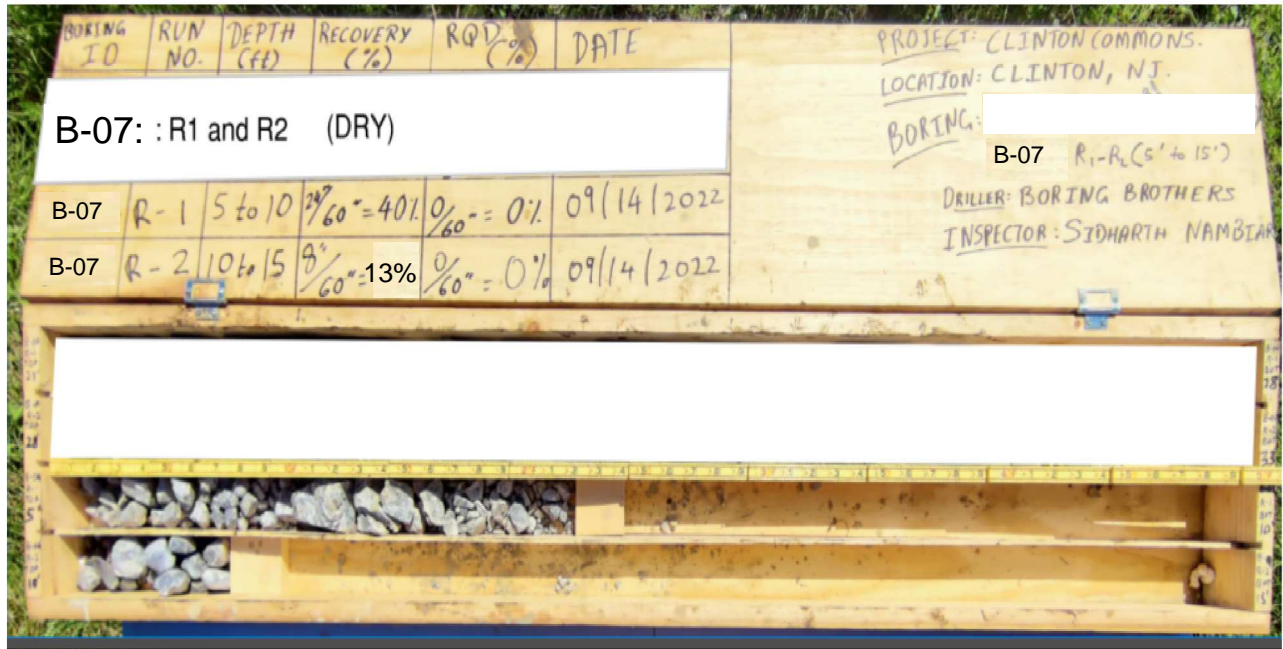


Figure B-07.1  
B-07; R-1 and R-2 (dry)

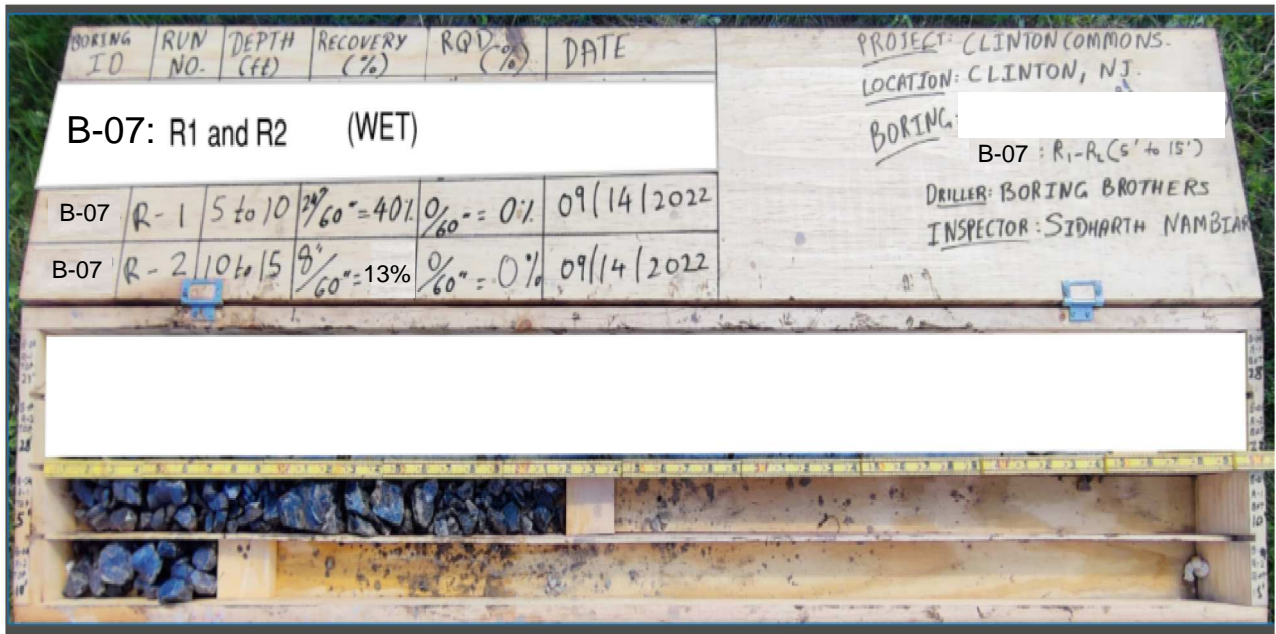


Figure B-07.2  
B-07; R-1 and R-2 (wet)



# Soil Boring Log

**B-08**

<b>Client:</b> Concept Engineering Consultants, PA	<b>Drilling Firm:</b> Boring Brothers, Inc	<b>Coordinates:</b> 40.642431 N, -74.905622 E
<b>Project:</b> Clinton Commons	<b>Drill Crew:</b> Rob Dollar / Lyle Delmeir	<b>Horiz. Datum:</b> NAD83
<b>Location:</b> Clinton, NJ	<b>Boring Start:</b> 5/11/2022 8:30:00 AM	<b>Elevation:</b> Grade
<b>Inspector:</b> Michael Garcia	<b>Boring End:</b> 5/11/2022 11:00:00 AM	<b>Vert. Datum:</b> N/A

<b>Rig Model:</b> CME-55LC	<b>Sampler Type:</b> Split Spoon	<b>Casing Type:</b> Steel Casing
<b>Rig Type:</b> Track	<b>Sampler Length:</b> 24 inches	<b>Casing Length:</b> 5 feet
<b>Drill Method:</b> Mud Rotary	<b>Sampler I.D.:</b> 1.375 inches	<b>Casing I.D.:</b> 4 inches
<b>Hammer Type:</b> Automatic	<b>Hammer Wt.:</b> 140 pounds	<b>Hammer Wt.:</b> 140 pounds
<b>Drilling Fluid:</b> Water	<b>Hammer Fall:</b> 30 inches	<b>Hammer Fall:</b> 30 inches

Depth (ft)	Sample No.	Rec. (ft)	Blows per 6"	N-Value	USCS Symbol	Graphic Log	Visual Classification	Toughness	Plasticity	PP (tsf)	TV (tsf)	N-Value				Drilling & Strata Notes
												10	20	30	40	
4	S-1	16	4 4 5 2	9	SP		Loose, light to darkish brown coarse to medium SAND, trace Silt, dry (SP)									
5	S-2	18	5 6 8 5	14			Medium dense, light brown coarse to medium SAND, trace Silt, dry (SP)									
5	S-3	16	10 15 52 38	> 50	GP		Very dense, light gray coarse to fine GRAVEL, some medium to fine Sand, trace Silt, dry (GP)									
5	S-4	15	20 31 54 58	> 50			Very dense, light gray coarse to fine GRAVEL, some medium to fine Sand, trace Silt, dry (GP)									
5	S-5	2.5	50/5"	> 50			Very dense, light gray coarse to fine GRAVEL, some medium to fine Sand, trace Silt, wet (GP)									
10							Coring Rock at 10 feet BGS See Rock Coring Log									
15																
20																

In-Borehole Water Levels				General Notes	
Date / Time	Casing Tip (ft)	Bot. of Hole (ft)	Water Lvl (ft)		
				▼ = Water Level (if observed) BGS = Below Ground Surface Groundwater was not encountered within this borehole.	
				<b>Toughness:</b> Low (L), Medium (M), High (H) <b>Plasticity:</b> Non-Plastic (NP), Low (L), Medium (M), High (H) <b>PP</b> = Pocket Penetrometer, measured in tons per square ft. <b>TV</b> = Torvane (Shear Vane), measured in tons per square ft.	



# Rock Coring Log

**B-08**

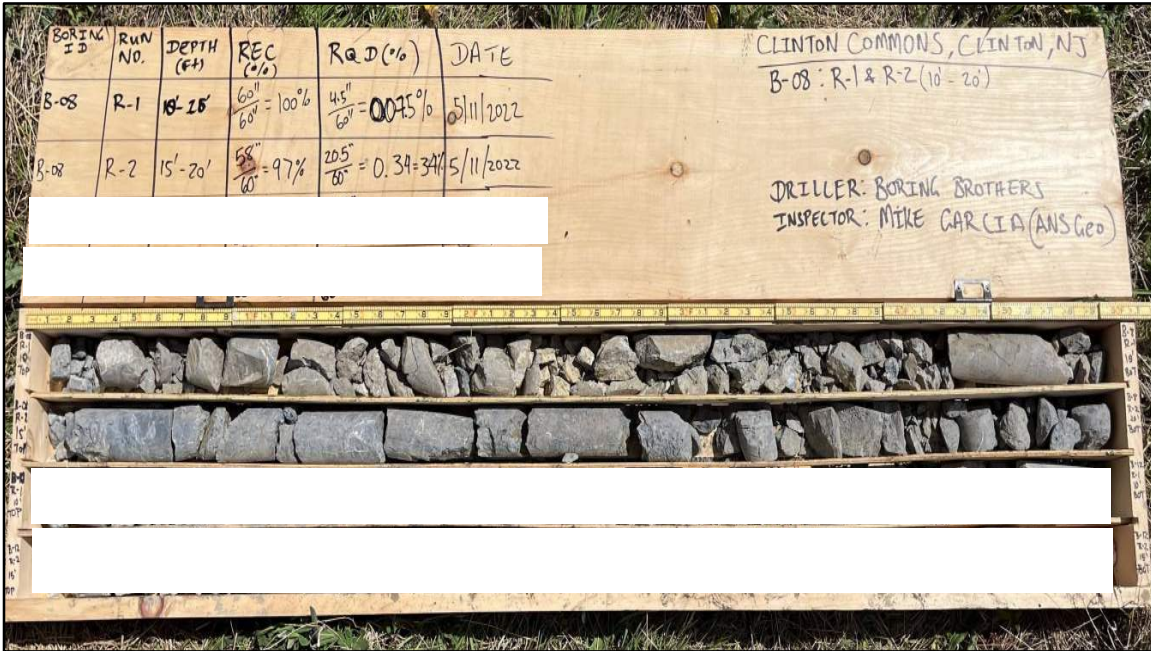
<b>Client:</b> Concept Engineering Consultants, PA	<b>Drilling Firm:</b> Boring Brothers, Inc	<b>Coordinates:</b> 40.642431 N, -74.905622 E
<b>Project:</b> Clinton Commons	<b>Drill Crew:</b> Rob Dollar / Lyle Delmeir	<b>Horiz. Datum:</b> NAD83
<b>Location:</b> Clinton, NJ	<b>Boring Start:</b> 5/11/2022 8:30:00 AM	<b>Elevation:</b> Grade
<b>Inspector:</b> Michael Garcia	<b>Boring End:</b> 5/11/2022 11:00:00 AM	<b>Vert. Datum:</b> N/A

<b>Rig Model:</b> CME-55LC	<b>Casing Type:</b> Steel Casing	<b>Core Barrel Type:</b> NQ	<b>Core Bit Type:</b> NQ - 01
<b>Rig Type:</b> Track	<b>Casing Length:</b> 5 feet	<b>Core Barrel Length:</b> 5 feet	<b>Core Bit Length:</b> 3 inches
<b>Drill Method:</b> Mud Rotary	<b>Casing I.D.:</b> 4 inches	<b>Core Barrel I.D.:</b> 3 inches	<b>Core Bit I.D.:</b> 1.875 inches

Depth (ft)	Avg Core Rate (min/ft)	Run No.	Recovery (in. / %)	RQD (in. / %)	Hardness	Weathering	Graphic Log	Visual Classification	Depth (ft.)	Discontinuities						Drilling & Strata Notes	
										Type	Dip Angle	Roughness	Weathering	Aperture	Infilling		
1.5								LIMESTONE, light to dark gray medium to fine grained, moderately weathered, medium strong, very close to close discontinuity spacing.  10' to 14.3' Fractured Rock.								Calcite veins throughout the cores. Water at 10 feet BGS and returned back at 18 feet BGS. Light gray return.	
2.63																	
3.67		R-1	60 100%	4.5 7.5%	R3	M			14.17	J	20	S,R	DS	T	N		
3.72																	
11.5																	
15								LIMESTONE, light to dark gray medium to fine grained, moderately weathered, medium strong, very close to close discontinuity spacing.  18' to 20' Fractured Rock.								Calcite veins throughout the cores. Gray water return.	
1.42									15.65	J	10	P,R	DS	T	N		
3.45									16.25	J	25	S,R	DS	T	N		
3.03		R-2	58 97%	21 35%	R3	M			17.35	J	44	S,R	DS	T	N		
3.58																	
7.58																	
20								End of Boring at 20 feet BGS. Backfilled with soil and bentonite holeplug.									
25																	

In-Borehole Water Levels				General Notes	
Date / Time	Casing Tip (ft)	Bot. of Hole (ft)	Water Lvl (ft)		
				▼ = Water Level (if observed)      BGS = Below Ground Surface Groundwater was not encountered within this borehole.	





**Figure B-08.1**  
B-08; R-1 and R-2 (dry)



**Figure B-08.2**  
B-08; R-1 and R-2 (wet)



# Soil Boring Log

**B-09**

<b>Client:</b> Concept Engineering Consultants, PA	<b>Drilling Firm:</b> Boring Brothers, Inc	<b>Coordinates:</b> 40.641261 N,-74.9068861 E
<b>Project:</b> Clinton Commons	<b>Drill Crew:</b> R. Dollar / L. Delmeir	<b>Horiz. Datum:</b> WGS 84
<b>Location:</b> Clinton, NJ	<b>Boring Start:</b> 9/20/2022 12:45:00 PM	<b>Elevation:</b> Grade
<b>Inspector:</b> Sidharth Nambiar	<b>Boring End:</b> 9/20/2022 2:10:00 PM	<b>Vert. Datum:</b> N/A

<b>Rig Model:</b> CME-55LC	<b>Sampler Type:</b> Split Spoon	<b>Casing Type:</b> Steel Casing
<b>Rig Type:</b> Track	<b>Sampler Length:</b> 24 inches	<b>Casing Length:</b> 5 feet
<b>Drill Method:</b> Mud Rotary	<b>Sampler I.D.:</b> 1.375 inches	<b>Casing I.D.:</b> 4 inches
<b>Hammer Type:</b> Automatic	<b>Hammer Wt.:</b> 140 pounds	<b>Hammer Wt.:</b> 140 pounds
<b>Drilling Fluid:</b> Water	<b>Hammer Fall:</b> 30 inches	<b>Hammer Fall:</b> 30 inches

Depth (ft)	Sample No.	Rec. (in)	Blows per 6"	N-Value	USCS Symbol	Graphic Log	Visual Classification	Toughness	Plasticity	PP (tsf)	TV (tsf)	N-Value				Drilling & Strata Notes
												10	20	30	40	
	S-1		7 35 45 50/3"	> 50	SM		Very dense, light brown to brown coarse to fine SAND, some Silt, little coarse to fine Gravel, dry, (SM)								>>	Casing installed at 2 feet BGS.
	S-2		50/0"	> 50			No recovery.									
5							Coring Rock at 3 feet BGS. See Rock Coring Log.									
10																
15																
20																

In-Borehole Water Levels				General Notes	
Date / Time	Casing Tip (ft)	Bot. of Hole (ft)	Water Lvl (ft)		
				▼ = Water Level (if observed) BGS = Below Ground Surface Groundwater was not encountered within this borehole.	
				<b>Toughness:</b> Low (L), Medium (M), High (H) <b>Plasticity:</b> Non-Plastic (NP), Low (L), Medium (M), High (H) <b>PP</b> = Pocket Penetrometer, measured in tons per square ft. <b>TV</b> = Torvane (Shear Vane), measured in tons per square ft.	





# Rock Coring Log

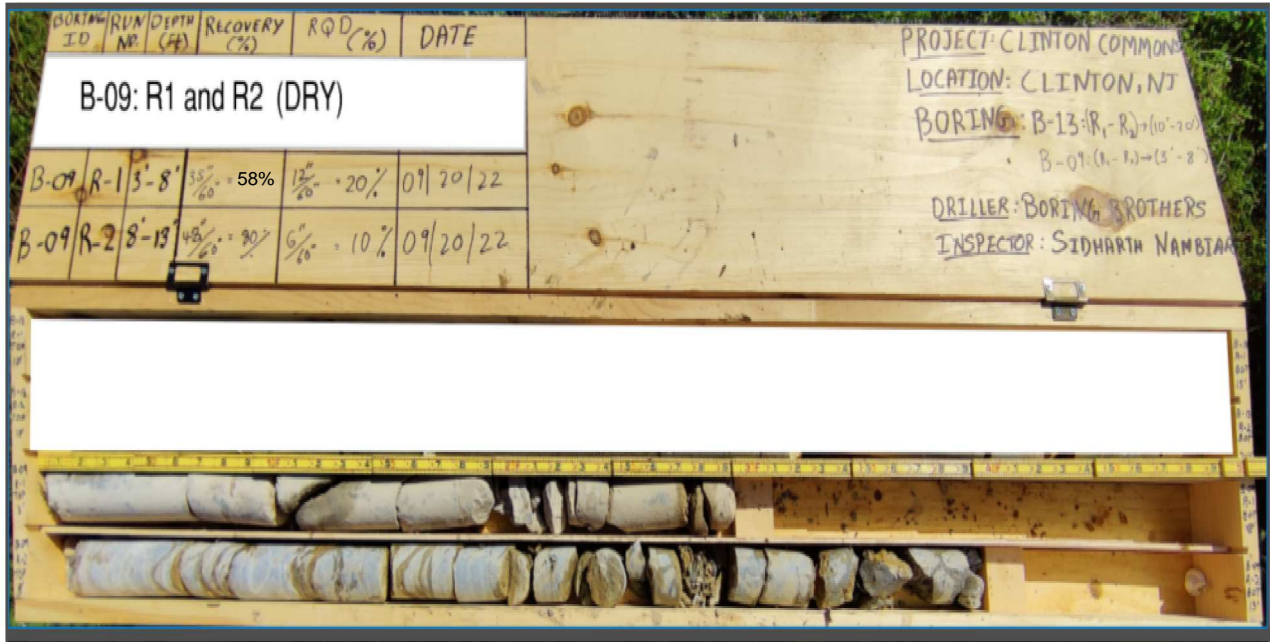
**B-09**

<b>Client:</b> Concept Engineering Consultants, PA	<b>Drilling Firm:</b> Boring Brothers, Inc	<b>Coordinates:</b> 40.641261 N,-74.9068861 E
<b>Project:</b> Clinton Commons	<b>Drill Crew:</b> R. Dollar / L. Delmeir	<b>Horiz. Datum:</b> WGS 84
<b>Location:</b> Clinton, NJ	<b>Boring Start:</b> 9/20/2022 12:45:00 PM	<b>Elevation:</b> Grade
<b>Inspector:</b> Sidharth Nambiar	<b>Boring End:</b> 9/20/2022 2:10:00 PM	<b>Vert. Datum:</b> N/A

<b>Rig Model:</b> CME-55LC	<b>Casing Type:</b> Steel Casing	<b>Core Barrel Type:</b> NQ	<b>Core Bit Type:</b> NQ - 01
<b>Rig Type:</b> Track	<b>Casing Length:</b> 5 feet	<b>Core Barrel Length:</b> 5 feet	<b>Core Bit Length:</b> 3 inches
<b>Drill Method:</b> Mud Rotary	<b>Casing I.D.:</b> 4 inches	<b>Core Barrel I.D.:</b> 3 inches	<b>Core Bit I.D.:</b> 1.875 inches

Depth (ft)	Avg Core Rate (min/ft)	Run No.	Recovery (in. / %)	RQD (in. / %)	Hardness	Weathering	Graphic Log	Visual Classification	Depth (ft.)	Discontinuities						Drilling & Strata Notes
										Type	Dip Angle	Roughness	Weathering	Aperture	Infilling	
3.1								LIMESTONE, light gray fine grained, slightly weathered, very close discontinuity spacing.	3.7	J	40	P,R	FR	VT	N	
1.68									4.5	J	55	P,R	FR	VT	N	
5		R-1	35 58%	12 20%	R3	SL		5.1' to 5.9' Fractured Zone.								
1.383																
2.25																
4.97																
10		R-2	48 80%	6 10%	R3	SL		LIMESTONE, light gray fine grained, slightly weathered, very close to close discontinuity spacing.  8.6' to 13' Fractured Zone.	8.6	J	30	P,R	DS	VT	N	
5.07																
2.17																
3.07																
3.75																
4.35																
15								End of Boring at 13 feet BGS. Backfilled with soil and bentonite holeplug.								

In-Borehole Water Levels				General Notes	
Date / Time	Casing Tip (ft)	Bot. of Hole (ft)	Water Lvl (ft)		
				▼ = Water Level (if observed)      BGS = Below Ground Surface Groundwater was not encountered within this borehole.	



**Figure B-09.1**  
B-09; R-1 and R-2 (dry)



**Figure B-09.2**  
B-09; R-1 and R-2 (wet)



# Soil Boring Log

**B-10**

<b>Client:</b> Concept Engineering Consultants, PA	<b>Drilling Firm:</b> Boring Brothers, Inc	<b>Coordinates:</b> 40.641403 N, -74.906431 E
<b>Project:</b> Clinton Commons	<b>Drill Crew:</b> Rob Dollar / Lyle Delmeir	<b>Horiz. Datum:</b> NAD83
<b>Location:</b> Clinton, NJ	<b>Boring Start:</b> 5/11/2022 1:00:00 PM	<b>Elevation:</b> Grade
<b>Inspector:</b> Michael Garcia	<b>Boring End:</b> 5/11/2022 2:30:00 PM	<b>Vert. Datum:</b> N/A

<b>Rig Model:</b> CME-55LC	<b>Sampler Type:</b> Split Spoon	<b>Casing Type:</b> Steel Casing
<b>Rig Type:</b> Track	<b>Sampler Length:</b> 24 inches	<b>Casing Length:</b> 5 feet
<b>Drill Method:</b> Mud Rotary	<b>Sampler I.D.:</b> 1.375 inches	<b>Casing I.D.:</b> 4 inches
<b>Hammer Type:</b> Automatic	<b>Hammer Wt.:</b> 140 pounds	<b>Hammer Wt.:</b> 140 pounds
<b>Drilling Fluid:</b> Water	<b>Hammer Fall:</b> 30 inches	<b>Hammer Fall:</b> 30 inches

Depth (ft)	Sample No.	Rec. (ft)	Blows per 6"	N-Value	USCS Symbol	Graphic Log	Visual Classification	Toughness	Plasticity	PP (tsf)	TV (tsf)	N-Value 10 20 30 40	Drilling & Strata Notes
	S-1	19	2 4 1 2	5	SC		Loose, light brown SAND, some Clay, trace Silt, moist (SC)						
	S-2	16	2 1 3 2	4	CL		Soft, light brown CLAY, some medium to fine Sand, trace Silt, moist (CL)						
5	S-3	10	4 4 3 1	7	SP		Loose, light gray to brown, [grain size] SAND, some [grain size] Gravel, trace Clay, trace Silt, moist (SP)						
	S-4	5	50/4"	> 50	GP		Very dense light gray coarse to fine GRAVEL, trace medium to fine Sand, trace Silt, trace Clay, moist (GP)						Casing installed to 7 feet BGS.
	S-5	3	50/1"	> 50			Very dense light gray coarse to fine GRAVEL, trace Silt, wet (GP)						Roller bit down to 8 feet BGS. Rig chatter from 8 to 9 feet BGS.
10	Coring Rock at 10 feet BGS See Rock Coring Log												Roller bit down to 10 feet BGS. Split spoon refusal at 10 feet BGS. Light gray water return. Roller bit refusal at 10 feet BGS.
15													
20													

In-Borehole Water Levels				General Notes	
Date / Time	Casing Tip (ft)	Bot. of Hole (ft)	Water Lvl (ft)		
				▼ = Water Level (if observed) BGS = Below Ground Surface Groundwater was not encountered within this borehole.	
				<b>Toughness:</b> Low (L), Medium (M), High (H) <b>Plasticity:</b> Non-Plastic (NP), Low (L), Medium (M), High (H) <b>PP</b> = Pocket Penetrometer, measured in tons per square ft. <b>TV</b> = Torvane (Shear Vane), measured in tons per square ft.	



# Rock Coring Log

**B-10**

<b>Client:</b> Concept Engineering Consultants, PA	<b>Drilling Firm:</b> Boring Brothers, Inc	<b>Coordinates:</b> 40.641403 N, -74.906431 E
<b>Project:</b> Clinton Commons	<b>Drill Crew:</b> Rob Dollar / Lyle Delmeir	<b>Horiz. Datum:</b> NAD83
<b>Location:</b> Clinton, NJ	<b>Boring Start:</b> 5/11/2022 1:00:00 PM	<b>Elevation:</b> Grade
<b>Inspector:</b> Michael Garcia	<b>Boring End:</b> 5/11/2022 2:30:00 PM	<b>Vert. Datum:</b> N/A

<b>Rig Model:</b> CME-55LC	<b>Casing Type:</b> Steel Casing	<b>Core Barrel Type:</b> NQ	<b>Core Bit Type:</b> NQ - 01
<b>Rig Type:</b> Track	<b>Casing Length:</b> 5 feet	<b>Core Barrel Length:</b> 5 feet	<b>Core Bit Length:</b> 3 inches
<b>Drill Method:</b> Mud Rotary	<b>Casing I.D.:</b> 4 inches	<b>Core Barrel I.D.:</b> 3 inches	<b>Core Bit I.D.:</b> 1.875 inches

Depth (ft)	Avg Core Rate (min/ft)	Run No.	Recovery (in. / %)	RQD (in. / %)	Hardness	Weathering	Graphic Log	Visual Classification	Depth (ft.)	Discontinuities						Drilling & Strata Notes
										Type	Dip Angle	Roughness	Weathering	Aperture	Infilling	
3.07								LIMESTONE, light gray, coarse to fine grained, moderately weathered, medium strong, very close to close discontinuity spacing.  11.8' Fractured Rock.	10.55	S	47	S,R	DS	T	N	Calcite veins throughout the cores. Return was light gray.
3.50							11.1		S	40	S,R	DS	T	N		
3.77	R-1	42 70%	16 27%	R3	M											
4.85																
5.17																
15								LIMESTONE, light gray, coarse to fine grained, moderately weathered, medium strong, very close to close discontinuity spacing.	15	S	35	S,R	DS	T	N	Calcite veins throughout the cores. Return was light gray.  Vertical fracture at 17.1 feet BGS.
3.40																
3.48																
3.58	R-2	58 97%	42 70%	R3	M											
5.36																
20								End of Boring at 20 feet BGS. Backfilled with soil and bentonite holeplug.	17.5	S	74	S,R	DS	T	N	
5.73									18.25	S	34	S,R	DS	T	N	
25																

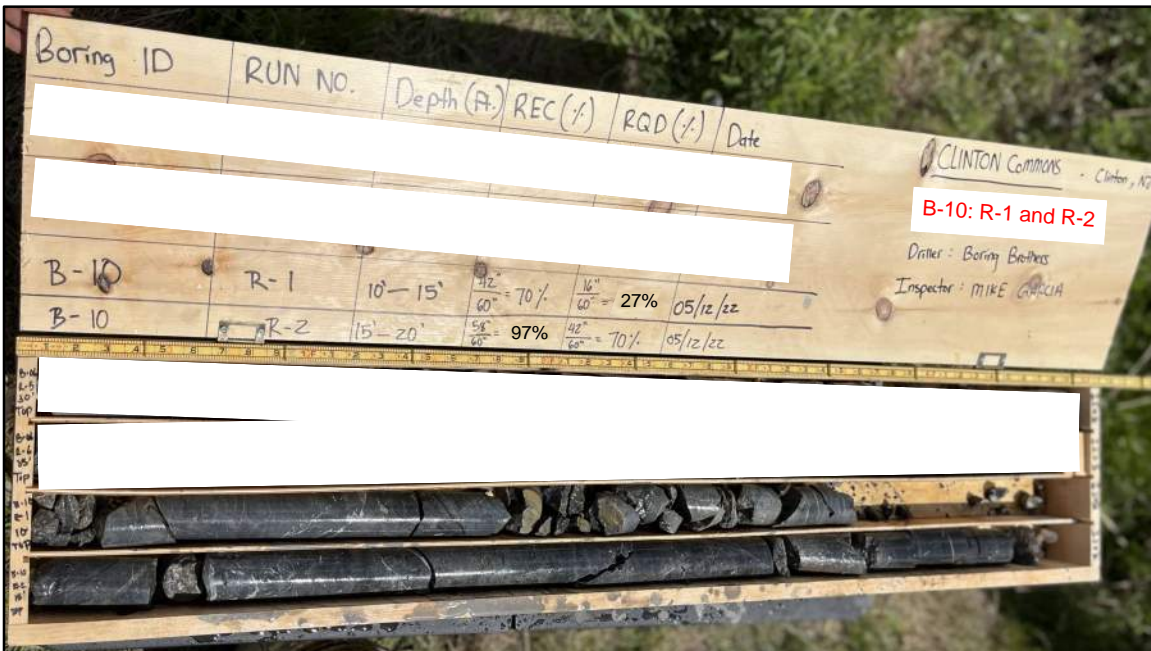
In-Borehole Water Levels				General Notes	
Date / Time	Casing Tip (ft)	Bot. of Hole (ft)	Water Lvl (ft)		
				▼ = Water Level (if observed)      BGS = Below Ground Surface Groundwater was not encountered within this borehole.	





**Figure B-10.1**

**B-10; R-1 and R-2 (dry)**



**Figure B-10.2**

**B-10; R-1 and R-2 (wet)**





# Soil Boring Log

**B-12**

<b>Client:</b> Concept Engineering Consultants, PA	<b>Drilling Firm:</b> Boring Brothers, Inc	<b>Coordinates:</b> 40.641903 N, -74.905997 E
<b>Project:</b> Clinton Commons	<b>Drill Crew:</b> Rob Dollar / Lyle Delmeir	<b>Horiz. Datum:</b> NAD83
<b>Location:</b> Clinton, NJ	<b>Boring Start:</b> 5/12/2022 11:15:00 AM	<b>Elevation:</b> Grade
<b>Inspector:</b> Michael Garcia	<b>Boring End:</b> 5/12/2022 2:30:00 PM	<b>Vert. Datum:</b> N/A

<b>Rig Model:</b> CME-55LC	<b>Sampler Type:</b> Split Spoon	<b>Casing Type:</b> Steel Casing
<b>Rig Type:</b> Track	<b>Sampler Length:</b> 24 inches	<b>Casing Length:</b> 5 feet
<b>Drill Method:</b> Mud Rotary	<b>Sampler I.D.:</b> 1.375 inches	<b>Casing I.D.:</b> 4 inches
<b>Hammer Type:</b> Automatic	<b>Hammer Wt.:</b> 140 pounds	<b>Hammer Wt.:</b> 140 pounds
<b>Drilling Fluid:</b> Water	<b>Hammer Fall:</b> 30 inches	<b>Hammer Fall:</b> 30 inches

Depth (ft)	Sample No.	Rec. (ft)	Blows per 6"	N-Value	USCS Symbol	Graphic Log	Visual Classification	Toughness	Plasticity	PP (tsf)	TV (tsf)	N-Value				Drilling & Strata Notes	
												10	20	30	40		
5	S-1	16	8 9 7 10	16	GP		Medium dense, light gray to brown coarse to fine GRAVEL, some fine Sand, trace Silt, dry (GP)										
	S-2	19	11 10 12 18	22			Medium dense, light gray to brown coarse to fine GRAVEL, some fine Sand, trace Silt, dry (GP)										
	S-3	20	11 14 21 34	35			Dense, light gray to brown coarse to fine GRAVEL, some fine Sand, trace Silt, dry (GP)										
	S-4	11	50/5"	> 50			Very dense, light gray coarse to fine GRAVEL, some fine Sand, trace Silt, dry (GP)										
	S-5	0	50/0"	> 50			Split Spoon refusal at 8 feet BGS.										
10							Coring Rock at 10 feet BGS See Rock Coring Log										
15																	
20																	

In-Borehole Water Levels				General Notes	
Date / Time	Casing Tip (ft)	Bot. of Hole (ft)	Water Lvl (ft)		
				▼ = Water Level (if observed) BGS = Below Ground Surface Groundwater was not encountered within this borehole.	
				<b>Toughness:</b> Low (L), Medium (M), High (H) <b>Plasticity:</b> Non-Plastic (NP), Low (L), Medium (M), High (H) <b>PP</b> = Pocket Penetrometer, measured in tons per square ft. <b>TV</b> = Torvane (Shear Vane), measured in tons per square ft.	



# Rock Coring Log

B-12

<b>Client:</b> Concept Engineering Consultants, PA	<b>Drilling Firm:</b> Boring Brothers, Inc	<b>Coordinates:</b> 40.641903 N, -74.905997 E
<b>Project:</b> Clinton Commons	<b>Drill Crew:</b> Rob Dollar / Lyle Delmeir	<b>Horiz. Datum:</b> NAD83
<b>Location:</b> Clinton, NJ	<b>Boring Start:</b> 5/12/2022 11:15:00 AM	<b>Elevation:</b> Grade
<b>Inspector:</b> Michael Garcia	<b>Boring End:</b> 5/12/2022 2:30:00 PM	<b>Vert. Datum:</b> N/A

<b>Rig Model:</b> CME-55LC	<b>Casing Type:</b> Steel Casing	<b>Core Barrel Type:</b> NQ	<b>Core Bit Type:</b> NQ - 01
<b>Rig Type:</b> Track	<b>Casing Length:</b> 5 feet	<b>Core Barrel Length:</b> 5 feet	<b>Core Bit Length:</b> 3 inches
<b>Drill Method:</b> Mud Rotary	<b>Casing I.D.:</b> 4 inches	<b>Core Barrel I.D.:</b> 3 inches	<b>Core Bit I.D.:</b> 1.875 inches

Depth (ft)	Avg Core Rate (min/ft)	Run No.	Recovery (in. / %)	RQD (in. / %)	Hardness	Weathering	Graphic Log	Visual Classification	Depth (ft.)	Discontinuities						Drilling & Strata Notes	
										Type	Dip Angle	Roughness	Weathering	Aperture	Infilling		
6.17								LIMESTONE, light gray, coarse to fine grained, moderately weathered, medium strong, very close to close discontinuity spacing.	10.8	J	41	S,R	DS	T	N	Calcite veins throughout the cores. Vertical fracture at 11.5 feet BGS. Light gray return.	
10.50								10' to 12.3' Fractured Rock.	12.2	J	35	S,R	DS	T	N		
5.83	R-1	43 72%	17 28%	R3	M				13	J	44	S,R	DS	T	N		
9.50																	
9.00																	
15								LIMESTONE, light gray, coarse to fine grained, moderately weathered, medium strong, very close to close discontinuity spacing.								Calcite veins throughout the cores. Light gray return.	
5.43								Fractured Rock.									
11.15																	
6.28	R-2	40 67%	5 8%	R3	M				17.7	J	10	S,R	DS	T	N		
7.77																	
20																	
6.33								End of Boring at 20 feet BGS. Backfilled with soil and bentonite holeplug.									

In-Borehole Water Levels				General Notes	
Date / Time	Casing Tip (ft)	Bot. of Hole (ft)	Water Lvl (ft)		
				▼ = Water Level (if observed)      BGS = Below Ground Surface Groundwater was not encountered within this borehole.	



Figure B-12.1

B-12; R-1 and R-2 (dry)

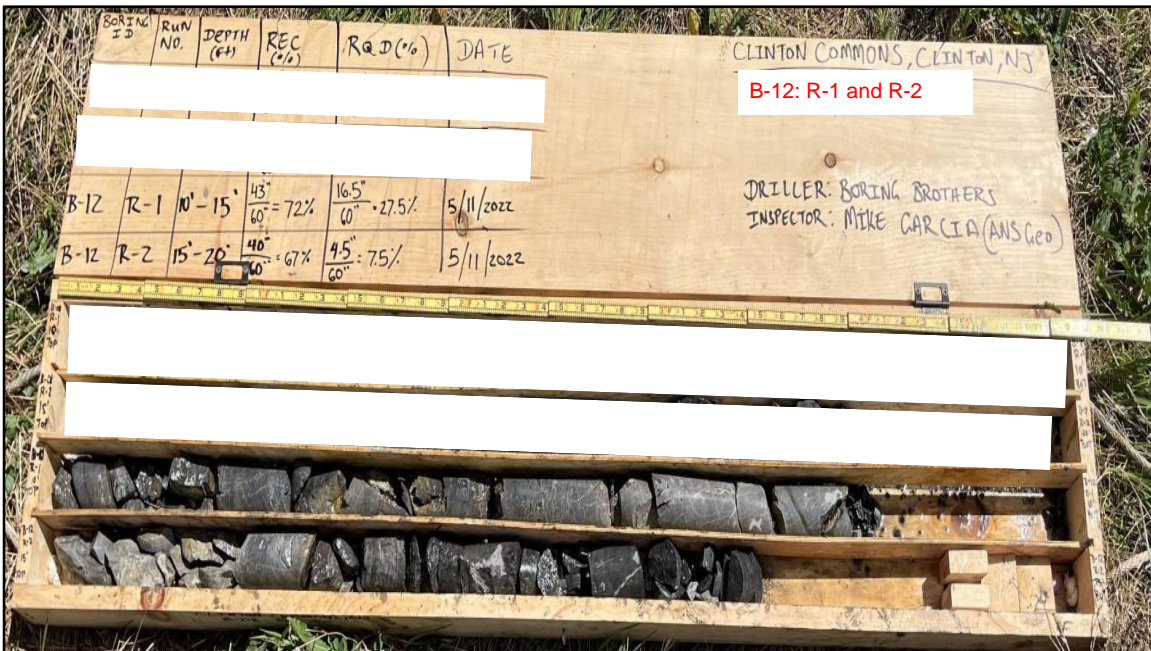


Figure B-12.2

B-12; R-1 and R-2 (wet)



# Soil Boring Log

**B-13**

<b>Client:</b> Concept Engineering Consultants, PA	<b>Drilling Firm:</b> Boring Brothers, Inc	<b>Coordinates:</b> 40.64118056 N,-74.9077639 E
<b>Project:</b> Clinton Commons	<b>Drill Crew:</b> R. Dollar / L. Delmeir	<b>Horiz. Datum:</b> WGS 84
<b>Location:</b> Clinton, NJ	<b>Boring Start:</b> 9/20/2022 9:00:00 AM	<b>Elevation:</b> Grade
<b>Inspector:</b> Sidharth Nambiar	<b>Boring End:</b> 9/20/2022 12:30:00 PM	<b>Vert. Datum:</b> N/A

<b>Rig Model:</b> CME-55LC	<b>Sampler Type:</b> Split Spoon	<b>Casing Type:</b> Steel Casing
<b>Rig Type:</b> Track	<b>Sampler Length:</b> 24 inches	<b>Casing Length:</b> 5 feet
<b>Drill Method:</b> Mud Rotary	<b>Sampler I.D.:</b> 1.375 inches	<b>Casing I.D.:</b> 4 inches
<b>Hammer Type:</b> Automatic	<b>Hammer Wt.:</b> 140 pounds	<b>Hammer Wt.:</b> 140 pounds
<b>Drilling Fluid:</b> Water	<b>Hammer Fall:</b> 30 inches	<b>Hammer Fall:</b> 30 inches

Depth (ft)	Sample No.	Rec. (in)	Blows per 6"	N-Value	USCS Symbol	Graphic Log	Visual Classification	Toughness	Plasticity	PP (tsf)	TV (tsf)	N-Value				Drilling & Strata Notes		
												10	20	30	40			
	S-1	10	2 2 1 1	3	ML		Soft, dark brown to light gray SILT, little coarse to fine Sand, little Clay, trace coarse to fine Gravel, dry (ML)	L	L	1.5	1.0					Weight of hammer penetrated first 12 inches. Very soft Soil.		
	S-2	12	0 0 1 11				Very soft, dark brown SILT, some coarse to fine Sand, little Clay, trace coarse to fine Gravel, dry (ML)	L	M	1.5	1.5							
5	S-3	9	42 25 20 8	45	GM		Dense, light gray to dark brown Silty coarse to fine GRAVEL, some coarse to fine Sand, dry (GM)										5	
	S-4	12	14 46 50 50/3"	> 50	GP		Very dense, light gray Sandy coarse to fine GRAVEL, little Silt, dry (GP)											
	S-5	0	50/0"	> 50			No recovery.											
10	Coring Rock at 10 feet BGS. See Rock Coring Log.																	10
15																		15
20																		20

In-Borehole Water Levels				General Notes	
Date / Time	Casing Tip (ft)	Bot. of Hole (ft)	Water Lvl (ft)		
				▼ = Water Level (if observed) BGS = Below Ground Surface Groundwater was not encountered within this borehole.	
				<b>Toughness:</b> Low (L), Medium (M), High (H) <b>Plasticity:</b> Non-Plastic (NP), Low (L), Medium (M), High (H) <b>PP</b> = Pocket Penetrometer, measured in tons per square ft. <b>TV</b> = Torvane (Shear Vane), measured in tons per square ft.	

<b>Client:</b> Concept Engineering Consultants, PA	<b>Drilling Firm:</b> Boring Brothers, Inc	<b>Coordinates:</b> 40.64118056 N,-74.9077639 E
<b>Project:</b> Clinton Commons	<b>Drill Crew:</b> R. Dollar / L. Delmeir	<b>Horiz. Datum:</b> WGS 84
<b>Location:</b> Clinton, NJ	<b>Boring Start:</b> 9/20/2022 9:00:00 AM	<b>Elevation:</b> Grade
<b>Inspector:</b> Sidharth Nambiar	<b>Boring End:</b> 9/20/2022 12:30:00 PM	<b>Vert. Datum:</b> N/A

<b>Rig Model:</b> CME-55LC	<b>Casing Type:</b> Steel Casing	<b>Core Barrel Type:</b> NQ	<b>Core Bit Type:</b> NQ - 01
<b>Rig Type:</b> Track	<b>Casing Length:</b> 5 feet	<b>Core Barrel Length:</b> 5 feet	<b>Core Bit Length:</b> 3 inches
<b>Drill Method:</b> Mud Rotary	<b>Casing I.D.:</b> 4 inches	<b>Core Barrel I.D.:</b> 3 inches	<b>Core Bit I.D.:</b> 1.875 inches

Depth (ft)	Avg Core Rate (min/ft)	Run No.	Recovery (in. / %)	RQD (in. / %)	Hardness	Weathering	Graphic Log	Visual Classification	Depth (ft.)	Discontinuities						Drilling & Strata Notes	
										Type	Dip Angle	Roughness	Weathering	Aperture	Infilling		
1.93								LIMESTONE, light gray fine grained, slightly weathered, very close discontinuity spacing.	10.8	J	50	P,R	FR	VT	N	Water loss encountered.	
1.6								10' to 15' Fractured Zone.									
4.95		R-1	28 47%	5 8%	R4	SL											
7.12																	
2.37																	
15								LIMESTONE, light gray fine grained, moderately weathered, very close discontinuity spacing.	16.2	J	30	P,R	FR	VT	N		
2.07								End of Boring at 20 feet BGS. Backfilled with soil and bentonite holeplug.									
2.23																	
1.95		R-2	57 95%	43 72%		M			17.6	J	40	P,R	DS	VT	N		
1.87									19	J	30	P,R	DS	T	N		
1.38									19.8	J	30	P,R	DS	T	N		
20																	
25																	

In-Borehole Water Levels				General Notes	
Date / Time	Casing Tip (ft)	Bot. of Hole (ft)	Water Lvl (ft)		
				▼ = Water Level (if observed)      BGS = Below Ground Surface Groundwater was not encountered within this borehole.	





**Figure B-13.1**  
B-13; R-1 and R-2 (dry)



**Figure B-13.2**  
B-13; R-1 and R-2 (wet)



# Soil Boring Log

**B-15**

<b>Client:</b> Concept Engineering Consultants, PA	<b>Drilling Firm:</b> Boring Brothers, Inc	<b>Coordinates:</b> 40.640653 N, -74.906947 E
<b>Project:</b> Clinton Commons	<b>Drill Crew:</b> Rob Dollar / Lyle Delmeir	<b>Horiz. Datum:</b> NAD83
<b>Location:</b> Clinton, NJ	<b>Boring Start:</b> 5/13/2022 8:15:00 AM	<b>Elevation:</b> Grade
<b>Inspector:</b> Michael Garcia	<b>Boring End:</b> 5/13/2022 11:45:00 AM	<b>Vert. Datum:</b> N/A

<b>Rig Model:</b> CME-55LC	<b>Sampler Type:</b> Split Spoon	<b>Casing Type:</b> Steel Casing
<b>Rig Type:</b> Track	<b>Sampler Length:</b> 24 inches	<b>Casing Length:</b> 5 feet
<b>Drill Method:</b> Mud Rotary	<b>Sampler I.D.:</b> 1.375 inches	<b>Casing I.D.:</b> 4 inches
<b>Hammer Type:</b> Automatic	<b>Hammer Wt.:</b> 140 pounds	<b>Hammer Wt.:</b> 140 pounds
<b>Drilling Fluid:</b> Water	<b>Hammer Fall:</b> 30 inches	<b>Hammer Fall:</b> 30 inches

Depth (ft)	Sample No.	Rec. (ft)	Blows per 6"	N-Value	USCS Symbol	Graphic Log	Visual Classification	Toughness	Plasticity	PP (tsf)	TV (tsf)	N-Value				Drilling & Strata Notes
												10	20	30	40	
	S-1	16	6 7 8 4	15	SP		Medium dense, light brown coarse to fine SAND, some coarse to fine Gravel, trace Silt, dry (SP)									Split spoon refusal at 3.25 feet BGS. Light gray water return. Roller bit refusal at 4 feet BGS.
	S-2	15	11 20 50/3"	> 50			Dense, light gray to brown medium to fine SAND, some coarse to fine Gravel, trace Silt, dry (SP)									
5							Coring Rock at 4 feet BGS See Rock Coring Log									
10																
15																
20																

In-Borehole Water Levels				General Notes	
Date / Time	Casing Tip (ft)	Bot. of Hole (ft)	Water Lvl (ft)		
				▼ = Water Level (if observed) BGS = Below Ground Surface Groundwater was not encountered within this borehole.	
				<b>Toughness:</b> Low (L), Medium (M), High (H) <b>Plasticity:</b> Non-Plastic (NP), Low (L), Medium (M), High (H) <b>PP</b> = Pocket Penetrometer, measured in tons per square ft. <b>TV</b> = Torvane (Shear Vane), measured in tons per square ft.	



# Rock Coring Log

**B-15**

<b>Client:</b> Concept Engineering Consultants, PA	<b>Drilling Firm:</b> Boring Brothers, Inc	<b>Coordinates:</b> 40.640653 N, -74.906947 E
<b>Project:</b> Clinton Commons	<b>Drill Crew:</b> Rob Dollar / Lyle Delmeir	<b>Horiz. Datum:</b> NAD83
<b>Location:</b> Clinton, NJ	<b>Boring Start:</b> 5/13/2022 8:15:00 AM	<b>Elevation:</b> Grade
<b>Inspector:</b> Michael Garcia	<b>Boring End:</b> 5/13/2022 11:45:00 AM	<b>Vert. Datum:</b> N/A

<b>Rig Model:</b> CME-55LC	<b>Casing Type:</b> Steel Casing	<b>Core Barrel Type:</b> NQ	<b>Core Bit Type:</b> NQ - 01
<b>Rig Type:</b> Track	<b>Casing Length:</b> 5 feet	<b>Core Barrel Length:</b> 5 feet	<b>Core Bit Length:</b> 3 inches
<b>Drill Method:</b> Mud Rotary	<b>Casing I.D.:</b> 4 inches	<b>Core Barrel I.D.:</b> 3 inches	<b>Core Bit I.D.:</b> 1.875 inches

Depth (ft)	Avg Core Rate (min/ft)	Run No.	Recovery (in. / %)	RQD (in. / %)	Hardness	Weathering	Graphic Log	Visual Classification	Depth (ft.)	Discontinuities						Drilling & Strata Notes	
										Type	Dip Angle	Roughness	Weathering	Aperture	Infilling		
5	5.25	R-1	43 72%	19 32%	R3	M		LIMESTONE, light gray coarse to fine grained, moderately weathered, medium strong, very close discontinuity spacing.	4.51	J	85	S,R	DS	T	N	Calcite veins throughout the cores. Light gray return. Vertical fracture at 6.1 feet BGS.	
	4.08								5.7	J	30	S,R	DS	T	N		
	5.33								6.1	J	60	S,R	DS	T	N		
	5.25																
	4.90																
10	4.72	R-2	44 73%	5 8%	R3	M	LIMESTONE, light gray coarse to fine grained, moderately weathered, medium strong, very close discontinuity spacing.	10.25	J	64	P,R	DS	T	N	Calcite veins throughout the cores. Light gray return. Vertical fracture at 11.7 feet BGS.		
5.03																	
4.85																	
5.70																	
5.52																	
15							End of Boring at 14 feet BGS. Backfilled with soil and bentonite holeplug.										

In-Borehole Water Levels				General Notes	
Date / Time	Casing Tip (ft)	Bot. of Hole (ft)	Water Lvl (ft)		
				▼ = Water Level (if observed)      BGS = Below Ground Surface Groundwater was not encountered within this borehole.	





**Figure B-15.1**  
B-15; R-1 and R-2 (dry)



**Figure B-15.2**  
B-15; R-1 and R-2 (wet)

## Appendix H

### **ANS Geo Karst Mitigation Plan**





# **KARST MANAGEMENT AND MITIGATION PLAN**

**Concept Engineering Consultants**

**Clinton Commons Project**  
Clinton, Hunterdon County, NJ

**October 30, 2023**

Prepared by: Vatsal A. Shah, PE, Ph. D, D.GE  
[Vatsal.Shah@ansgeo.com](mailto:Vatsal.Shah@ansgeo.com)

# Table of Contents

1. Introduction .....	1
2. Background .....	1
3. Potential Karst Risks Associated with Suburban Development Areas .....	2
4. Avoidance, Minimization, Management, and Mitigation Measures .....	2
5. Best Management Practices and Construction Housekeeping .....	3
6. Maintaining Buffer Areas and Other Construction Considerations .....	4
7. Equipment Storage, Fueling, and Maintenance Considerations .....	5
8. Construction-Phase Karst Inspections .....	5
9. Mitigation Measurements for Karst Encountered During Construction .....	6
10. References .....	7

**Attachments:**

- Attachment 1 – Sinkhole Repair with Pervious Cover Detail
- Attachment 2 – USDA NRCS Sinkhole Repair with Soil Cover Detail



## 1. Introduction

ANS Geo has provided this Karst Management and Mitigation Plan to provide recommendations related to karst, in the event it is identified during the construction of the Clinton Commons Project. Based on ANS Geo's understanding, the development area will consist of 14 structures including:

- Food Market (22,000 square feet)
- Convenience Store with a gas station (5,700 square feet)
- Restaurant Building (2,600 square feet)
- One Residential Building (3,760 square feet)
- Four Residential Buildings (5,000 square feet each)
- Five residential Buildings (7,500 square feet each)
- One residential Building (8,750 square feet)

The Plan outlines monitoring activities and the corrective measures that Concept Engineering Consultants may implement if karst features are encountered during the various stages of construction and long-term operation and maintenance of the development.

## 2. Background

Karst terrain is formed by the solution of carbonate rock (e.g., limestone, dolostone, and marble) by infiltrating surface water and groundwater along fractures, joints, and bedding planes. Karst terrain may be characterized by features such as cavern openings, sinkholes, closed depressions, and gaining and losing streams. When rock dissolves, spaces and caverns develop underground. These types of formations are referred to as karst topography. The land over these caverns may stay intact until there is not enough support for the land above the open space. Eventually, a collapse of the land can occur, creating a sinkhole, which can vary greatly in size and shape. Human activities and development can also expedite cavity formation in more susceptible materials and trigger a collapse.

Sinkholes are naturally occurring phenomena in areas underlain by carbonate bedrock. Most sinkholes are triggered by external factors such as significant or prolonged rainfall, periods of drought, heavy groundwater pumping, or stormwater management practices; however, activity at remnant or dormant sinkholes may be triggered by uncontrolled construction practices. When sinkholes (and associated ground movement) occur on urban developments, they generally express themselves at the ground surface in two ways: the first, as a collapse caused by exceeding the capacity of bridging support which exists above an air-filled void; and the second, a longer-duration and gradual ground surface movement as surface and subsurface soils are washed into cavities and karst features by groundwater movement. ANS Geo did not identify the presence of air-filled voids across the project site; and, observed that the predominant karst condition was pinnacled rock, soil-filled epi-karst, and highly weathered rock. ANS Geo notes that our findings are based on the focused locations where investigations were completed; and, while we expect the risk of karst to be low at this site, it is still possible that smaller features are identified during construction.

Karst is frequently a complex system impacted by groundwater flow direction, infiltration and precipitation, changes in landform and topography, as well as man-made development. A change

in any of these conditions, such as re-grading and re-direction of quantity, drainage, and infiltration of stormwater, can result in a change in the risk profile for areas across the site. Off-site impacts, such as groundwater pumping or increased infiltration caused by storm events can also alter the groundwater flow direction which can modify subsurface conditions.

In absence of the residential and commercial development, the risk of sinkhole and hydrologic-related phenomena occurring at the Project Site would continue to exist. Therefore, the intent of karst management and mitigation is generally toward avoidance of karst areas during initial planning and design by use of adequate buffer distances and focusing design toward non-karst areas. If it is not possible to avoid karst features due to land boundaries, available project area, or other environmental or engineering constraints, then minimization and mitigation of karst-related risks should be implemented.

### **3. Potential Karst Risks Associated with Suburban Development Areas**

Suburban Development Areas may span several geologic formations and soil types due to the nature of their size. As karst terrain has been identified, these formations have the ability to impact the foundations of the project in both the short-term and long-term, including:

1. Differential settlement across foundations, causing damage to structures.
2. Additional loads and stresses on structural elements;
3. Change in drainage patterns across the site, on-site and off-site hydrology, and run-off;
4. Development of topographic depressions which may hold water; and,
5. Settlement and serviceability concerns to foundations.

In general, the Clinton Commons project is expected to maintain the general topography and site coverage to the extent possible. Townhome and commercial construction typically consist of the project area being cleared and/or graded, with the exception of culturally and biologically sensitive areas.

Following clearing and grading, the proposed structures are expected to be supported by column and strip footings, which are expected to bear at a depth of 4 feet below ground surface. In areas of existing and mapped sinkholes, where the site grade will be *lower* than the surrounding site grade, structural fill may be required prior to setting the foundation.

### **4. Avoidance, Minimization, Management, and Mitigation Measures**

Avoidance of karst features is generally the primary mitigation measure during planning, design, and construction of the proposed project. During the various stages of project development, review of publicly available data along with site-specific geotechnical investigation results help determine the presence or absence of sinkholes for the Project. Once the potential for karst has been determined, development and site layout can consider these features into planning, construction, and operation.

In general, the karst avoidance areas are set to maintain a 50-foot buffer from the edge of a closed depression, subsidence feature, disappearing stream, or other karst sign. In cases where observations indicated sinkholes with open throats, apparent more recent subsidence shallow bedrock, and voids encountered by drilling, the buffer distance is typically increased to 100 feet. Since the design of the development has already been completed, avoidance measures may not be possible; therefore minimization, management, and mitigation measures will likely be necessary to maintain the project development.

For small, localized depressions, it is expected that remediation will require select excavation to identify and confirm the location of the sinkhole throat, placing geotextile separation and filter fabric across the entire bottom and sidewalls of the excavation, backfilling any identified cavern or open cavity with large-diameter stone or fill, then re-placement with a soil cap compacted to match native soil.

For large, bowl-like depressions, it is expected that the method of restoration and repair will be similar to the small sinkholes, along with mass filling to restore the site grade. It will be important that the material within these large basins is not simply placed in an uncontrolled manner, but placed in controlled lifts and compacted to a minimum of 90% of the fill material's Standard Proctor maximum dry density determined in accordance with ASTM D698. This will allow for shallow foundations such as wall, column and mat footings to have the intended structural capacity to support design loads. In areas where sinkholes are discovered within a proposed building's footprint, this compaction should be increased to a minimum of 95% Standard Proctor.

## **5. Best Management Practices and Construction Housekeeping**

Naturally occurring karst terrain provides a subsurface drainage system for overburden soil overlaying carbonate bedrock. However, concentrations of post-development stormwater runoff from construction activities can destabilize the natural karst hydrogeologic system and lead to potential sinkhole development, sinkhole flooding, or groundwater impacts if unmanaged.

The principal approach to avoid aggravating dormant caverns or possible areas of subsidence and karst activity is to maintain rates of recharge and discharge in the subsurface at the desired natural levels. In this context, desired natural levels refer to the pre-development recharge and discharge rates. Therefore, during construction and in areas where mapped and verified karst terrain exists, in addition to the standard erosion control Best Management Practices as defined in the project Stormwater Management Maintenance Plan (SWMM), double layers of silt fencing should be implemented, as well as hay bales or coir logs along the edges of active and un-remediated sinkhole areas to prevent outward migration of silt and reduce runoff velocity and water quantity into these sinkhole areas. This will help control the flow of water into underlying karst areas, which meets the intent of maintaining rates of subsurface recharge and discharge to pre-development conditions to minimize aggravating the karst condition.

Stormwater control measures in areas of known and verified karst terrain should also be enhanced to include detention and diversion to prevent construction-influenced stormwater from flowing to the karst feature drainage point. **NO CONSTRUCTION RUN-OFF SHOULD BE DIRECTED TO IDENTIFIED SINKHOLE AREAS.**



## 6. Maintaining Buffer Areas and Other Construction Considerations

It is understood that buffers around karst features generally have the intention of maintaining vegetation, structural integrity, or drainage of the existing karst feature within the buffer area. The use of buffers also helps minimize exposure to sinkhole subsidence and sinkhole flooding, if project features or components are proposed near or adjacent to these buffer areas. Buffers related to certain activities within karst areas are recommended as follows:

### **Earthmoving:**

During conventional installation of shallow foundations, slabs, and other accessory features, Concept Engineering Consultants or its subcontractor will conduct earthmoving activities. Where a known and delineated karst feature exists, earthmoving including permanent filling within 100 feet of the feature should be avoided to the extent possible, or minimized.

During routine trenching and utility/cabling installation adjacent to karst features, spoils should be placed on the upgradient side of the excavation such that, if any erosion was to occur, the stockpiled soil would return into the excavation and not to the downgradient to any documented karst features.

### **Removal of Rock:**

The Natural Resources Conservation Service (NRCS) defines shallow depth to bedrock as being within 5 feet of the ground surface. Should rock removal be deemed necessary, it may be removed using one of the following techniques, typically in the order listed below:

- a. Conventional excavation with a backhoe, along with line-drilling and splitting.
- b. Hammering with a pointed backhoe attachment or a pneumatic rock hammer, followed by backhoe excavation.
- c. Ripping with a bulldozer.

The rock removal technique should depend on rock properties, such as relative hardness, fracture susceptibility, expected volume, and location. Areas of shallow depth to bedrock crossed by the Project should be determined by review and analysis of published soil survey data from the National Resources Conservation Service (NRCS) Web Soil Survey, published geologic mapping, and site-specific investigations conducted across the project area.

Notwithstanding the above, rock removal in proximity to known and verified karst areas should be conducted in a manner so as not to compromise the structural integrity of pre-existing karst features or to alter subsurface hydrology through karst areas. If it is deemed that rock removal using hammering techniques is required in a karst-prone area, the area should be carefully inspected by a geotechnical representative from ANS Geo or other experienced geotechnical professional to evaluate if any voids, opening, or other identifying features typical of solution activity are present. If the proposed rock removal is expected to intersect a karst feature such as sinkhole throat/void, cavern, or conduit, work in the area will be stopped until a location-specific assessment can be made by ANS Geo or a qualified geotechnical engineer familiar with the project and with experience in karst terrain mitigation.

### **Construction Near Wells, Springs, and Karst Surface Expressions:**

Buffers of 100 feet around field-documented karst surface expressions and wells and springs recharging karst hydrology are recommended to be maintained between all work areas and the karst-related features. Surface water control measures including, but not limited to, diversion, detention, or collection and transportation should be implemented to minimize construction-influenced surface water from entering into the karst-related features. At no time should the karst features be used for the disposal or extraction of construction water.

## **7. Equipment Storage, Fueling, and Maintenance Considerations**

During construction activities, Concept Engineering Consultants and its subcontractor should implement best management practices to minimize the potential impact of spills related to equipment storage, fueling, and maintenance within proximity to karst areas and sensitive resources.

In general, refueling of vehicles should not occur within 200 feet of any karst feature open to the surface. Additionally, equipment refueling should not be performed within flagged or marked buffer areas of streambeds, sinkholes, fissures, or areas draining into these or other karst features, except by hand-carried cans (five-gallon maximum capacity) and when deemed necessary. For equipment servicing and maintenance activities, areas should be sited outside of flagged or marked buffer areas of streambeds, sinkholes, fissures, or areas draining into these or other karst features. Concept Engineering Consultants should instruct its subcontractor to avoid runoff created by equipment washing to directly enter any karst feature by locating these features outside the buffer areas listed in Section 6.

To the extent practical, no equipment or material should be stored within proximity of exposed karst features. Where storage is necessary near known karst areas, any construction equipment vehicles, materials, hazardous materials, chemicals, fuels, lubricating oils, and petroleum products should not be parked, stored, or serviced within 300 feet of any karst feature. Should equipment require storage within this buffer area, the equipment should be checked daily for leaks by a construction inspector familiar with operation and maintenance of the specific equipment. Any damaged, defective, or leaky equipment should be removed and replaced.

## **8. Construction-Phase Karst Inspections**

Prior to and throughout construction, on sites where karst has been positively identified, Concept Engineering Consultants or its subcontractor should conduct awareness training for karst-like features such as portals, voids, or sinkholes. The training should include the Contractor's field supervisory personnel and supervisory personnel. These personnel should be trained on potential unanticipated karst features (i.e. features not identified through previous geophysical mapping and historic records) that could be discovered during trenching operations. The training should also provide the appropriate protocol for work stoppage if a karst feature is discovered in the immediate area, and a communication plan to alert the Client, the Town Engineer, and the Contractor Supervisors of such discovery to allow the feature and potential impacts to be evaluated by a geotechnical representative from ANS Geo or other experienced geotechnical professional.

## 9. Mitigation Measurements for Karst Encountered During Construction

If an unanticipated karst feature is discovered during trenching or other construction activities, work in the immediate area should be immediately stopped and Concept Engineer Consultant and the Contractor's supervisors should be notified. Additional erosion and sedimentation controls should be installed as necessary to minimize the potential for surface water runoff intrusion into the karst feature. A geotechnical representative from ANS Geo or technical professional familiar with the project and with experience in karst terrain should be contacted and directed to the feature to conduct a detailed evaluation. If necessary, the geotechnical representative will develop a specific design and mitigation measures depending on the site conditions and nature of the identified karst feature.

If new sinkhole throats develop within the construction area while work is commencing, work in the area should be halted and the sinkhole area should be isolated and cordoned off to an area extending 100 feet radially from the feature. The sinkhole should be inspected by a geotechnical representative from ANS Geo or other experienced geotechnical professional, and remedial measures such as filling of the sinkhole using inverted filter approach or field-adjustment of the site developments may be implemented. The inverted filter approach is often used for sinkhole repair, especially when the sinkhole is not located near structures. The sinkhole area is excavated to expose either bedrock or the throat of the sinkhole. A course of rock large enough to bridge the throat of the sinkhole is placed at the bottom of the excavation. Subsequently, once the sinkhole throat has been "choked", a geotextile separation fabric is placed to line the bottom and sidewalls of the excavation, followed by placement of courses of progressively finer rock and gravel compacted above the base course. A geotextile fabric may be placed above the finest gravel course to prevent excessive loss of the uppermost course, which may consist of sand and/or soil. The inverted filter method provides filtration treatment of storm water and allows controlled storm water infiltration and groundwater recharge.

If an existing subsurface void is intersected within the work area, work should similarly be halted and cordoned off for further evaluation by a geotechnical representative from ANS Geo or other experienced geotechnical professional. As indicated earlier, the principal approach to maintain rates of recharge and discharge at pre- development conditions, a filter fabric secured over the void may be implemented in addition to an inverted filter.

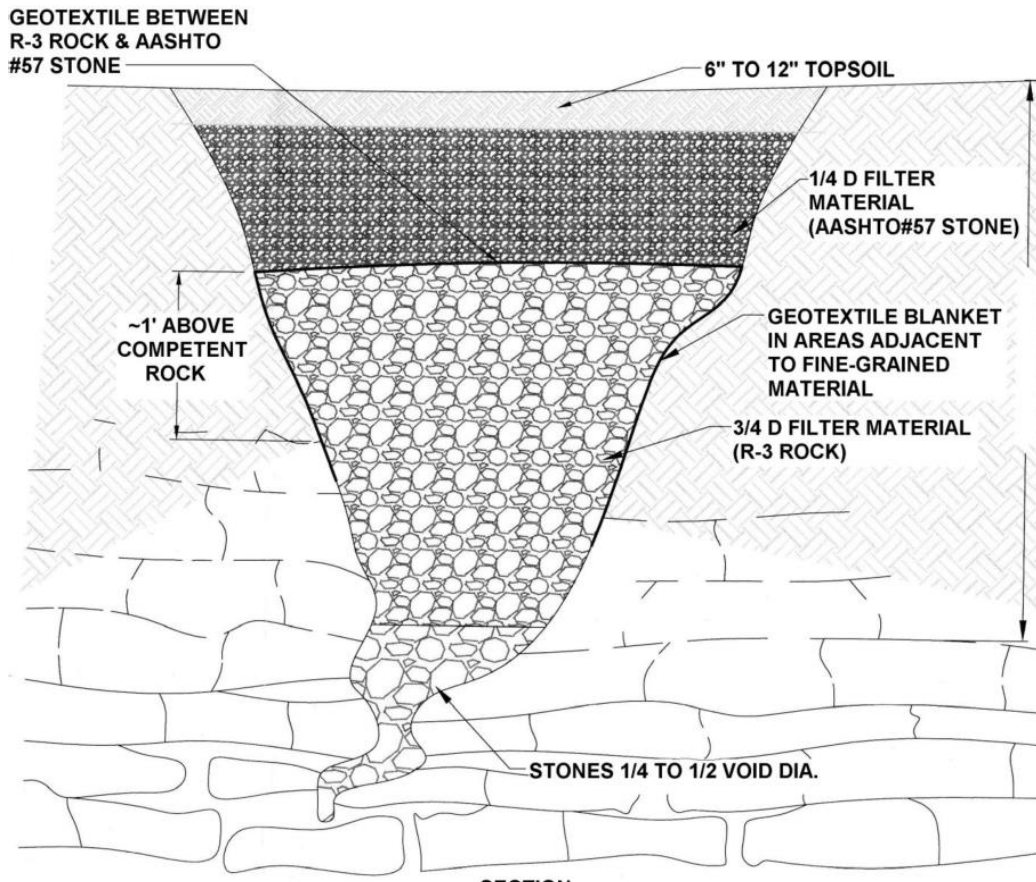
Commonly accepted methods to mitigate sinkhole collapses and similar subsurface voids which have been developed by state agencies such as the United States Geologic Survey (USGS), US Department of Agriculture Natural Resources Conservation Service (USDA NRCS), and Pennsylvania Department of Environmental Protection's (PADEP) are provided as Attachment 1 through 2 with this Plan. These typical details may be implemented depending on the karst feature encountered. The mitigation methods provided with this Plan would provide enhanced stability to the void and increase the long-term stability. Final grading of contours and any necessary permanent erosion and sediment controls should be designed to prevent runoff from accumulating in the area of the void.

## 10. References

1. Denton, R. K. Jr., 2013, Towards a Karst Assessment Standard Practice, Proceedings of the 13th Conference on Engineering and the Environment in Karst, National Cave and Karst Research Institute, Carlsbad, NM.
2. Devilbiss, T.S. (1995). A local government approach to mitigating impacts of karst. Karst GeoHazards, Berry Beck (ed.). Balkema, Rotterdam: 499-504.
3. Ford, D. C., and P. W. Williams, 1989, Karst Geomorphology and Hydrology, University Press, Cambridge, Great Britain.
4. Kastning, E.H. & Kastning, K.M. (1989). Sinkhole Management. Proceedings of the 1989 National Cave Management Symposium. Jordan, J. & Obele, R. (eds.). Texas Cave Management Association. New Braunfels, Texas: 54-68.
5. Kastning, E.H. & Kastning, K.M. (1997). Buffer Zones in Karst Terranes. Proceedings: KarstWater Environment Symposium, T. Younos, T Burbey, E. Kastning, & J. Poff (eds.). Virginia Water Resources Research Center, Virginia Tech: Pg. 80-87.
6. Kochanov, W.E. (1995). Storm-water management and sinkhole occurrence in the Palmyra area, Lebanon County, Pennsylvania. Karst Geohazards. Berry Beck (ed.). Balkema, Rotterdam: Pg. 285-290.
7. PADCNr, 1999, Kochanov, W.E. Bureau of Topographic and Geologic Survey, Sinkholes in Pennsylvania (Third Printing, Revised 2005). [http://www.dcnr.state.pa.us/cs/groups/public/documents/document/dcnr\\_014591.pdf](http://www.dcnr.state.pa.us/cs/groups/public/documents/document/dcnr_014591.pdf) Accessed on June 2, 2015.
8. Pennsylvania Department of Environmental Protection, March 2012, Erosion and Sediment Pollution Control Program Manual, Technical Guidance Number 363-2134-008. Accessed June 1, 2015
9. USEPA, 1989. Groundwater Monitoring in Karst Terranes, Recommended Protocols & Implicit Assumptions, EPA 600/X-89/050, February.
10. U.S. Geologic Survey (USGS). 2005. Mineral Resources Data System. Last Revised January 2012. Available at: <http://mrdata.usgs.gov/mrds/>.

# Attachment 1

## Sinkhole Repair with Pervious Cover Detail



**SECTION**

**NOT TO SCALE**

Source: Adapted from USDA NRCS

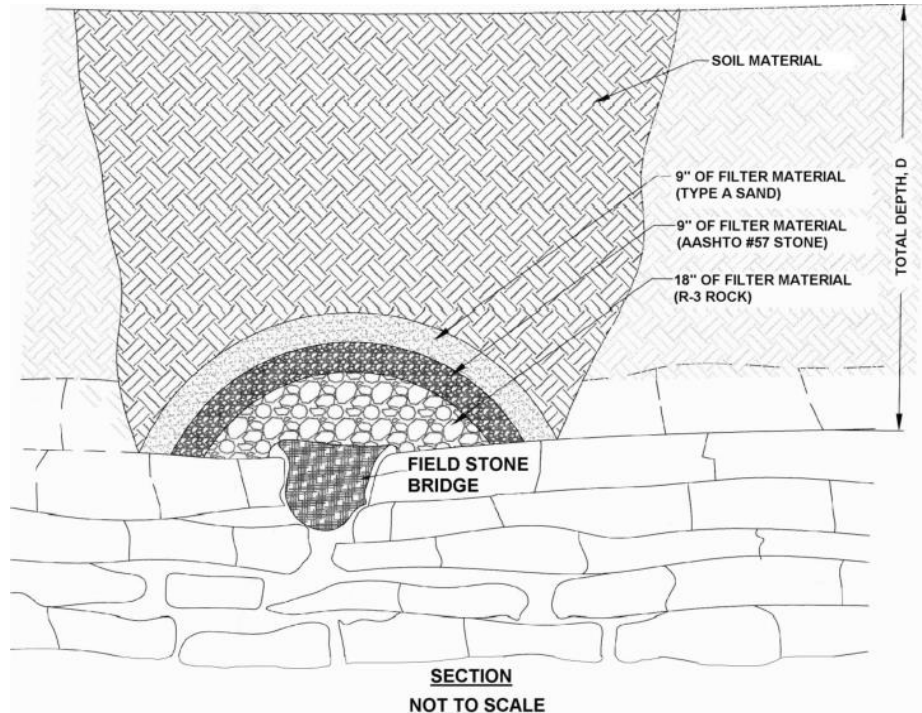
### Notes

1. Loose material shall be excavated from the sinkhole and expose solution void(s) if possible. Enlarge sinkhole if necessary to allow for installation of filter materials. OSHA regulations must be followed at all times during excavation.
2. Stones used for the “bridge” and filters shall have a moderately hard rock strength and be resistant to abrasion and degradation. Shale and similar soft and/or non-durable rock are not acceptable.



## Attachment 2

### USDA NRCS Sinkhole Repair with Soil Cover Detail



Source: Adapted from USDA NRCS

#### Notes:

1. Loose material shall be excavated from the sinkhole and expose solution void(s) if possible. Enlarge sinkhole if necessary to allow for installation of filter materials. OSHA regulations must be followed at all times during excavation.
2. Select field stone(s) about 1.5 times larger than solution void(s) to form "bridge." Place rock(s) so no large openings exist along the sides. Stones used for the "bridge" and filters shall have a moderately hard rock strength and be resistant to abrasion and degradation. Shale and similar soft and/or non-durable rock are not acceptable.
3. Minimum thickness of R-3 rock is 18" AASHTO #57 stone thickness shall be a minimum of 9" thick. Minimum thickness of type A sand shall be 9". NOTE: A non-woven geotextile with a burst strength between 100 and 200 psi may be substituted for the AASHTO#57 stone and type A sand.
4. Soil shall be mineral soil with at least 12% fines and overfilled by 5% to allow for settlement. Suitable soil from the excavation may be used. Any available topsoil shall be placed on top surface.